

The Solar System

by

Lieut.-Colonel Arthur E. Powell

DEDICATION

*This book, like its four predecessors,
is dedicated with gratitude and
appreciation to those whose labours
and researches have provided
the materials out of which
it has been wrought.*

CONTENTS

CHAPTER		PAGE
	INTRODUCTION	9
I.	GLOBES	11
II.	ROUNDS	14
III.	CHAINS	16
IV.	SCHEMES OF EVOLUTION	19
V.	THE SOLAR SVSTEM	22
VI.	THE BUILDING OF THE SOLAR SYSTEM	25
VII.	THE SOLAR LOGOS AND THE PLANETARY LOGOI	32
VIII.	THE LIFE-STREAMS	38
IX.	THE GOALS OF OUR SEVEN CHAINS	45
X.	DEGREES OF ATTAINMENT	49
XI.	RACES AND SUB-RACES	52
XII.	THE INNER ROUND	56
XIII.	"JUDGEMENT DAYS"	61
IV.	INVOLUTION AND EVOLUTION	71
XV.	TIMES AND DATES	75
XVI.	THE PLANETARY CHAIN LOGOI AND OTHER HIGH OFFICIALS	79
XVII.	MANUS	84
XVIII.	BUDDHAS, MAHACHOHANS AND BODHISATTVAS	89
XIX.	THE LORD OF THE WORLD AND HIS ASSISTANTS	92
XX.	THE EARTH SCHEME OF EVOLUTION: THE FIRST CHAIN	97
XXI.	THE SECOND CHAIN	101
XXII.	THE THIRD (MOON) CHAIN: THE FIRST FIVE ROUNDS	104
XXIII.	THE MOON CHAIN: SIXTH ROUND	110
XXIV.	THE MOON CHAIN: SEVENTH ROUND	114
XXV.	PRODUCTS OF THE MOON CHAIN	118
XXVI.	THE BUILDING OF THE EARTH CHAIN	128
XXVII.	THE EARTH CHAIN: THE FIRST ROUND	132
XXVIII.	THE EARTH CHAIN: THE SECOND ROUND	138
XXIX.	THE EARTH CHAIN: THE THIRD ROUND	140
XXX.	THE FOURTH ROUND: GLOBES A, B AND C	145
XXXI.	THE EARTH: THE FIRST ROOT-RACE	148
XXXII.	THE EARTH: THE SECOND ROOT-RACE	151
XXXIII.	THE EARTH: THE THIRD ROOT-RACE: LEMURIAN	154
XXXIV.	THE COMING OF THE LORDS OF VENUS	167
XXXV.	THE FOURTH (ATLANTEAN) ROOT-RACE: THE RMOAHAL	169
XXXVI.	THE SECOND ATLANTEAN SUB-RACE: THE TLAVATLI	174
XXXVII.	THE THIRD ATLANTEAN SUB RACE: THE TOLTEC	176
XXXVIII.	THE CIVILASATION OF ATLANTIS	183
XXXIX.	ANCIENT PERU: A TOLTEC REMNANT	193
XL.	THE FOURTH ATLANTEAN SUB-RACE: THE TURANIAN	201
XLI.	A TURANIAN RELIC: CHALDÆA, B.C. 19,000	202
XLII.	THE FIFTH ATLANTEAN SUB-RACE: THE ORIGINAL SEMITES	209
XLIII.	THE SIXTH ATLANTEAN SUB-RACE: THE AKKADIAN	210
XLIV.	THE SEVENTH ATLANTEAN SUB-RACE: THE MONGOLIAN	211
XLV.	BEGINNINGS OF THE FIFTH (ÂRYAN) ROOT-RACE	212

	PAGE
XLVI. THE CITY OF THE BRIDGE	216
XLVII. THE FIRST ÂRYAN SUB-RACE: THE HINDU: B.C. 60,000	218
XLVIII. THE SECOND ÂRYAN SUB-RACE: THE ARABIAN: B.C. 40,000	222
XLIX. THE THIRD ÂRYAN SUB-RACE: THE IRANIAN: B.C. 30,000	227
L. THE FOURTH ÂRYAN SUB-RACE: THE KELTIC: B.C. 20,000	232
LI. THE FIFTH ÂRYAN SUBRACE: THE TEUTONIC: B.C. 20,000	238
LII. THE FIFTH ROOT-RACE STOCK AND ITS DESCENT INTO INDIA: B.C. 18,800	241
LIII. THE ÂRYAN SIXTH SUB-RACE	245
LIV. THE SIXTH AND SEVENTH ROOT-RACES	248
LV. LIFE ON MARS AND MERCURY	260
LVI. CONCLUSION	263

LIST OF DIAGRAMS

	PAGE
I. GLOBES AND THEIR COUNTERPARTS (A)	11
II. GLOBES AND THEIR COUNTERPARTS (B)	12
III. THE 7 GLOBES OF THE EARTH CHAIN	12
IV. THE 7 ROUNDS OF THE EARTH CHAIN	14
V. THE 7 CHAINS OF THE EARTH SCHEME	16
VI. THE 7 CHAINS OF THE EARTH SCHEME AND THEIR PRELÂYAS	17
VII. THE EARTH SCHEME OF EVOLUTION	19
VIII. THE PLAN OF THE SOLAR SYSTEM	22
IX. THE SOLAR SYSTEM AS IT AT PRESENT EXISTS	23
X. THE 10 EXISTING CHAINS	23
XI. TATTVAS AND TANMÂTRAS	28
XII. RELATION OF PHYSICAL PLANETS TO THE SUN	35
XIII. FOURTH DIMENSIONAL CONNECTION BETWEEN SUN AND PLANETS	36
XIV. THE 13 LIFE-STREAMS AND THEIR PROGRESS	41
XV. THE LIFE-STREAMS OF SUCCESSIVE SCHEMES	41
XVI. THE GOALS OF OUR 7 CHAINS	47
XVII. DEGREES OF ATTAINMENT	49
XVIII. THE PROGRESS OF THE KINGDOMS	50
XIX. THE ROOT-RACES OF THE EARTH CHAIN	53
XX. THE RACES OF THE 7 EARTH-PERIODS	54
XXI. THE ROOT-RACES AND SUB-RACES OF OUR SCHEME OF EVOLUTION	54
XXII. THE PASSAGE OF THE LIFE-WAVE	56
XXIII. THE NUCLEI ON THE PLANETS	57
XXIV. THE INNER ROUND: RETROGRESSION	58
XXV. THE INNER ROUND: SPEEDING UP	59
XXVI. THE PRODUCTS OF THE EARTH CHAIN	65
XXVII. A ROOT-RACE JUDGEMENT DAY (FOURTH ORDER)	68
XXVIII. A GLOBE-PERIOD JUDGEMENT DAY (THIRD ORDER)	69
XXIX. JUDGEMENT DAYS IN ONE ROUND (FOURTH, THIRD AND SECOND ORDERS)	69
XXX. THE JUDGEMENT DAYS OF THE EARTH CHAIN	69
XXXI. THE DOWNWARD AND UPWARD ARCS	72
XXXII. THE INFLUENCES ACTING ON ONE PLANE (THE ASTRAL)	81
XXXIII. THE INFLUENCES ACTING ON THE 7 PLANES OF MATTER	82
XXXIV. THE "SERVERS" AND OTHER GROUPS IN THE MOON CHAIN	105
XXXV. EMERGENCE OF CERTAIN GROUPS OF THE MOON CHAIN	118
XXXVI. PRODUCTS OF THE MOON CHAIN	122
XXXVII. THE WORK OF THE BARHISHADS IN THE EARTH CHAIN	129
XXXVIII. THE EARTH CHAIN: FIRST ROUND	134
XXXIX. THE EARTH CHAIN: ROUNDS 1, 2 AND 3	140
XL. THE THIRD ROOT-RACE (LEMURIAN)	156
XLI. EVOLUTION OF ROOT-RACES FROM SUB-RACES	171

	PAGE
XLII. THE CITY OF THE GOLDEN GATES	186
XLIII. A CHALDÆAN TEMPLE	205
XLIV. ARRANGEMENT OF MIRRORS IN A CHALDÆAN TEMPLE	205
XLV. THE FIFTH ROOT-RACE AND THE FIRST MIGRATION (SECOND SUB-RACE)	213
XLVI. THE THIRD AND FOURTH SUB-RACES	227
XLVII. THE FIFTH AND FIRST SUB-RACES	238

AUTHORS QUOTED

BOOK	AUTHOR	EDITION	ABBREVI- ATION
Astral Plane	C. W. Leadbeater .	1910	<i>A P</i>
Changing World . . .	A. Besant	1909	<i>C W</i>
Devachanic Plane . .	C. W. Leadbeater .	1902	<i>D P</i>
Hidden Side of Things, Vol. 1.	C. W. Leadbeater .	1913	<i>H S I</i>
Initiation the Perfecting of Man.	A. Besant	1912	<i>I P M</i>
Inner Life. Vol. 1. . .	C. W. Leadbeater .	1910	<i>I L I</i>
Inner Life, Vol. 11. . .	C. W. Leadbeater .	1911	<i>I L II</i>
Man : Whence. How and Whither ?	Besant and Lead- beater.	1913	<i>M W</i> <i>H W</i>
Masters and the Path . .	C. W. Leadbeater .	1927	<i>M P</i>
Pedigree of Man	A. Besant	1904	<i>P M</i>
Pyramids and Stonehenge .	A. P. Sinnett . . .	1912	<i>P S</i>
Story of Atlantis and Lemuria.	W. Scott-Elliott .	1925	<i>S A L</i>
Seven Principles of Man .	A. Besant	1904	<i>S P</i>
Talks on the Path of occultism.	A. Besant and C. W. Leadbeater.	1926	<i>T P O</i>
Textbook of Theosophy . .	C. W. Leadbeater .	1914	<i>T B</i>
Theosophy	A. Besant	-	<i>T</i>

PUBLISHER'S PREFACE

THE author's purpose in compiling the books in this series was to save students much time and labour by providing a condensed synthesis of the considerable literature on the respective subjects of each volume, coming mostly from the pens of Annie Besant and C. W. Leadbeater. The accompanying list shows the large number of books from which he drew. So far as possible, the method adopted was to explain the form side first, before the life side: to describe the objective mechanism of phenomena and then the activities of consciousness that are expressed through the mechanism. There is no attempt to prove or even justify any of the statements.

The works of H. P. Blavatsky were not used because the author said that the necessary research in *The Secret Doctrine* and other writings would have been too vast a task for him to undertake. He added: "The debt to H. P. Blavatsky is greater than could ever be indicated by quotations from her monumental volumes. Had she not shown the way in the first instance, later investigators might never have found the trail at all."

INTRODUCTION

BOTH before and since the publication in 1888 of *The Secret Doctrine*, by H. P. Blavatsky, there has become available for students of occultism a good deal of information regarding the Solar System and the streams of life-amongst which is our own humanity-which evolve in that System. In 1883 appeared *Esoteric Buddhism* by A. P. Sinnett, followed in 1896 by *The Growth of the Soul* by the same author. In 1897 was published *The Ancient Wisdom* by Annie Besant, and in 1903 this great student of the occult delivered an important series of lectures, afterwards published in book form, under the title *The Pedigree of Man*, dealing in greater detail than anything previously published with the Solar System, with its Chains, Rounds, Globes, Races, Sub-races, etc. Further elaboration and details have been added by C. W. Leadbeater in various, books, notably *The Inner Life*, Volumes I and II, and *A Textbook of Theosophy*.

In 1913 appeared, *Man: Whence, How and Whither?* In addition to these, two fascinating volumes, entitled *The Story of Atlantis and Lost Lemuria*, with maps of those continents, from the pen of W. Scott-Elliott, appeared in 1896 and 1904 respectively, describing in very full detail the races that inhabited those lands, and their civilisations.

Up to the present, however, no one book has appeared covering the whole of this vast ground, describing both the "field" of evolution and the streams of life which evolve in it as the ages roll by.

The present volume is therefore an attempt to fill this need. The whole of the information it contains is to be found in the volumes already mentioned, or in certain others, the complete list being given on page 7.

In view of the complexity of the subject, and its many details, a large number of diagrams, most of which are original, have been included in the text, and it is hoped that these will facilitate the work of the student in mastering the many intricacies of the system to which we belong and the method under which our evolution proceeds. Some tabular statements and summaries have been added, with the same purpose in view.

In order to keep the book within reasonable dimensions, many details, such, for example, as those concerned with the civilisations of the various races in Atlantean and Lemurian times, have been omitted. These details, however, are readily accessible to the student, the places where they are to be found having invariably been given in the text, which contains only a summary of their leading features.

Such omissions do not in any way interfere with or break the continuity of the story as told in this book. Their inclusion would, in fact, probably have made the picture too complicated and elaborate to be grasped in one treatise, so that the student would have been in danger of losing sight of the "forest" because of the number of the "trees."

The aim of the present volume is to give a co-ordinated and coherent view of the, "forest" rather than to describe in detail

each particular "tree." The student may then, as his leisure permits, and his tastes impel, study for himself the histories of the separate trees, bushes, thickets, and so on, which, collectively, make up the gigantic forest of lives which populate the amazing world, or rather series of worlds, in which we have our being and evolve.

The work is planned in three main sections. First, the field, in which evolution takes place, is described. This involves a study of the various globes, their successive periods of activity and obscuration, the chains, and schemes of evolution. It is the form side of our subject, a description of the places where life evolves. The second section deals with the various streams of life which are poured into the prepared field, and the method by which those streams steadily evolve and pass through the various stages or levels of attainment or growth. These processes are here dealt with in, broad outline only, giving the student a bird's-eye view of the whole stately march of events.

The third section describes in much more detail the progress of the component parts of certain of the kingdoms of life, more especially the human races and subraces. In this section, however, as already stated, full elaboration of detail is avoided, the object being, not so much to give the student an encyclopedic mass of information, as to enable him to perceive and understand the principles determining the mighty plan in obedience to which everything is ordered in this superbly ordered universe, in which "not a sparrow falls on the ground" save by the will of the Father of the System to which we have the honour to belong.

THE SOLAR SYSTEM

CHAPTER I GLOBES

WE shall commence our study of the "field" in which evolution takes place, with the small unit, and proceed to build up the larger units out of the smaller, i.e., we shall pass from the particular to the general. This, it is considered, will be easier for the student than the reverse method of commencing with the large unit, and then dividing it up into its component and smaller units. Later, however, when we come to investigate the life which evolves in the "field" we shall find it easier to adopt the reverse method, and, commencing with the large streams of life, proceed to divide them up into their component and smaller units. Thus we adapt our methods to the nature of our subject.

The earth and the other planets are known as globes. Our own earth is one of a series of 7 globes: that series is known as a chain, and the earth is the densest of the 7 globes of its chain.

The 7 globes of the earth chain consist of:

- 2 lower mental globes.
- 2 astral globes.
- 3 physical globes.

The globes of every chain are not necessarily so constituted: but with that we shall deal in full detail presently.

When we speak, for example, of a lower mental globe, we mean one in which the densest type of matter it contains is lower mental: i.e., it has no astral or physical matter. Similarly, an astral globe has no matter denser than the astral, i.e., it has no encasement of physical matter.

Each globe, however, possesses "counterparts," as they are called, of the various grades of matter finer than itself: thus, a physical globe possesses its counterparts of astral, lower mental, higher mental, buddhic, and âtmic matter: an astral globe possesses a lower mental and all the higher matter counterparts. These facts may be symbolised thus (Diagram 1).

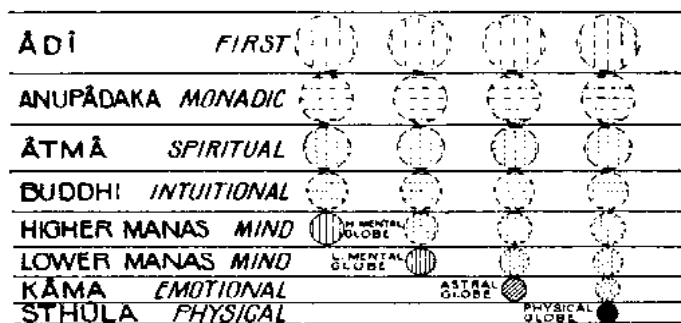

DIAGRAM I.—Globes and their Counterparts (A).

Any one globe, however, must not be imagined as occupying a position in space separate and distinct from its counterparts,

because this is not the case. The counterparts of a globe occupy identically the same position in space as the globe itself, with this reservation, that the spheres of higher or finer matter are larger than those of lower matter, for they interpenetrate and extend beyond the periphery of the lower matter spheres, just as a man's astral body interpenetrates and extends beyond the confines of his physical body, his mental body beyond that again, and so on. A truer representation of the globes would therefore be as shown in Diagram II.

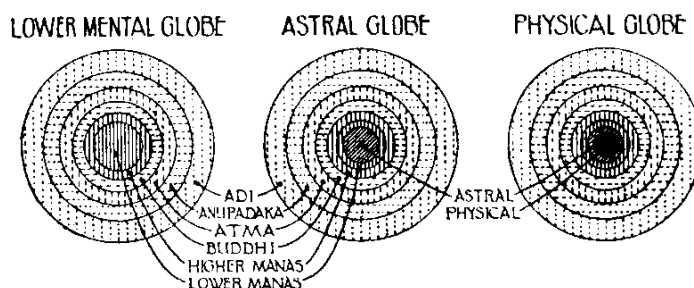

DIAGRAM II.—Globes and their Counterparts;(B).

It is well known to students of science that particles of matter never actually touch one another, even in the densest substances. Moreover, the spaces between the particles are always far greater than the size of the particles themselves. Hence there is ample room, in any given portion of space, for every grade of atom, not only to lie between the atoms of denser matter, but also to move about quite freely among them and around them.

Consequently a physical globe, such as the earth, is not one world, but 7 interpenetrating worlds, all occupying the same space, except that, as said, the finer types of matter extend further from the centre than do the denser types.

The 7 globes of a chain are, by recognised convention, known respectively as Globes A, B, C, D, E, F and G. In the earth chain, Globes A and G are lower mental, B and F are astral, C, D, and E are physical; C is the planet Mars, D is the Earth, and E

is the planet Mercury. A, B, F and G have at present no names other than the letters which designate them.

Diagram III represents the 7 globes of the earth chain. The Hindu Purânas speaks of the globes of our chain as Dvîpas, the earth being called Jambudvîpa.

Each of the 7 globes, being a separate and distinct planet, may be regarded as having a definite location in space,

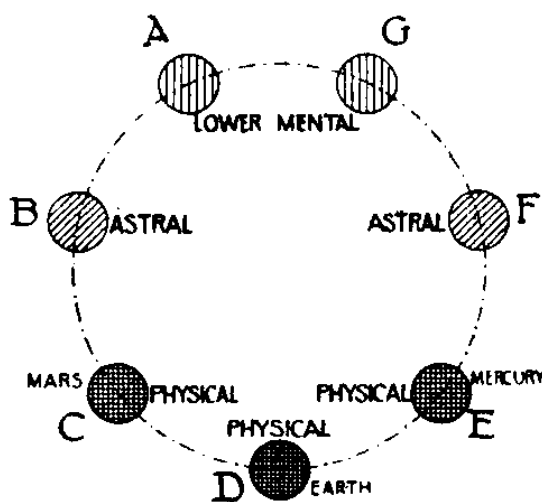

DIAGRAM III.—The Seven Globes of the Earth Chain.

revolving round, or in some way dependent upon, our sun.

The student will kindly observe and note the various kinds of shadings used to designate the different orders of matter, as these shadings will be used throughout this book, wherever convenient, for the purpose named.

The physical being the densest, is represented by crossed lines. The astral, as being between the physical and the mental, is shown by lines inclined at 45° to the horizontal; the lower mental is represented by vertical lines, the higher mental by similar lines though further apart.

Buddhic matter is indicated by horizontal dotted lines, and âtmic matter by vertical dotted lines.

It is not easy for us to attach any meaning to the idea of a planet upon planes so exalted as the nirvânic (âtmic) or buddhic, and we are perhaps scarcely justified in using the term. All that is meant is that there is a certain location in space where the evolution of certain groups of entities is taking place through agencies which work on those exalted levels.

CHAPTER II

ROUNDS

ALTHOUGH the 7 globes of a chain all exist simultaneously, yet they are not all, at any given time, equally active in supporting life. Broadly speaking, at any given time, 1 globe only is active and fully functioning, the other 6 being in a dormant condition.

The globes come into full activity, i.e., they become fully inhabited by various classes of beings—with whom we shall deal in later chapters—in succession. First, globe A becomes active: after a vast period of time the life on it begins gradually to lessen and almost to disappear, passing to the next globe—B. Globe A then becomes dormant, whilst B begins to awaken.

After another vast period of time, globe B in turn "goes to sleep," the greater part of the life passing on to the next globe in order, globe C.

This process continues until each globe in turn has awakened from its sleeping condition, has supported the main stream of life for an eon, and again become dormant. The period during which a globe is fully active, supporting the main stream of life, is called a globe-period.

The passage of the cycle of life round all 7 globes is known

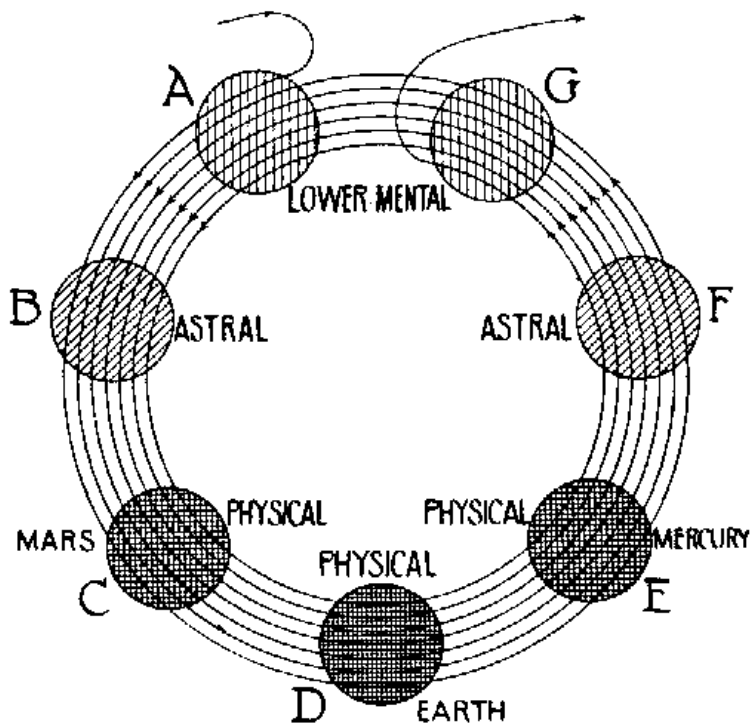

DIAGRAM IV.—The Seven Rounds of the Earth Chain.

as a round. A round thus consists of 7 globeperiods, or

worldperiods, as they are sometimes called.

When one round has been completed, the whole process begins again with the re-awakening of life on Globe A, its subsequent passage to Globe B, then to Globes C, D, E, F and G successively until a second round has been completed. The whole process is then repeated until 7 rounds have been completed.

Diagram IV illustrates the 7 rounds of the earth chain, the spiral line indicating the stream of life which passes 7 complete times round the whole chain of 7 globes.

We thus see that:

7 globe-periods make 1 round,
and 49 globe-periods make 7 rounds or 1 chain-period.

We spoke above of each globe in succession passing, as the stream of life leaves it, into a dormant condition. When this happens, the life on the globe does not entirely cease: a small amount of life, a kind of nucleus, always remains, and serves several important purposes. We shall deal with this phenomenon later in its proper place. It is merely mentioned here in order to prevent the student from forming an inaccurate conception of what really takes place.

CHAPTER III

CHAINS

As we have just seen, a chain consists of 7 globes, each of which has 7 periods of activity, so that 49 globe-periods make up 1 chain-period.

When the chain-period is completed, the globes which form it disintegrate, and the matter which composed them is re-formed to make 7 new globes. These 7 new globes then pass through 7 rounds of activity, precisely as before, and are then broken up, only to be re-formed once more into another set of 7 globes.

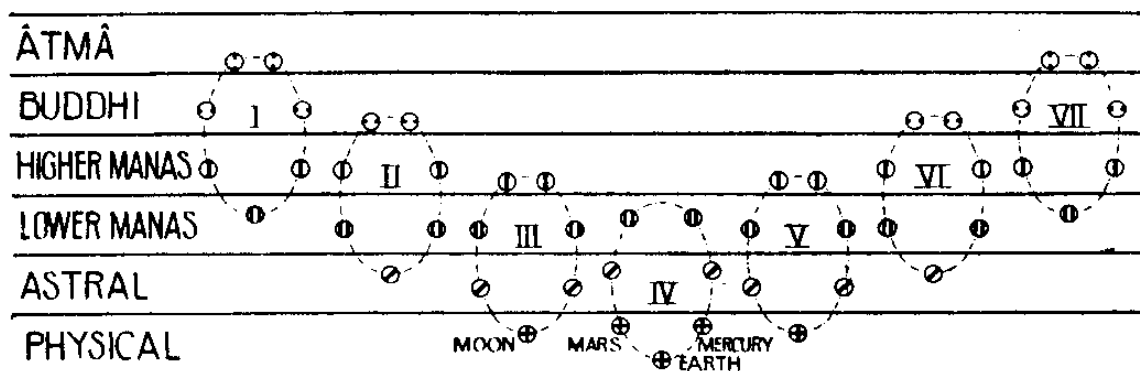

DIAGRAM V.—The Seven Chains of the Earth Scheme.

The process takes place 7 times, 7 chains, each consisting of 7 globes, being thus formed in succession, and each lasting for its 7 rounds of activity.

The individual globes, which are formed from the disintegrated matter of the preceding chain, although formed of the same ultimate material particles, are not composed of the same grades of matter. Diagram V makes clear what happens. The first chain is formed of

- 2 globes of âtmic matter,
- 2 globes of buddhic matter,
- 2 globes of higher mental matter,
- 1 globe of lower mental matter.

The second chain descends a step, in the order of its matter, so that it has

- 2 globes of buddhic matter,
- 2 globes of higher mental matter,
- 2 globes of lower mental matter,
- 1 globe of astral matter.

The third and fourth chains plunge still lower into matter, as indicated in Diagram V.

The diagram brings out several points of interest, which are worthy of note. Thus, out of the 49 globes in the whole series of 7 chains,

4 are âtmic,
 8 are buddhic,
 12 are higher mental,
 12 are lower mental,
 8 are astral,
 5 are physical.

Thus only the first and seventh chains have purely âtmic globes; only the second and sixth have purely buddhic globes; all but the fourth chain have higher mental globes; all but the first and seventh have lower mental globes; only the third, fourth and fifth chains have physical globes.

The central plane of the five planes is the mental, and this plane alone is divided into two portions. Every one of the 7 chains has representative globes on the mental plane; all but the fourth chain, in fact, having representatives on both the higher and the lower mental planes.

From this consideration, it is clear that the mental plane plays a part of great importance in man's evolution: for, of the whole 49 globes, 24, or nearly half, are on the mental plane. Hence the appropriateness of the occult definition of man as "that being in the universe, in whatever part of the universe he may be, in whom highest Spirit and lowest Matter are joined together by *Intelligence*."

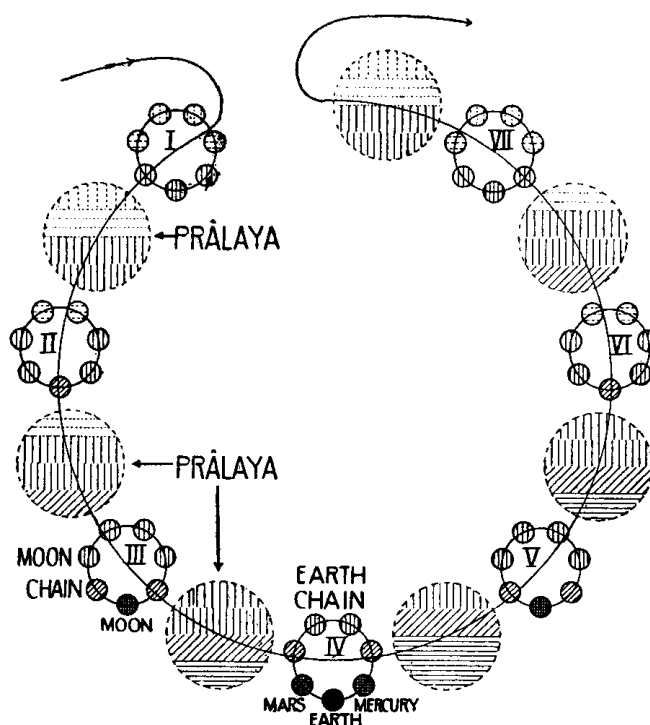

DIAGRAM VI.—The Seven Chains of the Earth Scheme and their Prālayas.

So we may say also that in the series of 7 chains, the highest spiritual is joined to the lowest material by mental matter, the substance of intelligence. The disintegration of the globes into their component materials, and their re-integration into 7 new globes at a lower or higher level, as the case may be,

is illustrated in Diagram VI.

The period between any two successive chains, during which the matter of the previous chain is in a state of disintegration, is known as the *prâlaya* of the chain, or the inter-chain *prâlaya*.

The whole series of 7 chains makes up what is called a *Scheme of Evolution*, or sometimes merely a *Scheme*.

We therefore now have this table:

7	globe-periods	=	1	round,
49	- " -	=	7	rounds = 1 chain-period,
343	- " -	=	49 - " -	= 7 chain-periods = 1 Scheme of Evolution.

We may note in passing that, as indicated in Diagram V, we are at present in the fourth chain of our Scheme of Evolution, and therefore at its lowest level of materiality. The precise point in that chain which we have now reached is, however, so important as to deserve separate consideration at a later stage of our study.

The 7 successive chains are sometimes spoken of as "incarnations" of the chain. Chains are spoken of also as Planetary Chains.

A chain may be regarded as the *Upâhi* or vehicle of the Planetary Logos—an Entity who will be described in a later chapter. We may think of the Planetary Logos re-incarnating Himself in the 7 successive chains, each chain beginning with the fruitage of its predecessor, each handing on to its successor that which itself has made.

In the first 3 chains we may say Spirit or Life descends into matter; in the fourth chain Spirit and, Matter are interwoven and form innumerable relations; the last 3 chains are those of upward climbing, at the end of which all will return to the Planetary Logos, to merge into *Îshvara* with the fruitage of evolution.

CHAPTER IV

SCHEMES OF EVOLUTION

IN the preceding chapter we saw that 7 successive chains, or 7 incarnations of a chain, make up a scheme of evolution.

A scheme of evolution is, in the main, a separate, distinct and self-contained field of evolution, though certain very important modifications of this general principle will be explained later.

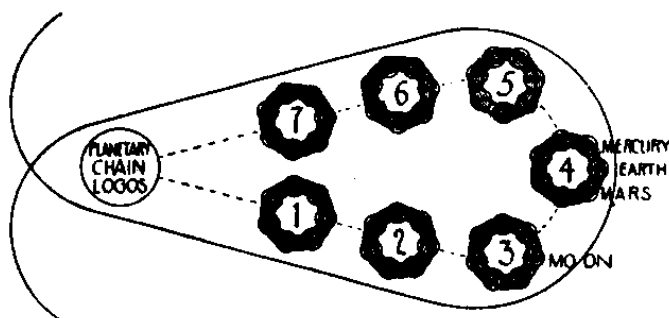

DIAGRAM VII.—The Earth Scheme of Evolution.

Diagram VII illustrates the Earth Scheme of evolution, showing the 7 chains, each containing 7 globes, the 7 rounds of each chain being indicated by the circles running through the globes.

Be it noted, however, that although the whole 49 globes of the Scheme are shown in the diagram, not more than one set of 7 is usually in existence at any given time (save for a few "corpses," like our Moon, which have not completely disintegrated).

In the diagram, Mars, the Earth and Mercury are shown as belonging to the fourth chain, the Moon to the third chain.

What we now call the Moon is the last remnant of a much larger globe, which was the physical planet of the third chain, holding the same position in the third chain that the Earth holds in the fourth chain. In the seventh round of the Earth Chain, the Moon will disintegrate entirely, so that the Earth will be without a satellite.

In our solar system there are 10 separate and distinct Schemes of Evolution. The names by which they are known are those of the physical planets which, at the present time, happen to be part of them. The 10 schemes are:

- (1) The Vulcan Scheme.
- (2) The Venus Scheme.
- (3) The Earth Scheme.
- (4) The Jupiter Scheme.
- (5) The Saturn Scheme.
- (6) The Uranus Scheme.
- (7) The Neptune Scheme.
- (8)-(10) Have no names at present, as they have no physical

planets. No. 8 is sometimes called the "Asteroids" Scheme.

The present stage of the 10 schemes is shown in the table on this side. The schemes are arranged in order of the nearness of their physical planets to the Sun.

The statement that in our seventh round our satellite, the Moon, will entirely disappear seems to be paralleled by a similar phenomenon in the case of the Venus Chain. The Venus Chain, being now in its seventh round, has no satellite. But some 150 years ago a number of astronomers recorded observations of a satellite of Venus, with a diameter estimated at 2,000 miles. Although it is usually supposed that those astronomers were mistaken, it seems more probable that the satellite did exist when they made their observations, but has since then disappeared, as will our own satellite in our seventh round.

It is stated that the material now forming the Asteroids will some time be made into a globe, which has been tentatively allocated to Scheme VIII. If we prefer to call this the Asteroids Scheme, it would come between the Earth and the Jupiter Schemes, the schemes being arranged in the order of the distances of their physical planets from the Sun.

No.	Scheme	Chain	Round	Number of Physical Planets	Notes
I.	Vulcan	3	6(?)	1	Will produce entities at a lower level than those of the Earth Scheme.
II.	Venus	5	7	1	The most advanced Scheme
III.	Earth	4	4	3	The 3 planets are Mars, the Earth and Mercury.
IV.	Jupiter	3	2	1	Jupiter is not yet inhabited, but its moons are. It will attain to a very high level.
V.	Saturn	3	early	1	Evolves slowly, but will reach a high level.
VI.	Uranus	3		1	
VII.	Neptune	4		3	The three planets are Neptune and two others beyond his orbit.
VIII.	Un-named			0	
IX.	Un-named			0	
X.	Un-named			0	

In spite of the enigmatical statement by H. P. Blavatsky that Neptune is not in our solar system, there is no question that Neptune does revolve round the sun, and that the Neptunian Chain is part of our system, being one of the 10 chains. Experience having shown that many of the statements of H. P. Blavatsky, apparently contrary to known facts, have later proved

to be true in some deeper and more esoteric sense, it may well be that her statement regarding Neptune will also eventually be found to be accurate, in some esoteric sense.

In *The Secret Doctrine* (Third Edition, Vol. I, pp. 186 - 190), there are emphatic statements that Mars and Mercury do not belong to the Earth Chain. The statements, made by Dr. Besant and by Bishop Leadbeater, that they do belong to the Earth Chain, have been warmly challenged by certain occult students (vide *The Mahatma Letters to A. P. Sinnett*, compiled by A. T. Barker, 1923, Introduction, p. XIII, and Appendix, pp. 489-492). The present writer does not attempt to reconcile these apparently irreconcilable statements, but here follows those of the two later writers named, because his work is essentially a compilation of their works, rather than those of H. P. Blavatsky (vide Conclusion, p. 352).

In addition to these 10 schemes, there are also other evolutions taking place in the solar system, every inch of space being utilised.

Even in the koilon itself there may be proceeding an evolution of which we know nothing and can imagine nothing.

All space is filled with life, and there are even orders lower than that of the physical plane. Occasionally a human being may come into touch with that lower evolution, but such entanglement is always undesirable and harmful. That is not necessarily because the lower evolution is in any way to be regarded as evil, but because it is not meant for our humanity.

CHAPTER V

THE SOLAR SYSTEM

DIAGRAM VIII represents the solar system, with its 10 schemes of evolution, each consisting of 7 chains of 7 globes, the 7 rounds

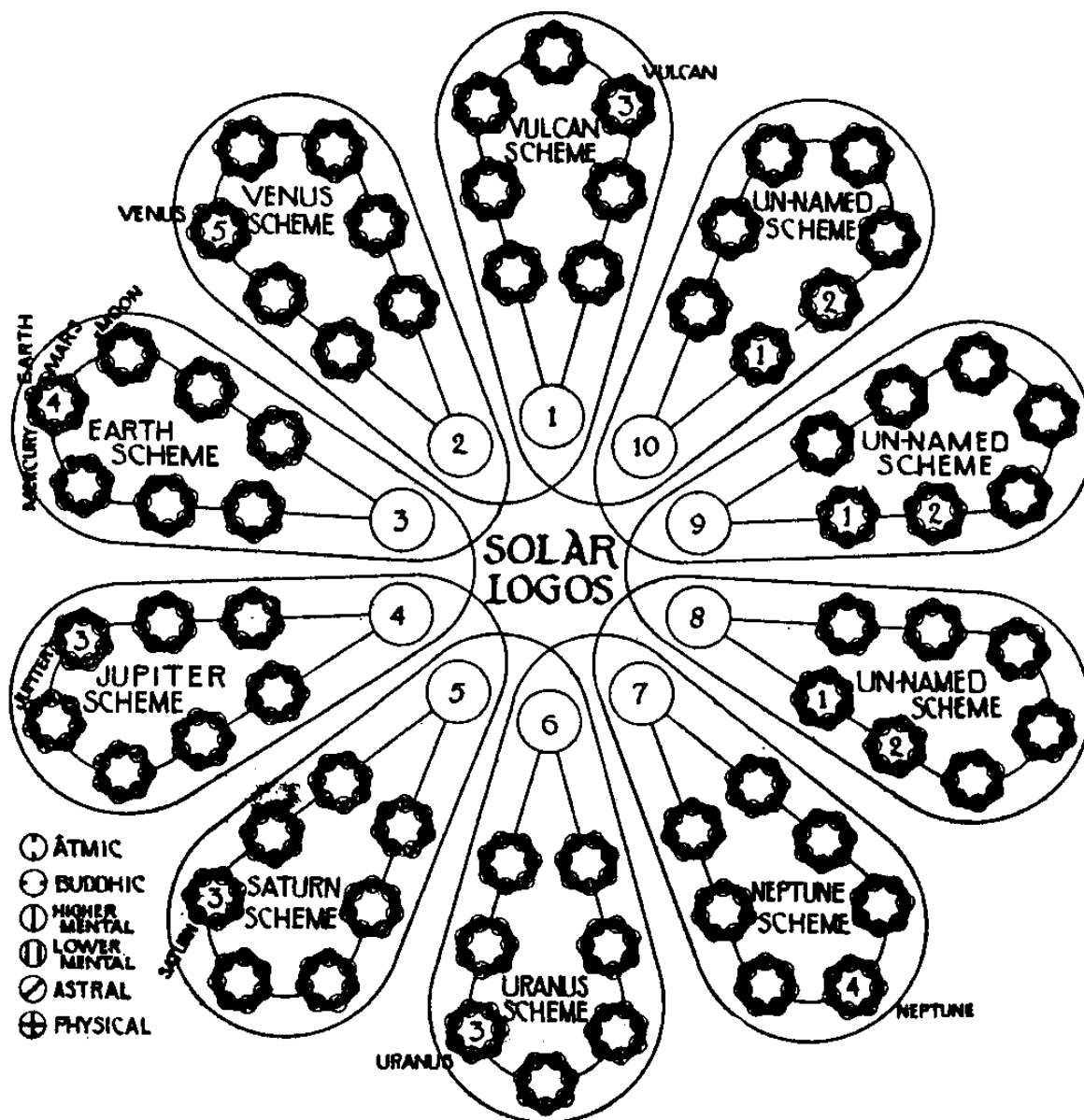

DIAGRAM VIII.—The Plan of the Solar System.

of each chain being indicated, as before, by the circles drawn through the globes.

The student will by now have clearly realised that, as the 7 chains of each scheme come into existence *successively*, Diagram VIII does not represent the solar system as it is at the present time, but is a collective picture of the stages through which it passes.

The actual state of the solar system at the present time is indicated in Diagram IX. The round on which each chain is at

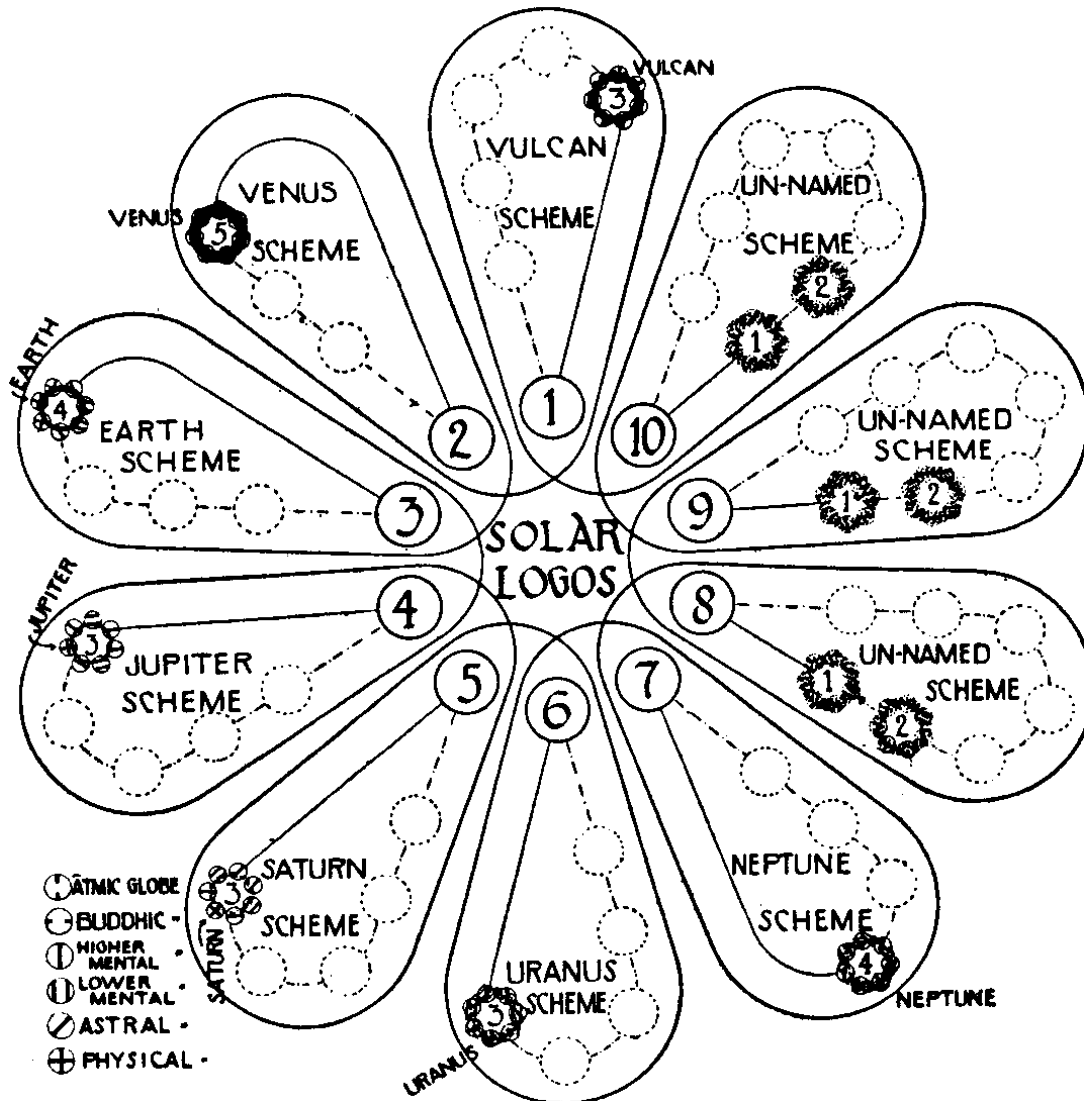

DIAGRAM IX.—The Solar System as it at present exists.

present engaged is shown, where it is known; where it is not known, the rounds are dotted. The chains of schemes 8, 9 and 10 are also shown dotted, as their present stage is not known.

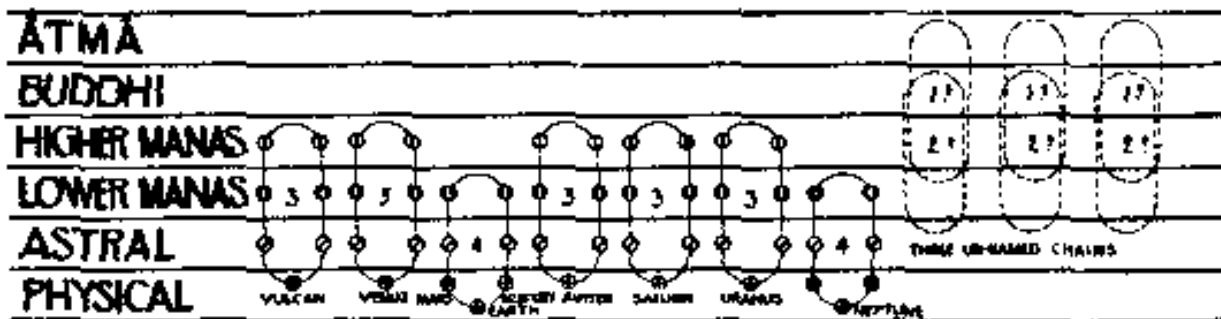

DIAGRAM X.—The Ten Existing Chains.

The solar system at present therefore has 70 planets which, as previously said, may be regarded as having a definite location in space, and as revolving round, or in some way depending upon, our sun. These 70 planets are shown in Diagram X. We may now make our final table as follows:

7	globe-periods	=	1	round.
49	"	=	7	rounds = 1 chain-period.
343	"	=	49	" = 7 chain-periods = 1
				Scheme of Evolution.
10	Schemes of Evolution	=	our	Solar System.

CHAPTER VI

THE BUILDING OF THE SOLAR SYSTEM

HAVING now studied, in broad outline, the general plan of the, "field" of evolution in our solar system, it will be useful to go over the ground again, filling in certain further details, and considering also the way in which the system is originally constructed out of primordial matter.

This time we shall commence with the large unit - the system as a whole - and steadily work our way down to the smaller units - the globes.

Before our solar system came into existence there existed the ultimate root-matter, the substance out of which will be fashioned every type of matter of which we have any knowledge. This root-matter is what scientists call the ether of space, and what has been described in *Occult Chemistry* under the name of koilon (Greek Koilos, hollow).

This must not, of course, be confused with the etheric matter which composes the finer part of our physical world.

To every physical sense, the space occupied by koilon appears empty: yet in reality this ether is far denser than anything of which we can conceive. Professor Osborne Reynolds, the originator of the celebrated theory, which agrees with occult investigation, defines its density as being 10,000 times greater than that of water, and its mean pressure as 750,000 tons to the square inch.

This substance is perceptible only to highly developed clairvoyant power. We must assume a time - though we have no direct knowledge on the point - when this substance filled all space. We must also suppose that some great Being - almost infinitely higher than the Logos of a solar system - changed this condition of rest by pouring out His spirit or force into a certain section of this matter, a section the size of a whole universe.

The effect of the introduction of this force is as that of the blowing of a mighty breath, forming within the ether, or koilon, an incalculable number of tiny spherical bubbles. These bubbles in koilon are the ultimate atoms out of which everything that we call matter is manufactured.

They are the atomic matter of the lowest cosmic plane. Out of them the Logos of our solar system will presently form the seven planes of our system, those seven planes, taken together, forming the lowest cosmic plane.

It is probable that the force by which the bubbles were originally formed is what H. P. Blavatsky called *fohat*, which she spoke of as "digging holes in space," thus reminding one of the recent dictum of a French scientist that "there is no matter; there are nothing but holes in the æther."

The bubbles are not like a soap-bubble, which is a film of water with an outer and an inner surface, enclosing air within it. They are like bubbles in sodawater, which have only one surface, where the air meets the water.

As has just been said, to the highest sight available the bubbles appear to be perfectly empty, so that it is not known

whether any motion is going on inside them or not. Neither is it known whether they are rotating on their axes or not.

They seem to have no proper motion of their own, but they can be moved as a whole from without, singly or *en masse*, by an exertion of the will. No two bubbles ever under any circumstances touch each other.

When the Solar Logos - the great Being of Whom our solar system is some representation, corresponding possibly to an incarnation, in the case of a human being - chose to manifest Himself, when He came forth out of eternity into time, and wished to form this system, He found ready to His hand this material, this infinite mass of tiny bubbles.

He commenced by defining an area, the limit of His field of activity, the limit, perhaps, of His own aura, a vast sphere, whose circumference is far larger than the orbit of the outermost of His future planets.

Stupendous as this area would be, the distance between solar systems is yet out of all proportion greater than the systems themselves. Nevertheless, it is probable that the Logoi of the systems are actually in touch with one another, on the higher planes.

Within the limit of the sphere thus marked out He sets up a motion which sweeps together all the bubbles into a vast central mass, thus condensing or compressing the bubble-matter, which was originally scattered throughout the whole of the prodigious space, into a smaller region.

At a certain stage in that condensation, or compression - a stage when the radius of His globe still extended far beyond the orbit of the outermost planet of the system, as it exists to-day - He sets up within it a whirling motion, accompanied by intense electrical action, thus making a colossal vortex in many dimensions, the material of the nebula that is to be.

The compression of the whirling mass is continued through what to us would be untold ages: in fact, the vortex made by the Logos in the first place is still in action. In the course of that process of compression, He, acting through His Third Aspect, sends out seven impulses or "breaths."

The first impulse sets up all through the sphere a vast number of tiny vortices, each of which draws into itself 49 bubbles, and arranges them in a certain shape. These little groupings of bubbles, so formed, are the atoms of the second plane or world - the anupâdaka or monadic plane.

The whole of the bubbles are not used in this way, but sufficient are left, in the disassociated state, to act as atoms of the first or âdi world.

In due time there comes a second impulse, which seizes upon nearly all the 49-bubble atoms - leaving sufficient to provide atoms for the anupâdaka world draws them back into itself, disintegrates them into their component bubbles, and then, throwing them out again, sets up among them vortices, each of which holds within itself 49^2 or 2,401 bubbles. These are the atoms of the third world, the plane of âtmâ.

Again after a time comes a third impulse, which in the same way seizes upon nearly all the 2,401-bubble atoms - again leaving sufficient to form the atoms of the âtmic world - draws them back into itself, disintegrates them, and throws them out once more as

the atoms of the fourth world, that of buddhi, each atom now containing 49^3 or 117,649 bubbles.

The process is repeated until the sixth impulse has built the atoms of the seventh or lowest world, the physical plane, its atoms containing 49^6 , or approximately 14,000 million of the original bubbles. These atoms are not, of course, the atoms of which chemists speak, but the *ultimate* atoms out of which all the chemical atoms are made.

The numbers of bubbles contained in the atoms of our seven planes are given in the following table:

Plane	³	
	³	
Âdî	³ 1	1
Anupâdaka	³ 49	49
Âtmâ	³ 49^2	2,401
Buddhi	³ 49^3	117,649
Manas (mental)	³ 49^4	5,764,800
Kâma (astal)	³ 49^5	282,475,249
Sthûla (physical)	³ 49^6	13,841,287,201
	³	

It seems probable that electrons are astral atoms: for it is stated by scientists that a chemical atom of hydrogen contains from 700 to 1,000 electrons, and a chemical atom of hydrogen contains the equivalent of 882 astral atoms. This may be a coincidence, but that seems unlikely. Scientists thus appear to be disintegrating physical matter and discovering astral matter, though they will naturally think of astral matter as being a further subdivision of physical matter.

Bishop Leadbeater, from whose writings the above is quoted, does not know whether such disintegrated physical atoms re-form themselves, but when, by an effort of will, the physical atom is broken up into astral or mental atoms, it requires a continuation of the effort to hold the atoms temporarily in those different forms, and when the will-force is withdrawn the physical atom reappears.

This, however, seems to apply only to the breaking up of the ultimate physical atoms: when chemical atoms are broken into ultimate atoms, they remain in that condition, and do not return to their original state.

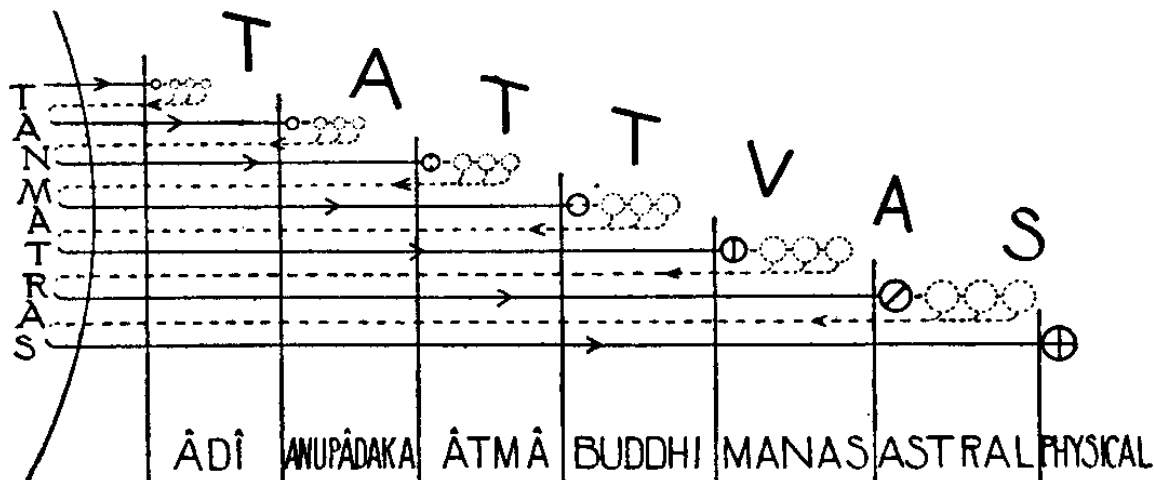

DIAGRAM XI.—Tattvas and Tanmātras.

It should be noted that, although the atoms of any one plane, the physical for example, are not made direct from the atoms of the plane immediately above - the astral - yet, unless the bubbles had had the experience of passing through all the planes above, physical atoms could not be made of them.

The Hindu method of describing the process is as follows: Each plane has what is called a, "tanmātra" (literally, a *measure of "that"*), and a, "tattva" (literally, "*thatness*" or "*inherent quality*"). The tanmātra is the *modification in the consciousness of the Logos*: the tattva is the *effect produced in matter by that modification*. We may compare the tanmātras with the waves of an incoming tide, which run up on a sandy shore, retire, and are followed by other waves, which run up a little further. The tattvas we may compare with the little ridges made on the sand by the incoming waves, at the furthest line that they reach. The idea is symbolised in Diagram XI.

Every atom thus has its "Thatness," the word, "That" being a reverent expression for the Divine Being. The measure of the vibration of the atom, imposed upon it by the Will of the Logos, is the Tanmātra, the "measure of That"; this is the axes of the atom, the angular divergence of which, within the fixed limits of vibration, determines its surface form.

Thus the consciousness of the Logos is within each atom, expressed within certain limitations, which we sometimes call "planes."

The process of the creation of matter in successive stages has often been described as the in-breathing and the out-breathing of the Deity.

The existence of matter depends absolutely upon the continuance of an idea in the mind of the Logos. If He chose to withdraw His force, for example, from the physical plane - to cease thinking it - every physical atom would instantly disintegrate, and the whole physical plane would disappear in an instant, like the light of a candle when it is blown out.

The ultimate physical atom has three movements of its own: (1) rotation on its own axis; (2) motion in a circular orbit; (3) a pulsation like a heart, a constant expansion and contraction. These three movements are always going on, and are unaffected by

any force from outside. A force from outside - a ray of light, for example - will set the atom as a whole moving violently up and down, the amplitude of this movement being proportional to the intensity of the light, and the wave-length resulting from the movement of a number of atoms being determined by the colour of the light.

Besides the force of the Logos, which holds the atom together in its form, one of His forces is playing through it at a number of different levels. There are seven orders of this force, one of which comes into operation during each round, working through what are called the spirillæ in the atom. For a description of these spirillæ, as well as other details of the structure of the atom, the student is referred to *Occult Chemistry* (1919 edition, pp. 21-23, and Appendix, ii-vi.) .

In interstellar space - between solar systems - the atoms are in the condition known as "free," lying far apart, and equidistant, this seeming to be their normal condition when undisturbed.

In the space between planets, however, they are never found free: even if they are not grouped in forms they are subject to a great deal of disturbance from cometic and meteoric matter, and also to considerable compression from what we describe as the attraction of the Sun.

From the above considerations, we perceive how it is that a man in, for example, his causal body, could move freely in the neighbourhood of a planet, where the atomic mental matter is in the compressed condition, but would not be able to move or function in far-away space, where the atoms remain free and uncompressed.

To continue with our description of the building of the solar system, we have now arrived at the stage where the vast whirling sphere contains within itself seven types of atomic matter, all one essentially, because all are built out of the same kind of bubbles, but differing in their degree of density. All these types are freely intermingled, so that specimens of each type would be found in a small portion of the sphere taken at random in any part of it, with, however, a general tendency of the heavier atoms to gravitate more and more towards the centre.

The Logos next sends out, still from His Third Aspect, a seventh impulse which, instead of drawing the physical atoms back into Himself and dissociating them into the original bubbles, draws them together into certain aggregations, thus making a number of different kinds of what may be called proto-elements; these again are joined together into the various forms which are known to science as chemical elements.

The making of these extends over a long period of ages, and they are made in a certain definite order, by the interaction of several forces, as is correctly indicated in Sir William Crookes' paper on *The Genesis of the Elements*.

The process of their making is even now not concluded: uranium is the latest and heaviest element, so far as we know, but others still more complicated may perhaps be produced in the future.

As the ages roll on, condensation increases, and presently the stage of a vast glowing nebula, usually of incandescent hydrogen, is reached. Various other systems in our universe are,

of course, now passing through this stage, as may be seen by means of any large telescope.

In our own case, as the mass cooled, still rapidly rotating, it contracted and flattened until eventually it became rather a huge revolving disc than a sphere. Presently fissures appeared in this disc, and it broke into rings, presenting somewhat the appearance of the planet Saturn and its surroundings, though on a far larger scale.

As the time drew near when the planets would be required for the purposes of evolution, the Logos set up at a chosen point in the thickness of each ring a subsidiary vortex, into which a great deal of the matter of the ring was gradually collected.

The collisions of the gathered fragments caused a revival of the heat, the matter being reduced to a gaseous condition, forming a glowing ball which, as it cooled once more, gradually condensed into a physical planet fit to be the theatre of life such as ours. Thus were all the planets of our system formed.

In this particular part of our system, however, the physical planet which was formed was, not the Earth, but the Moon. For a reference to Diagram V will show that the first physical planet appears in the third chain, and that planet, in our Scheme of Evolution, was the Moon.

When the active life of the Moon, in the third chain, was over, a new vortex was set up, not far away from the Moon, and the rest of the matter of the ring was gradually gathered into it. The resultant collisions once more produced a ball of glowing gas, which enfolded the body of the Moon, and very soon reduced it to a similar condition.

As this combined mass gradually cooled, condensation took place round the two vortices, but by far the greater portion of the matter was attracted to the new vortex, which became the Earth, leaving the Moon a much smaller body than it had been, and altogether denuded of air and water.

The Moon was still, from the intense heat, in a plastic condition, like hot mud, and the Earth in its earlier stages was subject to the most tremendous volcanic convulsions. In the course of these, enormous masses of rock, often many miles in diameter, were thrown up into space, to vast distances in all directions.

The majority fell back on the Earth, but some of them struck the Moon while still in its plastic condition, and produced upon it many of those huge depressions, which we now call lunar craters. Some, but not many, of the lunar craters are, however, really volcanic craters.

The Moon is at present like a vast cinder, hard but porous, of a consistency not unlike that of pumice-stone, though harder. Scarcely any physical action of any sort is now taking place upon its surface. It is probably slowly disintegrating, and it seems that in the course of our seventh round it will break up altogether, and its matter will be used (with, presumably, some of that of the Earth) to build a new world, which will be the only physical globe of the fifth chain of our Scheme of Evolution (*vide* Diagram V). To that new globe whatever remains of the Earth will act as a satellite, just as the Moon now Serves the Earth.

In Theosophical literature, the Moon has often been described as the eighth sphere, because it is not one of the

seven planets of our chain upon which evolution is taking place. It is therefore a "dead end," a place where only refuse gathers. It is a kind of dust-heap to the system, a kind of astral cesspool, into which are thrown decaying fragments of various sorts, such as the lost personality which has torn itself away from the ego (*vide The Causal Body*, p. 183).

CHAPTER VII

THE SOLAR LOGOS AND THE PLANETARY LOGOI

WE have mentioned, in the preceding chapters, the Solar Logos. It will now be fitting to consider Him, in His relation to the solar system, and also His principal Ministers, Who are often called the Planetary Logoi, though a more accurate name is the Planetary Chain Logoi.

In the Logos of our solar system we have as near an approach to a personal - it would be better to say an *individual* - God as any reasonable man can desire - For of Him is true everything good that has ever been predicated of a personal deity. Such attributes as partiality, injustice, jealousy, anger, cruelty, etc., we can, of course, set aside once and for all as being impossible for any deity worthy of the name, and as belonging merely to human imaginings. So far as His system is concerned, He possesses omniscience, omnipresence, and omnipotence. The love, the power, the wisdom, the glory, all are there in fullest measure.

Yet He is a mighty Individual - a trinity in unity, and God in very truth, though removed by we know not how many stages from the Absolute, the Unknowable, before which even solar systems are but as specks of cosmic dust.

It is probable that we cannot image Him at all; hence many devout people prefer not even to try to make any image of Him, but simply to contemplate Him as pervading all things, so that we ourselves are also He, all other men are He, and in truth there is nothing but God.

The Sun is His chief manifestation on the physical plane, and that may help us a little to realise some of His qualities, and to see how everything comes from Him. It may be regarded as the lens through which His power shines forth.

We may note here that every fixed star is also a sun like our own, each one being a partial expression of a Logos.

The physical Sun may be considered as a sort of chakram or force-centre in Him, corresponding to the heart of man, the outer manifestation of the principal centre in His body.

Although the whole solar system is His physical body, yet His activities outside of it are enormously greater than those within it. This solar system, which seems so stupendous to us, is to Him but a little thing; for, though He is all this, yet outside it and above it all He exists in a glory and a splendour of which we know nothing as yet. Thus, though we can agree with the pantheist that all is God, we yet go very much further than he does, because we realise that He has a far greater existence above and beyond His universe. "Having pervaded this whole universe with one fragment of Myself, I remain" (*Bhagavad Gita*, X, 42).

He thus exists far above His system: upon it He sits as on a lotus throne. He is, as it were, the apotheosis of humanity, yet infinitely greater than humanity. We might think of the Augoeides

(vide *The Causal Body*, p. 101) carried up higher and higher, and to infinity. Whether that form is permanent, or whether it can be seen at a certain level only - who shall say ?

Hence the rationale of the well-known symbol of the "Great Bird," which is used to denote the Deity in the act of hovering over His universe, brooding over the waters of space, or darting onward along the line of His evolution. To repose between the wings of the Great Bird means so to meditate as to realise union with the Logos: and it is said that the man who reaches that level may rest there for untold years.

It is probably beyond the power of words to express the method of union of humanity with Him. We human beings may, in one sense, be as cells in His body, but we are certainly very much more than that For His life and power are manifested through us in a way out of all proportion to that which would be a parallel relationship at a lower level, viz., that of the cells in our own physical bodies to ourselves as spiritual entities.

In His manifestation on the lowest cosmic plane, we may take it that His First Aspect is on the highest level - that of Ādi - the Second on the Anupādaka or Monadic plane, and the Third in the higher part of the Ātmic plane.

Hence, as an Adept, in the course of his development, gradually raises His consciousness plane by plane, he comes first to the Third Aspect, and realises his unity with that, moving on only after long intervals to full union with the Second and the First Aspects.

In the Ancient Mysteries of Greece, the Logos was symbolised by the child Bacchus, who was represented as playing with certain toys. One of these was dice, consisting of the five platonic solids. These are:

The Tetrahedron, bounded by 4 equilateral triangles;
 The Cube, bounded by 6 squares;
 The Octahedron, bounded by 8 equilateral triangles;
 The Dodecahedron, bounded by 12 regular pentagons;
 The Icosahedron, bounded by 20 equilateral triangles.

Adding to these at one end the point, and at the other end the sphere, we have a set of 7 figures, which correspond to the 7 planes of our solar system. Each of them indicates, not the *form* of the atoms of the different planes, but the *lines* along which works the power which surrounds those atoms.

This throws some light on the well-known saying of Plato that "God geometrises." It seems that the ancients studied the geometry of Euclid, not as we do, for itself, but as a guide to something higher.

Another of the toys of Bacchus was the top, a symbol of the whirling atom.

A third toy was a ball, representing the Earth, that particular globe of the chain to which the thought of the Logos is specially directed at the present time.

A fourth toy was a mirror, which has always been a symbol of the astral light, in which the archetypal ideas (of which we shall speak later) are reflected and then materialised.

Whilst the child Bacchus - the Logos - plays with his toys, he is seized by the Titans and torn to pieces. Later these pieces

are put together and built into a whole. This allegory of course represents the descending of the One to become the many, and the reunion of the many in the One, through suffering and sacrifice.

The Hindus have, of course, long held that the Deity plays, and they have called the great work of evolution the Lîlâ, or play of Shrî Krishna.

The whole of our solar system is a manifestation of its Logos, and every particle in it is definitely part of His vehicles. All the physical matter of the solar system taken as a totality constitutes His physical body; all the astral matter within it constitutes His astral body; all the mental matter, His mental body, and so on. From the Solar Logos comes forth all life in the successive Outpourings (*vide The Causal Body*, pp. 13, 14, 70). The First Outpouring comes from His Third Aspect, giving to previously existing atoms the power to aggregate themselves into the chemical elements the action described in the Christian scriptures as the Spirit of God moving over the waters of space.

When, at a later stage, the kingdoms of nature are definitely established, there comes the Second Outpouring, from His Second Aspect, which forms group-souls for minerals, plants and animals, this being the descent into matter of the Christ principle, which alone renders possible our very existence. In the human kingdom, the ego himself is a manifestation of the Third Outpouring, which comes from His First Aspect, the eternal and all-loving Father.

Before the solar system was brought into manifestation, the Logos formed the entire scheme of it in His mind, and by doing so brought it all simultaneously into existence upon His mental plane. He has thus thought it out, not only as it is now, but as it has been at every moment in the past, and as it will be at every moment in the future.

At what level His mental plane may be we cannot tell; it may be what we call the cosmic mental plane, or it may be higher still. The cosmic mental plane is two whole sets of planes above our set of seven.

To the cosmic mental plane H. P. Blavatsky gave the name the "archetypal world"; the Greeks seem to have called it the "intelligible world." All that has been written and said about an "instantaneous" creation of the whole system out of nothing refers to this formation of cosmic thought-forms.

Thus we may say that on that cosmic plane the whole of the System was called into existence simultaneously by His thought - an act of special creation; and it must all be now simultaneously present to Him. It may well be that His mighty consciousness to some extent reflects itself even on very much lower levels, so that men may occasionally catch faint glimpses of those reflections. This is one explanation of clairvoyants being sometimes able to foresee the future accurately, as unquestionably has been done, from time to time.

The Logos thinks out what He intends each of the Planetary Chains to do. He comes down to smaller, details, for He thinks of the type of man for every Root-Race and sub-race, from the beginning of all, through, for example, the Lemurian, the Atlantean, the Âryan and the succeeding Races. We shall deal later with certain of the Officials - if we may employ that term - Who are in charge of, directing and controlling the evolution

taking place in the solar system: but we may mention here that there is in charge of each scheme of evolution an Entity known as a Planetary Logos: a more accurate name is a Planetary Chain Logos, for He is in charge of the whole series of 7 chains in a scheme of evolution.

These 7 subsidiary Logoi are great individual entities: and yet at the same time they are aspects of the Solar Logos, force-centres, or chakrams, as it were, in His body.

Their relation to Him is like that of the ganglia or the nerve-centres to the brain. All evolution which comes forth from Him comes through one or other of Them.

Each of these centres has His special location or major focus within the body of the Sun, and also a minor focus which is always exterior to the Sun. The position of this minor focus is always indicated by a physical planet. Diagram XII is an attempt to illustrate the idea.

The exact relation, however, can hardly be made clear in our three dimensional phraseology. But we may say that each centre has a field of influence practically co-extensive with the solar system. If a section of this field were taken, it would be found to be elliptical: one of the foci of each ellipse would always be in the Sun, and the other would be the special planet ruled by that subsidiary Logos.

All the physical planets are included within that portion of the system which is common to all the ovoids, so that each revolving ovoid must have its projecting segment. Hence the system as a whole has been compared with a flower with many petals.

There is, however, another reason for this comparison with a lotus. Although the planets appear to us as separate globes, there is in reality a connection between them in a manner of which some idea may perhaps be gained by those who have trained themselves to a conception of four dimensions of space.

An analogy may be of some assistance. If the hand be held, with the palm upwards, so as to form a kind of cup, but with the fingers separated, and then a sheet of paper be laid on the tips of the fingers, the circles at the points of contact between the fingers and the paper would represent the physical planets, apparently quite isolated from one another.

These circles are, however, all connected together in another direction, as parts of the hand, although the idea of the

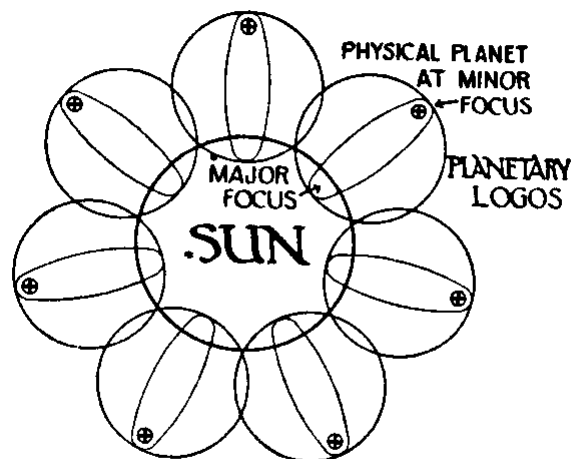

DIAGRAM XII.—Relation of Physical Planets to the Sun.

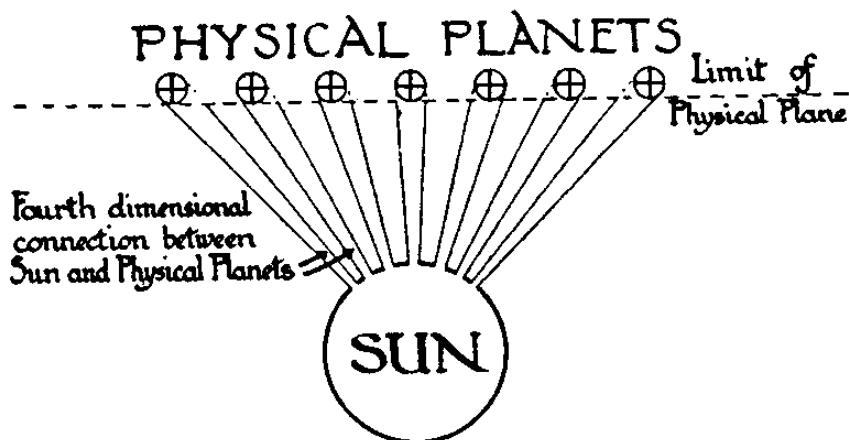

DIAGRAM XIII.—Fourth Dimensional Connection between Sun and Planets.

hand would be quite beyond the comprehension of a two-dimensional being living only in the plane of the circles.

Similarly, in a higher dimension, all the physical planets are connected together into one whole, being from this higher point of view but the points of petals which are part of one great flower. The heart of that flower throws up a central pistil which appears to us as the physical sun.

Diagram XIII is an attempt to portray the idea.

Normally, neither the physical, astral nor mental planes of one of our planets communicate with the corresponding planes of another planet. On the buddhic plane, however, there is a condition common to, at any rate, all the planets of our chain.

Notwithstanding the above, there is a condition of the atomic matter of each of the planes which is cosmic in extent, the 7 atomic sub-planes of our system, taken apart from the rest, constituting one cosmic plane - the lowest, sometimes called the cosmic-prakritic.

From one point of view it seems as though we were in truth an expression of the Planetary Logos Himself, and as though the evolution were taking place within His body, the globes being centres in that body, or rather, not the globes that we see, but the spirit of them—their higher principles.

From this point of view Globe A would be the expression of His brain or mental body, and all these forms would exist in His mind. For our mental plane is not only the third sub-division of the lowest cosmic plane; it is also at the same time the lowest sub-division of an aspect or manifestation of the Logos.

We may take it that He manifests Himself along seven lines or through seven aspects, and that each of these that we call planes is the lowest form of one of these aspects, so that the atomic part of our mental plane is really the lowest sub-division of the mental body of the Planetary Logos.

The willow-leaves of the Sun are manifestations upon the physical plane maintained by Devas for a special purpose, at the cost of a certain sacrifice or limitation of their activities on the higher levels which are their normal habitat. Recollecting that it is through the willow-leaves that the light, heat and vitality of the Sun come to us, we may readily see that the

object of their sacrifice is to bring down to the physical plane certain forces which would otherwise remain unmanifested, and that these great Devas are acting as channels, reflectors, or specialisers of divine power working at cosmic levels for the benefit of our solar system.

CHAPTER VIII

THE LIFE-STREAMS

WE have now completed the first portion of our study, on the field of evolution, having outlined the planes and places in which the evolution of life takes place. We may perhaps liken this to a description of the buildings of a university, with its colleges, lecture-halls and class-rooms. Our next step will be to study the streams of life which pour into the vast and complex structure of our solar system, just as streams or "batches" of students pour into a university, passing through various courses of study, eventually obtaining their degrees, and passing out into the world, there to fulfil such functions as their tastes and qualifications permit. Instead of a university, however, it would be more appropriate to use the illustration of a vast educational establishment, comprising every degree of education, from the nurseries and kindergarten of infants, to the most advanced honours course of a university.

We shall commence with the larger units, the vast streams or waves of life, and trace them through the various kingdoms of nature, subdividing as they go, until eventually we reach the races and sub-races of humanity, and individual men in those races, who climb steadily through the higher levels of the human kingdom until they pass into the superhuman levels of attainment.

In modern Theosophical literature the term "life-waves" has been employed in three distinct senses:

First. To represent the three great Outpourings (as they are more usually and perhaps more appropriately called) of Divine Life, from the three Persons of the Trinity, by means of which the solar system came into existence, and by which it is nourished and sustained.

Second. To describe the successive impulsions, or streams of life, of which the Second Outpouring is formed. It is these with which we are dealing in this chapter, and which we shall usually denote, for the sake of clarity, as *streams of life*, or *life-streams*.

Third. To signify the transference of life from one planet of a chain to another planet, in the course of the various "rounds." This we shall deal with in detail at a later stage of our study, when it will be seen that this kind of life-wave differs considerably from what we have called a life-stream.

Confining ourselves to our human line of evolution - ignoring for the moment the deva line of evolution, and other lines which may exist, but of which we know as yet little or nothing - we note that there are seven main kingdoms of life evolving side by side through our earth Scheme. Whether the same method is followed in the other nine Schemes or not, we do not at present know for certain, though there appear to be indications that this is probably substantially the case.

The seven kingdoms are:

The First Elemental Kingdom.

The Second Elemental Kingdom.
 The Third Elemental Kingdom.
 The Mineral Kingdom.
 The Vegetable Kingdom.
 The Animal Kingdom.
 The Human Kingdom.

All seven of these kingdoms are manifestations or expressions of the same life, the one life of the Logos, manifesting in that Second great Outpouring, which comes from the Second Aspect of the Trinity, after the primitive matter has been prepared for its reception by the action of the First Outpouring, which comes from the Third Aspect of the Trinity. (For fuller explanation of the Three Outpourings, and their work, *vide The Causal Body*, pp. 13, 14, 70).

The Second Outpouring comes forth in a series of successive waves, following one another like waves of the sea. It is the history of the progress of these waves of life - which we have decided to call *Life-streams* - that will be traced in this and subsequent chapters. The first three of the seven kingdoms are on the downward arc of evolution, i.e., the life in them is plunging deeper and deeper into matter. The First Elemental Kingdom, in fact, does not descend below the higher mental plane; the Second Elemental Kingdom does not descend below the lower mental plane; and the Third Elemental Kingdom comes down only as far as the astral plane.

The Mineral Kingdom represents the turning point, where the life reaches the lowest point of its descent into matter, and commences to ascend again through the planes. This phenomenon of descent into materiality and re-ascent into spirituality is one which constantly recurs in many ways, and will be dealt with more fully later on.

The Vegetable, Animal and Human Kingdoms are definitely occupied in rising steadily through the planes.

We may therefore arrange the kingdoms thus:

The Second Outpouring (from the Second Logos) consists, as

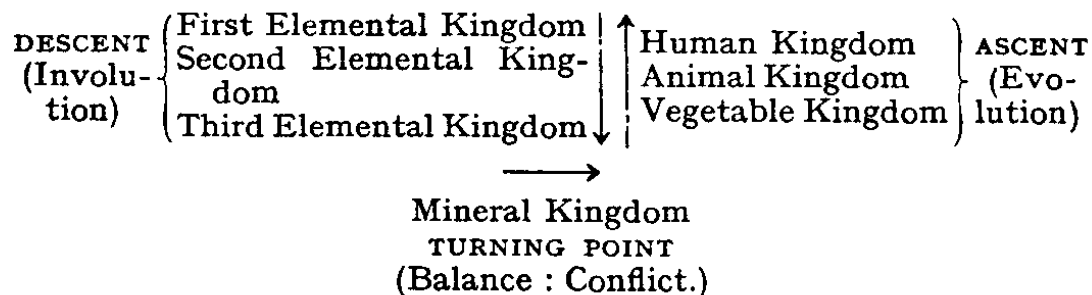

said above, of streams of life; in our line of evolution there are seven of these streams, composed of the seven kingdoms enumerated, and these are poured into the first chain of our Scheme.

The general plan is that each stream shall animate a kingdom for a whole chain-period, passing on into the next higher kingdom in the next chain, i.e., it takes a whole chain-period for any given kingdom to evolve to such a point that it becomes fit to pass into the kingdom succeeding it in the scale of progress.

That, as said, is the general principle: but there is an important modification with which we shall deal presently. It is omitted now, with so much else, in order to avoid introducing complications at too early a stage of our study.

From this it will be seen that, as the First Elemental Kingdom passes on into the Second Elemental Kingdom, there would be a gap caused in the position vacated by the kingdom which had passed on. This gap is filled by an entirely fresh life-stream, which pours forth from the Logos, and thus makes a new First Elemental Kingdom.

As this must take place in each of the seven chains, we perceive that there are altogether thirteen life-streams in our Scheme. These consist of the seven streams—one for each kingdom — which entered the first chain, and six entirely new streams, one of which entered each of the succeeding six chains, in order to provide, as explained, a new First Elemental Kingdom.

The progress of the kingdoms through the seven chains of our Scheme is illustrated in Diagram XIV.

The student is asked kindly to note the system adopted to indicate the various kingdoms, as it is one which will be followed in a number of subsequent diagrams. The First Elemental Kingdom is shown by one vertical line; the Second Elemental Kingdom by two vertical lines; the Third Elemental Kingdom by one inclined line; the Mineral by crossed vertical and horizontal lines; the Vegetable by inclined lines making a V. the Animal by an A; the Human by an H. It will be noticed that these indications have some relationship to the markings adopted for the matter of the planes, which makes them easier to remember.

The student will notice also that throughout the diagrams, whilst globes and rounds are indicated by circles, kingdoms of life and groups of entities are indicated by squares or rectangles.

From Diagram XIV it will be seen that the life which is now being expressed in our present humanity came up through the Animal Kingdom in the third (Moon) chain, through the Vegetable Kingdom in the second chain, and through the Mineral Kingdom in the first chain. Now, as each kingdom must pass through all the kingdoms that precede it, it is clear that the life-stream, out of which our present humanity has emerged, must have passed through the three Elemental Kingdoms in some previous chains, in some previous Scheme.

A similar consideration of course applies to all but the lowest life-stream which entered our first chain, *i.e.*, they must have passed through previous chains in some previous Scheme. Of such previous chains and Schemes we have no direct knowledge as yet, though we can clearly deduce the fact that they must have existed.

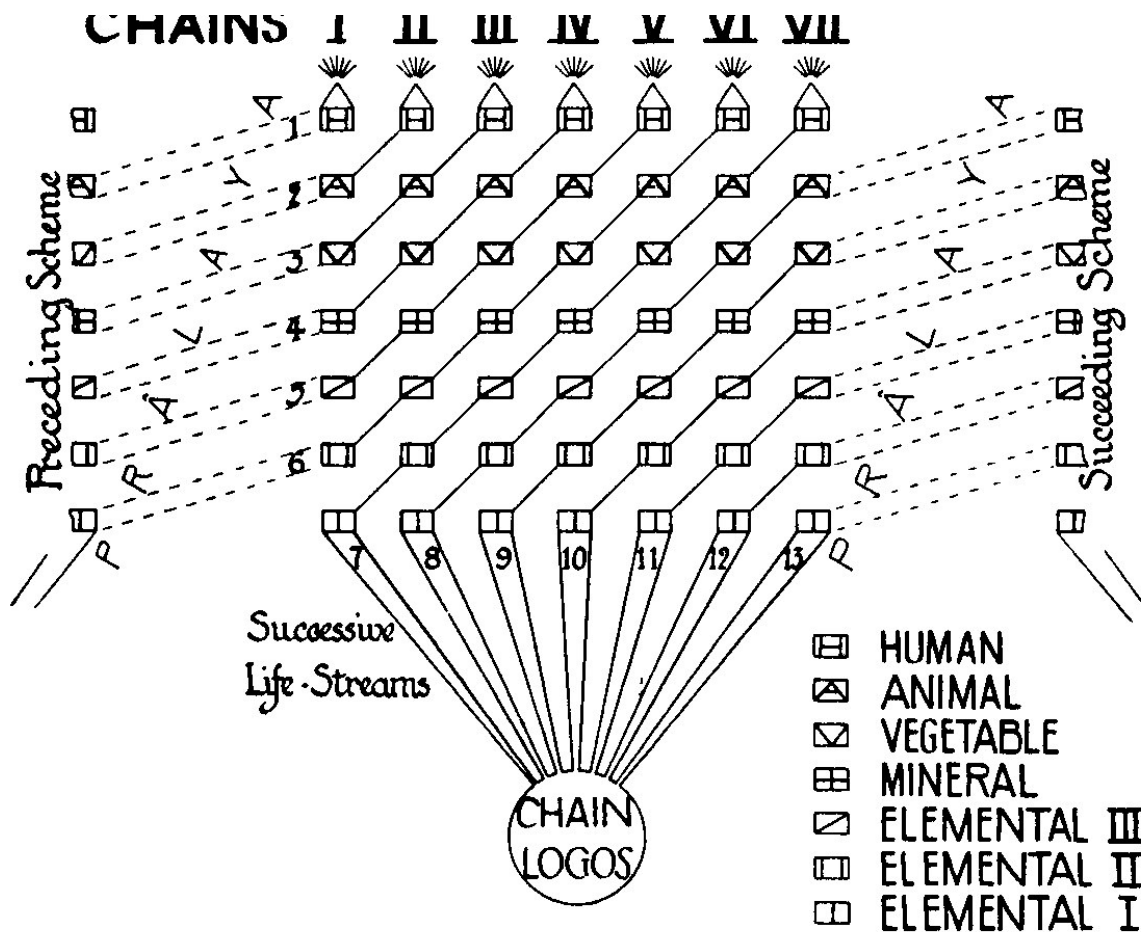

DIAGRAM XIV.—The Thirteen Life-Streams and their Progress.

Diagram XV is an attempt to illustrate the progress of the life-streams through successive Schemes.

The meaning of the seven radiating lines in Diagrams XIV and XV, at the head of the Human Kingdom, is that human entities pass out of the Human Kingdom into the superhuman, along one of seven possible paths of future progress. The full explanation of this we must once more postpone till a little later.

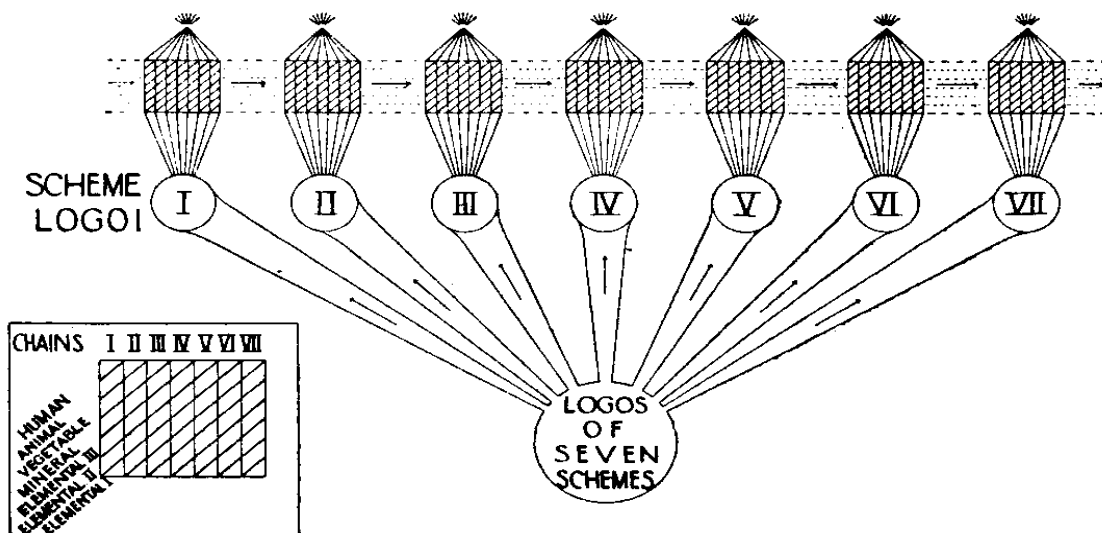

DIAGRAM XV.—The Life-Streams of Successive Schemes.

If we look at Diagram XIV we perceive that the only life-

stream which runs through the whole seven kingdoms in our Scheme of seven chains is that which entered the first chain as the First Elemental Kingdom (No. 7 in the Diagram). Climbing steadily, one kingdom in each chain, this life-stream eventually reaches the Human Kingdom, and passes out of it, in the seventh and last chain of our Scheme.

The other six kingdoms of the first chain, as already said, must have commenced their evolution in earlier chains, whilst the six life-streams which emerge from the Logos and enter the six chains after the first will have to continue and complete their evolution in chains subsequent to the seventh and last chain of our Scheme.

These considerations impress upon us the fact that, whilst our Scheme of Evolution is a complete and more or less self-contained field of evolution, having a definite beginning and a definite ending, yet it forms one in a larger series of successive Schemes. From this we may deduce that even the solar system as a whole follows the general principle which we find operating elsewhere in so many other directions, and is but one incarnation in some gigantic series. Anything in the nature of ultimate finality seems therefore—as we might have expected—to be utterly beyond the furthest horizon to which we can stretch our imaginations.

We have seen that the life-streams evolve through the various chains, passing through the whole of the seven globes in each round. Now it is very difficult for us to grasp with our physical consciousness what can be the condition of the life of the lower kingdoms on the higher planes; the idea of the evolution of a mineral, for example, on the mental plane, suggests nothing readily comprehensible to the ordinary mind. It would correspond to our thought of a mineral. Yet we should not assume that such a thought-form as we could make of a mineral would be its only representation on that level. The thought-form which exists there is that of the Manu, moulded by a power altogether beyond comparison with that of our mentality.

It may also help us to an understanding if we recollect that every mineral has its astral and mental counterparts, and it must be on these higher correspondences of the minerals that are produced certain effects which constitute their evolution.

Further, the special types of matter which form the counterparts are also on their respective planes manifestations of the mineral monad, and we may suppose that through such manifestations that monad is evolving during its existence on these loftier levels.

The essential fact to bear in mind seems to be that the whole process is the bringing down of the mind-energies flowing from the Logos - from His cosmic mental plane to that prakritic mental which is our mental plane. It is His idea of a mineral, materialised as far down as our thought of the etheric body of a mineral.

The Group-Soul also must always contain within itself latent possibilities connected with the higher planes through which it has descended; and it may be that in those stages of evolution these potentialities are being developed by some method quite outside those with which we are familiar.

Without the unfolding of psychic faculties we cannot expect

to understand in detail the hidden growth in these exalted spheres of finer matter; the important point is that we should realise that the life-streams are evolving in some way during the periods spent on all the globes, useful progress being made in every part of the chain.

It has already been mentioned that, besides the line of evolution which we are pursuing, there are also other lines which may be considered as running parallel with our own. For the divine life is pressing upwards through several streams, of which ours is but one, and numerically by no means the most important. We should bear in mind that physical humanity occupies only a small part of the surface of the earth, whilst entities at a corresponding level on other lines of evolution not only crowd the earth far more thickly than man, but at the same time populate the enormous plains of the sea and the fields of the air. The table of the evolution of life, appended here, shows the streams as flowing side by side as far as the mineral kingdom, but as soon as the upward arc is begun, they diverge. The streams re-unite at the Solar Spirits level.

The table must not be considered as in any way exhaustive, as there are no doubt other lines which have not yet been observed, and there are also certainly all kinds of variations and possibilities of crossing at different levels from one line to another. The table is designed merely to give a broad outline of the scheme.

THE EVOLUTION OF LIFE

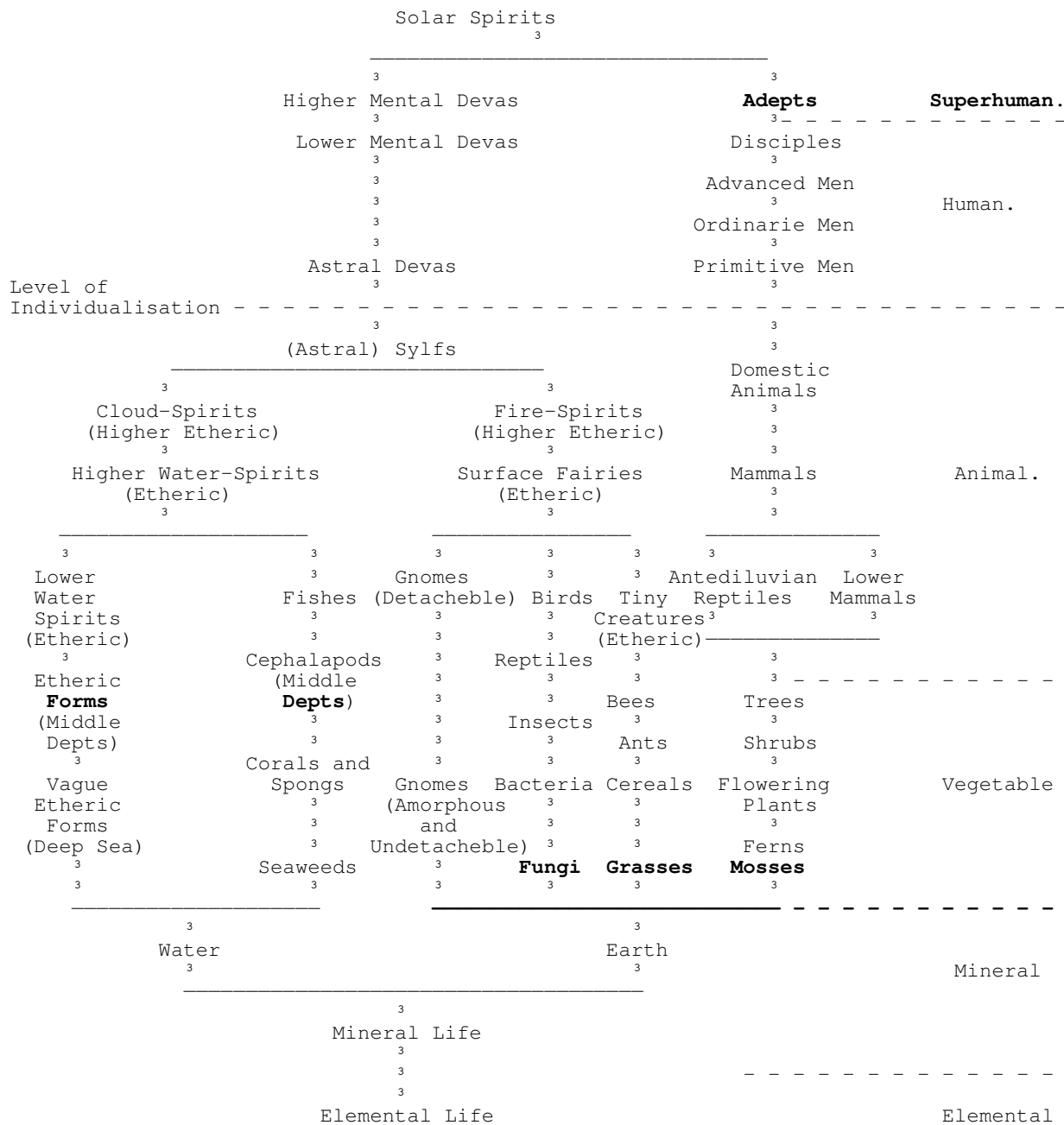

CHAPTER IX

THE GOALS OF OUR SEVEN CHAINS

WE have already seen that each life-stream climbs steadily up the kingdoms, at the average rate of one kingdom in each chain, until it reaches the human kingdom. Continuing to evolve through the human kingdom, it eventually rises out of ordinary humanity, as we know it, enters the super-human kingdom, and passes along one or other of seven possible paths of future progress and service. We shall enumerate and describe these seven possible paths presently.

But the stage at which human entities emerge from the ordinary human evolution, and enter the superhuman kingdom, varies considerably, according to the chain in which the emergence takes place. Thus the level reached by the most advanced humanity in the fourth chain is a great deal higher than that attained in the first chain: the level that will be reached in the seventh chain will be a still higher one.

There is, in fact, what may be called a "goal" set for humanity in each chain. This goal we may compare with the passing-out examination at an educational establishment. But, to complete the analogy, we must conceive of a certain class of students who pass out of the university after, say, only one year of tuition. They have reached a certain standard of education and, as the world needs all grades of workers, they may be considered qualified to perform certain grades of tasks in the outer world.

At the end of the second year of tuition, another group of students passes out: they will obviously have been able to reach a standard higher than that attained by the first-year students, and consequently will be qualified to fill posts of greater responsibility in the outer world.

Similarly, after three years at the university, a third group of students passes out, again at a higher level, having qualified themselves for posts of still greater responsibility, and needing more knowledge and experience. The process may be considered as continuing for seven years, until the seventh batch of students passes out, having attained a very high level and having learnt, perhaps, practically all that the university can teach them.

The university is then closed for a long vacation: or perhaps it would be more accurate to say that it is broken up, the buildings demolished, and the teaching staff dispersed. Such students who have not passed out of the university will resume their education in some future university, with a fresh staff of instructors, and an entirely new set of buildings. Returning from this analogy to our own seven chains in our Scheme, the goals, or qualifying "passing-out" examinations, are as follows:

- For the First Chain . The First Initiation.
- For the Second Chain . The Third Initiation.
- For the Third Chain . The Fourth Initiation (that of the Arhat).
- For the Fourth Chain . The Fifth Initiation (that of the

Asekha Adept).

No definite information is available regarding the goals set for the fifth, sixth and seventh chains. We may, however, indulge in a few cautious speculations. It is well known that, whilst in the very early stages of evolution, progress is almost inconceivably slow, as we measure time, yet in the later stages it becomes almost equally incredibly swift. The Master Kûthhûmi has stated that "when once a person enters upon the Path, *if he converges all his energies upon it* [we have ventured to italicise this qualification], his progress will be neither by arithmetical nor geometrical progression, but by powers."

That is to say, it would not be in the ratio 2, 4, 6, 8, etc. (arithmetical progression), nor in the ratio 2, 4, 8, 16, etc. (geometrical progression), but in the ratio 2, 4, 10, 256, 65,536, 4,294,907,296, etc. Thus a rate of progress expressed by 2, becomes, four stages later, one expressed by a figure exceeding 4,000 millions. With such vast figures does nature achieve her immense purposes.

We may therefore legitimately assume that the progress made in the fifth, sixth and seventh chains will be enormously greater than that achieved in the first four chains. That this must be so is clear from the fact that the level of Arhat, reached at the end of the third chain, may be considered as halfway to that of the Adept, reached at the end of the fourth chain. Thus the fourth chain seems to afford as much progress as the three first chains.

It is stated in *The Secret Doctrine* (I, 228) that the Perfected Men of the Seventh Round of our chain will be "but one remove from the Root-Race of their Hierarchy, the highest on Earth and our Terrestrial Chain." That is to say, the perfected men of our humanity, after three-and-a-half more rounds of evolution, will arrive one stage below that at which now stands the "Lord of the World," an Entity who will be described in Chapter XIX.

There are, moreover, a number of considerations which indicate a very high level of attainment for humanity at the end of our seventh chain. Thus, for example, even the buddhic consciousness gives a man his first touch of unity with the Logos. The Asekha Adept strives to raise the consciousness of His Monad into the consciousness of the Logos. The Monads are projected from the Logos in order that they may eventually return to Him as great and glorious suns, each capable of giving life and light to a magnificent system, through which and by means of which millions of other Monads may in turn develop. Each Monad has come, into manifestation through one of the Planetary Chain Logoi, and will eventually become part of a Heavenly Man, these Heaven-born Men being the true inhabitants of the solar system, the mind-born sons of the Planetary Logoi, destined themselves to be the Planetary Logoi of the future. We may therefore surmise that, at the end of the seventh chain, when our Scheme of Evolution is completed, the level we shall have reached will be, shall we say, something commensurate with that of a Planetary Logos.

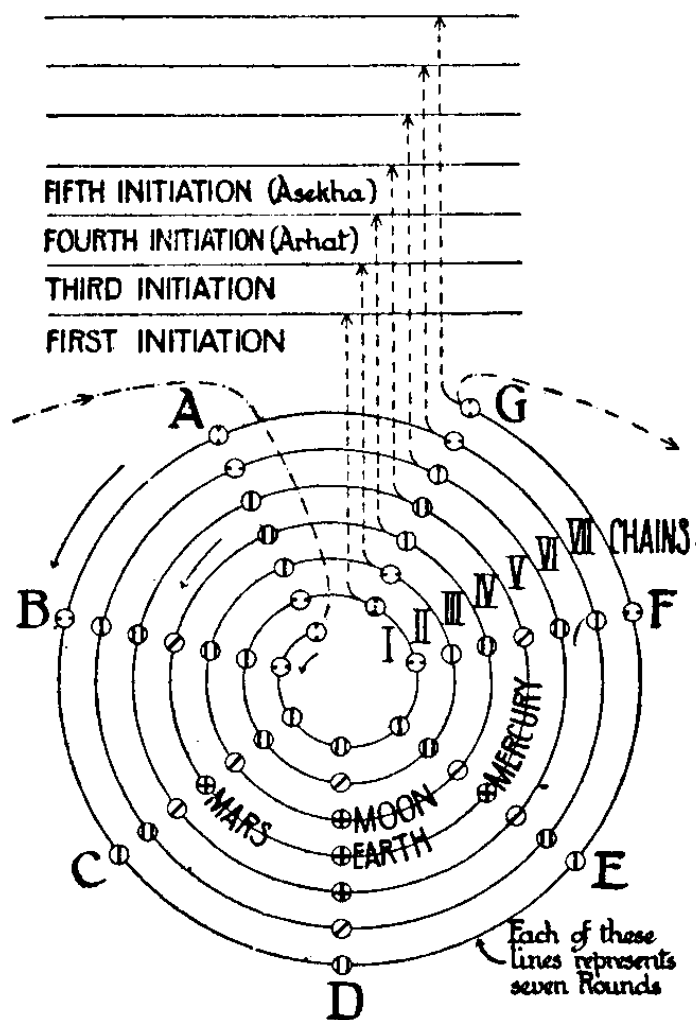

DIAGRAM XVI.—The Goals of our Seven Chains.

Diagram XVI may perhaps assist the student to memorise the goals set for our chains. In the diagram, the seven chains are arranged concentrically, the first being the innermost, the seventh the outermost. The wave of life which passes round the chains enters the first chain, and may be conceived as swinging round the globes and then, much as a stone is propelled when released from a whirling sling, projecting the most advanced humanity up to a certain level, viz., that of the First Initiation.

The remainder of the life-wave enters the second chain, swings round its globes and, in so doing, this being on a larger circle in the diagram, attains a higher velocity, precisely as would happen to a stone when whirled in a larger circle, this higher velocity enabling it to project its most advanced humanity to a higher level, viz., that of the Third Initiation. Similarly with each of the succeeding chains, the velocity of evolution becoming greater and greater as the circles become larger, until the seventh circuit is able to project its most advanced members to a very high, but as yet unknown, level.

We have just seen that when an entity has achieved the level

set for humanity in any given chain, he commences his superhuman evolution, and there open before him seven paths, of which he may choose one. The seven paths are as follows:

- (1) He may enter Nirvâna, to become perhaps in some future world an Avatâra, or divine Incarnation. This is sometimes called "taking the Dharmakâya vesture," the Dharmakâya keeping nothing below the Monad.
- (2) He may enter on the "Spiritual Period," a path which includes that of "taking the Sambhogakâya vesture"; he then retains his manifestation as a triple spirit and can probably show himself in a temporary Augoeides.
- (3) He may "take the Nirmânakâya vesture," retaining his causal body and all his permanent atoms.
- (4) He may remain a member of the Occult Hierarchy.
- (5) He may pass to the next chain, to help building its forms.
- (6) He may join the Deva evolution.
- (7) He may join the "Staff" of the Logos. For further details of these seven paths the student is referred to *The Causal Body*, p. 321.

CHAPTER X

DEGREES OF ATTAINMENT

Having now grasped the main outlines of the steady progress of the life-streams, rising at the average rate of one kingdom in each chain-period, we may now introduce the important modifying factor, which was mentioned in Chapter VIII.

Again we may employ the analogy of a batch of students at a university. It is a practically universal experience that, in every group of students, there will be a small minority who shoot ahead of the others, either because they have exceptional ability or because they apply themselves more whole-heartedly to their studies. This is the class that obtains "honours" degrees.

After them comes the main body of the students, who succeed in passing their examinations and who obtain an ordinary "degree."

After them again comes another minority—the "tail" of the class. These students either on account of their lesser abilities or through their lack of industry and application, fail to pass out and therefore will have to return to the university for another term, or portion of a term, in order to secure their degrees.

Precisely the same thing happens with each of the life-streams in each kingdom. There is always a small minority who run far in advance of the remainder and attain the "goal" before the appointed time. Next comes the great majority of the entities who fulfil the task set and attain the level required at the time appointed. After them again comes the "tail" another minority, though larger than the former minority, who fall behind, having failed to attain the level required.

Diagram XVII illustrates the process. Three kingdoms, A, B and C, are shown, and two periods, I and II. Of kingdom B, in period I, a tiny minority shoots ahead of the rest, reaches the goal set, and passes into kingdom A in the same period. The bulk of kingdom B passes into kingdom A in period II, in the normal routine manner.

The remainder of kingdom B, a minority larger than the former minority, fails to qualify for kingdom A and so continues in kingdom B in period II.

But, having already had some experience in kingdom B, whereas the remainder of kingdom B in period II, having only just come from kingdom C in period I, will be only I commencing its evolution in kingdom B, this laggard

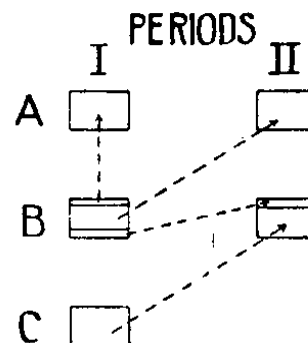

DIAGRAM XVII.—
Degrees of Attainment.

minority is able to take the lead in. period II. It is therefore shown in the diagram as entering kingdom B in period II at the head of that kingdom.

We may now reconstruct our diagram of the progress of the kingdoms, so as to show these complications in detail. Diagram XVIII is such a reconstruction. It may be explained as follows: Let us take, for example, the vegetable kingdom in chain I. The backward portion of this kingdom enters chain II, and there leads the evolution of the vegetable kingdom. The bulk of the vegetable kingdom from chain I passes into the animal kingdom in chain II. A tiny minority of the vegetable kingdom in chain I succeeds in attaining to the level of animals in chain I, and therefore joins the animal kingdom in chain I.

Following the progress of the main body of the animal kingdom of chain II, the process repeats itself. The laggard animals join the animal kingdom in chain III and lead that kingdom. The bulk becomes human in chain III; the small vanguard joins the human kingdom in chain II.

In chain III the laggard humans resume their human evolution in chain IV, where they lead the humanity of that chain. The bulk of the human entities attain their goal in chain III, and pass on to further fields of evolution and service, along one or other of the seven lines, as shown in the diagram by the ascending, diverging lines at the head of the kingdom.

Again a small minority succeeds in advance of the rest, and is shown in the diagram by the small spire rising from the centre of the kingdom. This group, of course, also has seven choices before it, as indicated by the seven radiating lines emerging from its head.

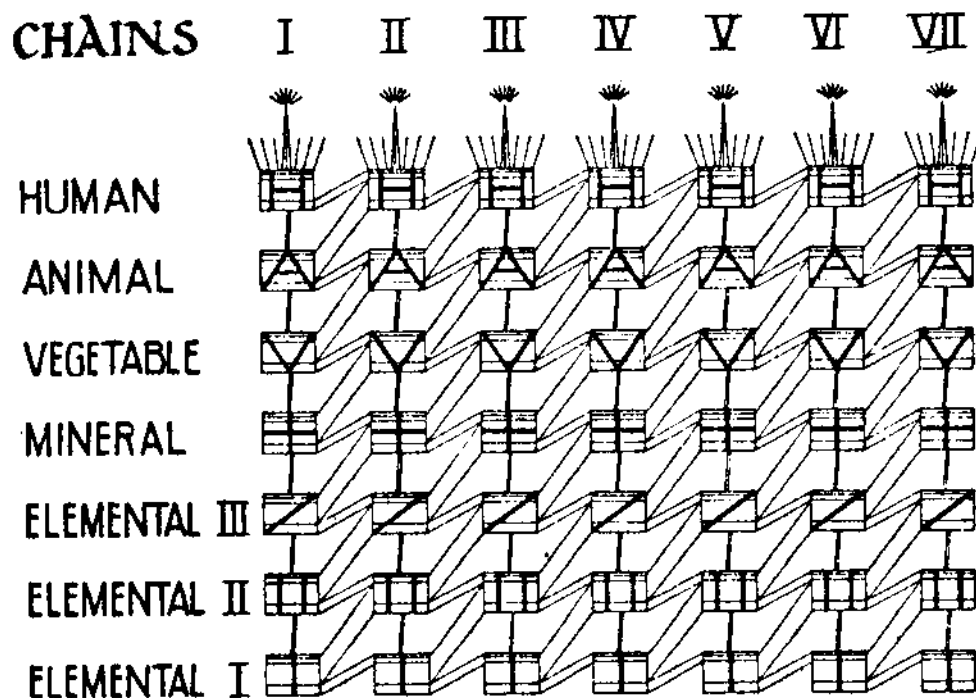

DIAGRAM XVIII.—The Progress of the Kingdoms.

In view of the fact, already stated, that the degrees of success attained by the members of each kingdom vary considerably, we should regard each of the life-streams as breaking up into smaller streamlets some of which join the preceding or succeeding streams, though the majority move steadily forward along the appointed course.

We may mention here an important principle, affecting the progress of the various streams of life and their innumerable sub-divisions, of which we shall find many particular examples in the later portions of our study. It is the general rule that those who have attained the highest possible in any chain, round, globe or race, are not born again into the *beginning* of the next chain, round, globe or race, respectively.

The earlier stages are always for the backward entities, the "youngest" and only when they have already passed through a good deal of evolution" and are beginning to approach the level of those who had done better, do those others descend into incarnation and join them once more.

That is to say, almost the earlier half of any period of evolution, whether it be a race, a globe, a round or a chain, seems to be devoted to bringing the backward people up to nearly the level of those who have got on better. Then these latter—who in the meantime have been resting in the mental world, in devachan—descend into incarnation along with the others, and they all then proceed together along their path of progress.

Thus, for example, as we shall see in detail later on, the most developed from the third or Moon Chain do not enter the

first round of the fourth or Earth Chain, but come in only in the middle of the fourth round. Also the egos who incarnate in the first Root-Race of a planet are those who have not progressed beyond the middle of the evolution of the preceding planet.

Using once more our analogy of students at a university, we may imagine that the more backward students return to their colleges, after their vacation, sooner than the more advanced students. They then have an opportunity of catching up approximately to the level of the more advanced students, who remain still on vacation. When they have done this, the more advanced students then return to their colleges, and all of them then resume their studies side by side.

The student should bear in mind this important principle because, as just said, he will presently find many examples of its workings, the rationale of which becomes perfectly clear when once the main principle is clearly grasped.

Further study of the degrees of attainment of the various kingdoms leads us to a consideration of a most interesting and important part of the general plan of evolution, viz., that of the "Days of Judgement." With this we shall deal in a separate chapter, but, as it involves references to the races of mankind, we will first explain the division of the human kingdom into these races and sub-races.

CHAPTER XI

RACES AND SUB-RACES

For the purposes of the general scheme of evolution, the human kingdom is divided into seven great races, usually called Root-Races, in each globe-period. But it would perhaps be more accurate to say that in each globe-period there are seven stages of growth of the human kingdom, these stages not always being so clearly marked or differentiated from one another as is the case at present, with our clearly-distinguishable races.

Each of these Root-Races, or stages of development, is divided into seven sub-races, or seven sub-stages; and again each sub-race is further divided into seven smaller units, variously known as branch-races, or nations.

In our present globe-period the seven Root-Races are as follows:

First Root-Race. This is called the Etheric Race, because it possessed no bodies denser than the etheric. No definite sub-races can be spoken of, though there are seven stages of growth or evolutionary changes. This race has long disappeared from the Earth.

Second Root-Race. This is the Hyperborean Race: it had physical bodies, and occupied a continent, called Plaksha, in the north of the globe. It also has now disappeared from the earth.

Third Root-Race. This, the Lemurian Race, occupied the continent of Lemuria, or Shalmali, as it is called in ancient story. Roughly speaking, this was a large Pacific continent in the South Sea. The race is the Negroid, and some of its descendants still exist, though by this time much mixed with offshoots of later races.

Fourth Root-Race. This, the Atlantean Race, inhabited the continent of Atlantis, or Kusha, most of which has now disappeared beneath the Atlantic Ocean. Most of the present inhabitants of the Earth to-day belong to this race.

Fifth Root-Race. This is the Âryan Race, and includes at present the most advanced members of the Earth's inhabitants. Krauncha is the name given to the present land surface of Europe, Asia, Africa, America and Australia.

Sixth Root-Race. This Race has not yet come into being, though it will shortly appear. It is destined to occupy a new continent, which has already begun to rise, fragment by fragment, in the Pacific.

Seventh Root-Race. This Race will follow the sixth, and will be the last to appear on the earth in this cycle or round. Nothing is as yet known of the continent it will inhabit, though the name Pushkara is sometimes given to it.

The names of the seven sub-races of the Fourth (Atlantean) Root-Race are as follows:

- (1) Rmoahal.
- (2) Tlavatli.

- (3) Toltec.
- (4) Turanian.
- (5) Semitic.
- (6) Akkadian.
- (7) Mongolian.

The sub-races of the Fifth Root-Race are as follows:

- (1) Hindu.
- (2) Aryo-Semitic.
- (3) Iranian.
- (4) Kettle.
- (5) Teutonic.
- (6) Only just commencing to arise in various parts of the world.
- (7) Not yet appeared.

In the latter part of this book we shall take up the study of these races and sub-races in some detail. For the present, however, we are concerned only to note the division of the human kingdom into these broad classes.

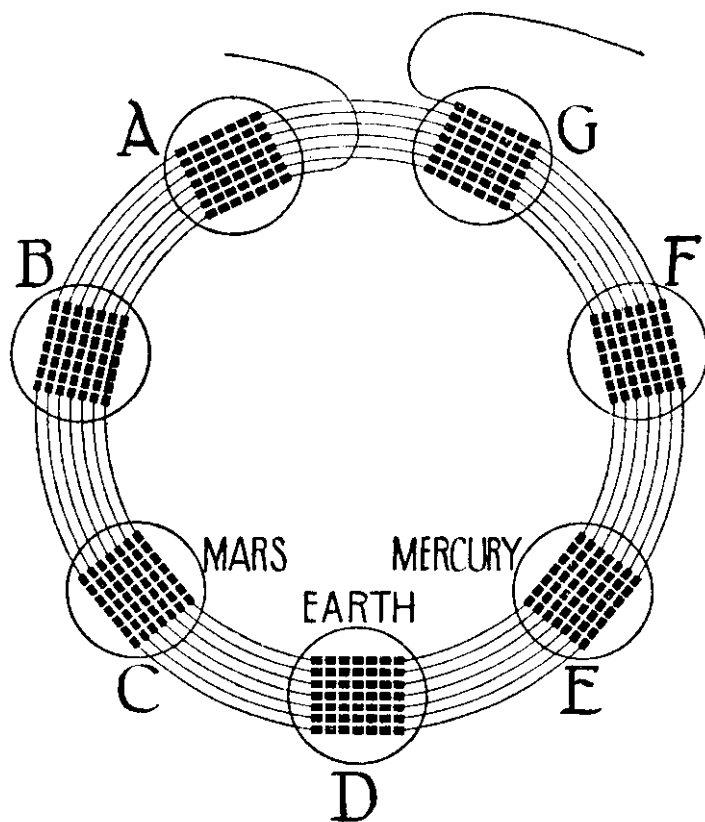

DIAGRAM XIX.—The Root-Races of the Earth Chain.

The Root-Races—or the stages corresponding to Root-Races—of our chain of globes are illustrated in Diagram XIX. There being seven Root-Races in each globe-period, there are 49 Root-Races in each round, and 343 Root-Races in the whole chain.

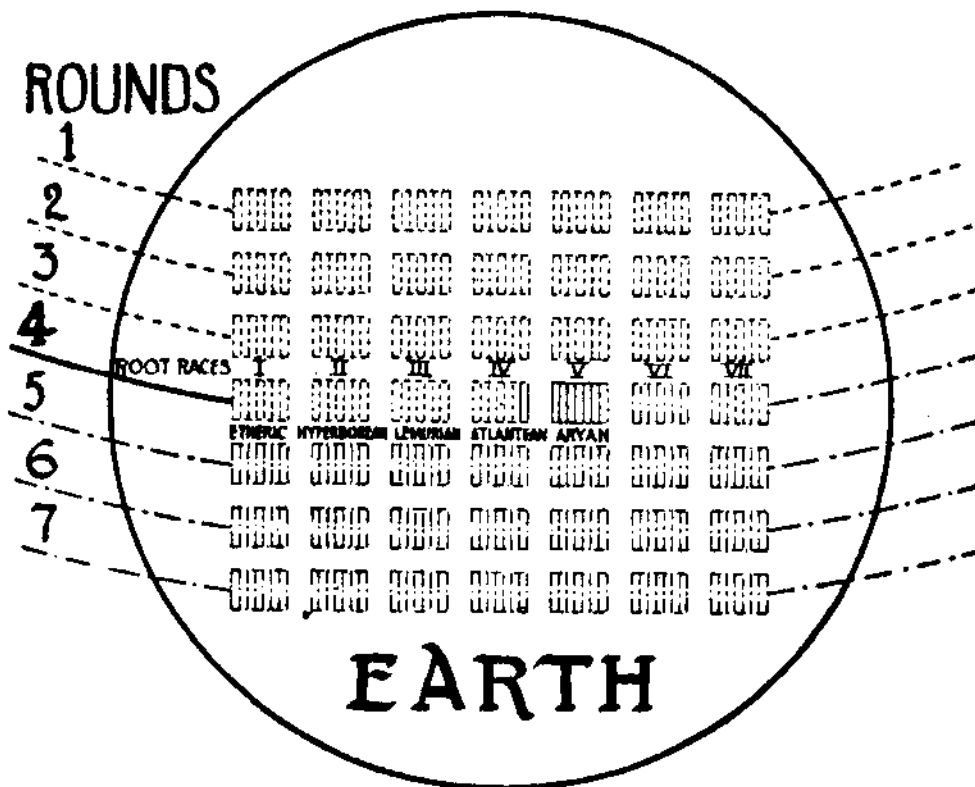

DIAGRAM XX.—The Races of the Seven Earth-Periods.

Diagram XX illustrates the earth, with its Root-Races and sub-races. Those which are past and gone are shown in dotted

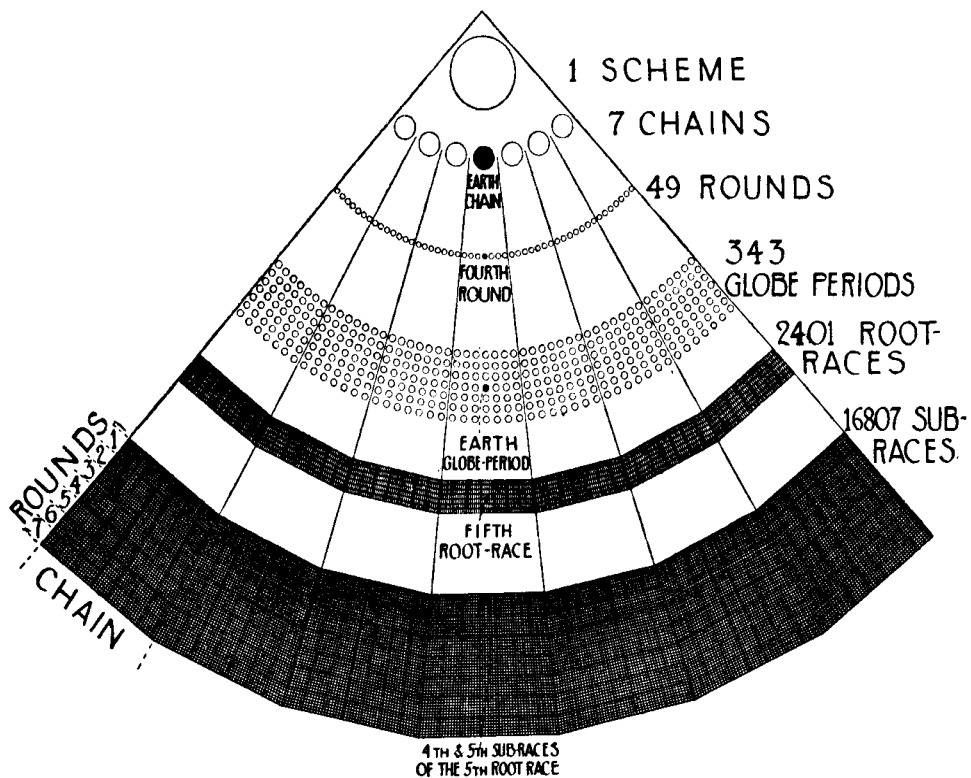

DIAGRAM XXI.—The Root-Races and Sub-Races of our Scheme of Evolution.

lines; those of which some descendants still exist are shown with continuous lines, their names also being marked; those Root-Races which have not yet come into being are again shown by dotted lines.

In order to give the student some perspective idea of the proportionate place held by Root-Races and sub-races in the whole vast scheme, Diagram XXI illustrates all the units, from chains down to sub-races.

Expressed numerically, the relationships are as follows:

7 Branch-Races or Nations	.	1 Sub-Race.
7 Sub-Races	. . .	1 Root-Race.
7 Root-Races	. . .	1 Globe-Period.
7 Globe-Periods.	. . .	1 Round.
7 Rounds	. . .	1 Chain.
7 Chains	. . .	1 Scheme of Evolution.
10 Schemes of Evolution	.	Our Solar System.

CHAPTER XII

THE INNER ROUND

IN Chapter II, which dealt with Rounds, we saw that each globe of a chain becomes in turn fully active; then it passes into a period of obscuration, whilst the next globe in order becomes fully active for a time. This process is repeated, each globe of the chain thus enjoying seven periods of full activity, with intervening periods of obscuration, or *prâlaya*.

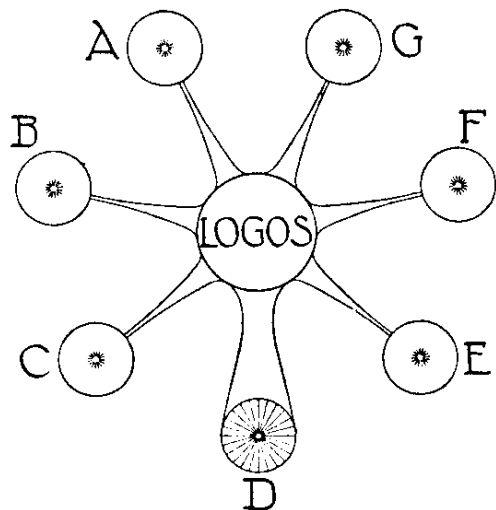

DIAGRAM XXII.—The Passage of the Life-Wave.

Another way of describing the phenomenon is to say that the Logos fixes His attention upon a given globe, where-upon the life there flames out, and evolution of the kingdoms pushes rapidly forward. When He withdraws His attention from the Life-Wave. Globe, the life fades away, the wheels of progress slacken, and the wave of life passes on to the globe to which His attention is next turned. But on none of the globes does the life ever die out altogether. The term Life-wave will be used for the transference of life from one globe to another.

Diagram XXII expresses the idea. The diagram shows one globe in the full blaze of the attention of the Logos, whilst the other six globes enjoy but a tiny beam of His Radiance, and are consequently in a condition of obscuration, partial but not complete.

The passing of the life-wave from one globe to another is a gradual process, and there is considerable overlapping.

Taking, as an example, our own chain at the present time, although the attention of the Logos is now fixed especially on our earth, which is consequently enjoying a period of maximum activity, there are yet representatives of all the kingdoms of life simultaneously existing upon every one of the six other globes of the chain. These representatives, or nuclei, serve at least three purposes:

I. They obviate the necessity of creating anew the forms for the kingdoms of life to occupy, during the next and succeeding periods of full activity. They thus furnish the seed, from which the forms will develop when the attention of the Logos is once more directed to the planet concerned, in the next round.

II. They serve as evolutionary fields for entities who are lagging somewhat behind their fellows.

III. They serve as forcing-houses for certain entities who are making unusually rapid progress.

We shall now explain these three functions.

It is obvious that, if representatives of the kingdoms were not left on each globe, a vast amount of labour and time would have to be expended, each time a globe came into full activity, in building up afresh the myriads of forms for occupation by the kingdoms of life. Such a course would be highly uneconomical, and is rendered unnecessary by the device of leaving a nucleus of each kingdom on each globe.

The nucleus of each kingdom remains small. It usually maintains its numbers at about the same level through the untold millions of years that elapse before that planet again becomes active. When its turn for full activity arrives, and a vast number of entities are ready to incarnate in it, the stagnant race suddenly becomes wondrously prolific; great changes and vast improvements of all kinds are quickly introduced, and vehicles are soon evolved fit to receive the coming inrush of entities far more highly evolved than those in the original nucleus.

Diagram XXIII illustrates the process. In this diagram, which represents our own chain, the original seven kingdoms on

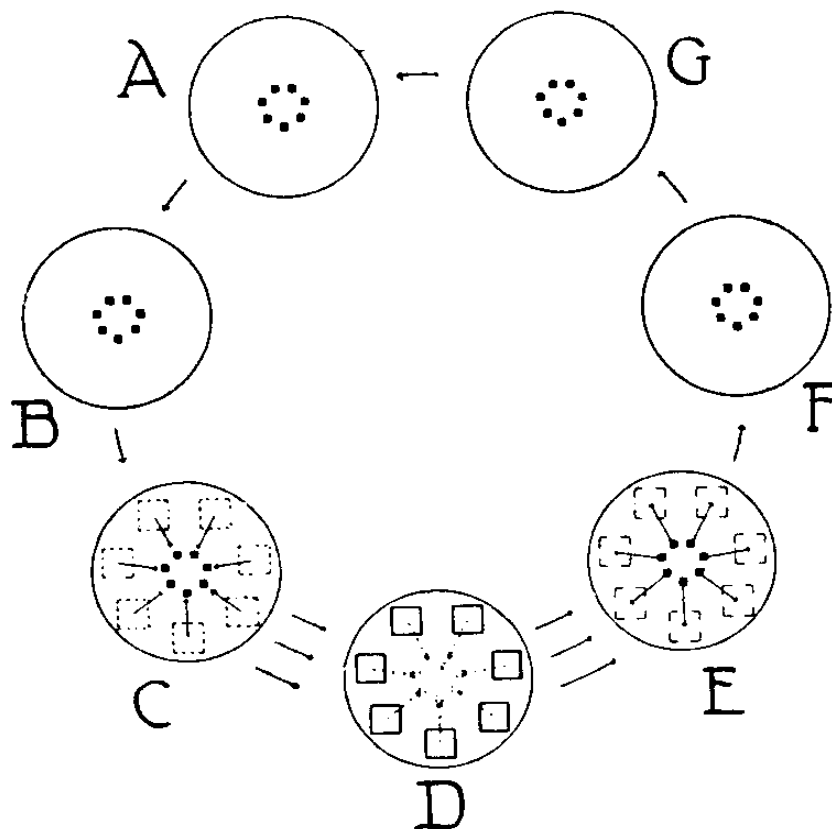

DIAGRAM XXIII.—The Nuclei on the Planets in the Inner Round.

Globe C (Mars) are shown dotted, indicating that they have disappeared except for a much shrunken nucleus, as represented by the small squares. The wave of life then passes on to the next globe, the Earth, where it becomes fully active, the kingdoms then reaching their maximum size.

When the time comes for the wave of life to leave the Earth, and pass on to Mercury, Globe E, the nuclei which exist there will become prolific, and expand until represented in the diagram by the arrows radiating outward from the nuclei to the larger squares, which represent the full-sized kingdoms.

We come now to the second function of the nuclei—the provision of a field of evolution for backward entities. Towards the end of every round there are always certain entities, in all the kingdoms, which do not achieve quite what was expected of them; consequently, when the evolution on Globe F is completed, they are not fit to go on to Globe G.

They are, accordingly, left behind, and continue to work on steadily among the remnant nucleus. They may, in process of time, make sufficient progress to join the remnant nucleus on Globe G. Possibly, also, by some extraordinary impulse, occasionally some may hurry on and overtake the wave of life out of which they have dropped.

More often, however, they will continue to lag behind, until they are overtaken by the wave of life on its next journey round the globes. In that case, they—we refer here of course to human

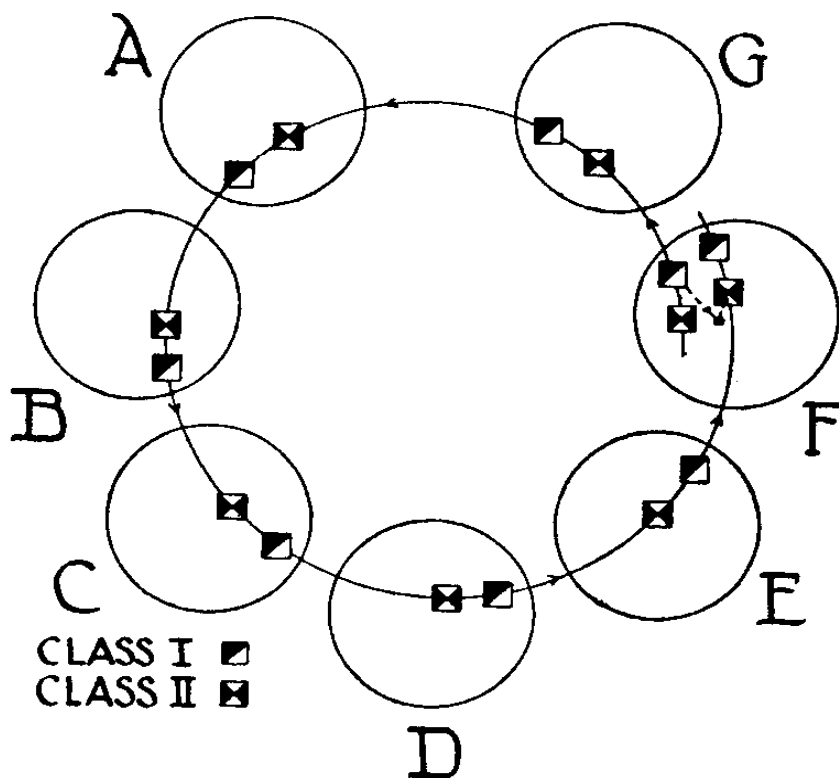

DIAGRAM XXIV.—The Inner Round : Retrogression.

entities—usually find themselves in a class of Monads lower than that to which they previously had belonged.

Such laggards thus fall behind the life-wave and, by losing one round, drop into an inferior class. As already said, a certain proportion of these laggards appear on every planet, and in all the various kingdoms, e.g., mineral essence that fails to

reach the vegetable kingdom, vegetable life that fails to reach the animal kingdom, animals that fail to become individualised as human beings.

Diagram XXIV illustrates the process. Two classes of entities are shown, the first halved, in the drawing, the second quartered. An entity drops behind from Class I, remaining with the small nucleus on Globe F. The remainder of Class I and Class II then pass through Globes G, A, B, C, D, E and back again to F, in the succeeding round. The entity, still in the nucleus of Globe F, then joins Class II on Globe F and continues his evolution with that class.

The third function of the nuclei—and this is the one which is usually spoken of as the function of the Inner Round proper—is the exact reverse of the above, and is to enable certain entities to make unusually rapid progress. Diagram XXV illustrates the process.

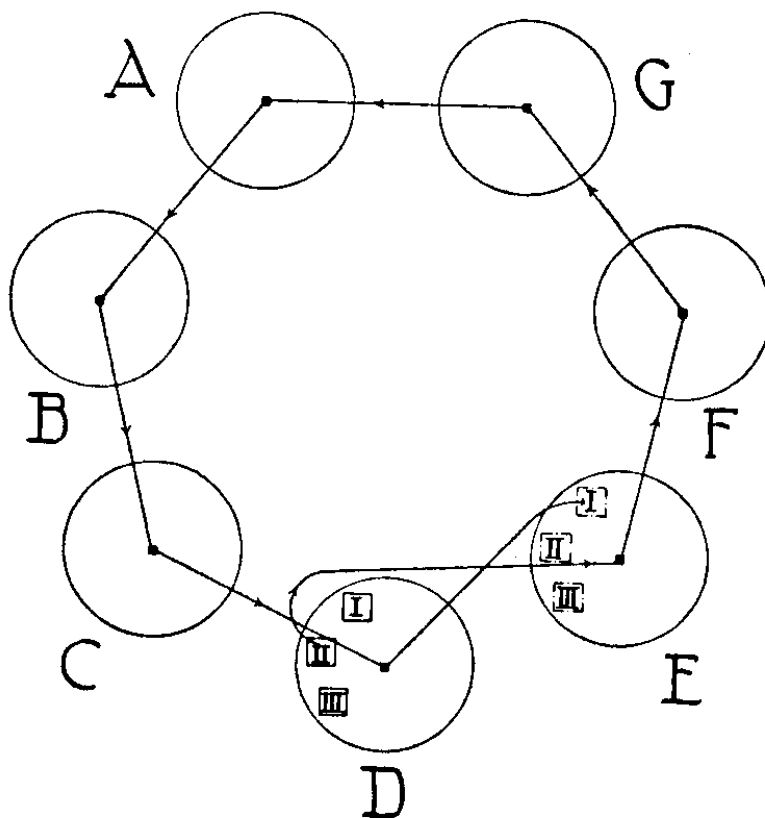

DIAGRAM XXV.—The Inner Round : Speeding up.

On Globe D, the Earth, are shown two classes of entities, Nos. I and II. Under certain conditions of strong desire for advancement, an entity of Class II, if he is seen to be striving with exceptional vigour to improve himself, may be separated from the great mass of his fellows on this planet, and passed by the Authorities into the Inner Round proper, taking his next incarnation, not on the Earth, but among the limited population on Mercury.

In that case he will spend there about the same time that he would otherwise have devoted to incarnations in one root-race on

the Earth, and will then pass on to the astral planet F. After a similar stay there, he will be transferred to Globes G, A and B, successively, and then to Mars and to the Earth.

In view of the fact that, on each globe, he will have made a stay about equivalent to the normal period of a Root-Race, the life-wave will have left the Earth by the time he works round to it again, and will have passed on to Mercury. Here he will rejoin it, but now as a member of Class I; and with that Class he will continue his future evolution. By thus racing round the whole series of seven planets of the chain, he has raised himself into a higher class of Monad.

Entities, engaged upon this special line of evolution, form the majority of the small population of Mercury and Mars at the present time. But in Mars there is also a certain residuum of primitive mankind, which was left behind when the life-wave passed from Mars to the Earth, being unfit to come to the Earth with the rest of their fellows. This race represents a stage of humanity lower than any at present existing, of which we have any knowledge. It will probably be extinct long before we reach Mars in the fifth round, since there appear to be no other egos needing manifestation at that level for the moment.

CHAPTER XIII

"JUDGEMENT DAYS"

THERE are many legends of a "last judgement," at which the future destiny of men will be decided. Behind these legends there lies an important occult truth, though unfortunately the diseased imagination of the mediæval monk distorted the perfectly simple and rational idea of æonian *suspension* into that of "everlasting damnation."

Our old analogy of a school may again be used to explain the rationale of the process. We may postulate a teacher of a class who, with a year's work before him, has to prepare his pupils for a certain examination. He makes his plans, so as to allot appropriate portions of the work to each term and month of the year. But, as the pupils are of various ages and capacities, some learn rapidly and make speedy progress, whilst others drag behind. Moreover, new students are constantly coming into the class, some of them only just up to its minimum standard.

About half way through the year the teacher, reviewing the position, decides to admit no more pupils to his class. This he does because, knowing what is required for the examination, he realises the impossibility of any pupil below a certain initial standard, making sufficient progress to enable him to pass the examination at the end of the year.

A little later in the year, the teacher again reviews the position of his pupils and foresees that, whilst some of his students will certainly pass the examination, the prospect of others is doubtful, whilst there are yet others who are certain to fail. He would then, with perfect reason, say to these last, the least advanced of his pupils:

"We have now reached a stage when the further work of this class is useless to you. You cannot possibly, by any effort, attain the necessary standard in time for the examination. The more advanced teaching, which must now be given to the others, would be entirely unsuitable for you, and, as you cannot understand it, you would not only be wasting your own time, but would also be a hindrance to the rest of the class. It will therefore be better for you at once to transfer yourselves to the class next below this, perfect yourselves there in the preliminary lessons, which you have not yet thoroughly learned, and come back to this level with next year's class, when you will be sure to pass with credit."

Here we have exact analogies of what has taken place, and will take place, in our earth chain. For, in the middle of the fourth round, save for a few exceptional cases, the "door was shut" for animals to enter the human kingdom, the reason being that, if they were allowed to enter, at this late stage of the chain, it would be impossible for them to continue evolving side by side with a humanity which would be so much in advance of them.

Next, in the middle of our next round, the fifth, will take place the great "separation," when human entities, who are not sufficiently advanced to progress with the rest, will be dropped out and pass into a condition of suspension, until a future chain

provides for them opportunities suitable for them to continue their evolution.

This section of the human kingdom may be described as "lost" to us, the remainder, because its members drop out of this particular little wave of evolution. In College phraseology, they will cease to be "men of our year." They will, however, become "men of the next year"-in fact, they will become leading men in it, because of the work they have already done" and the experience they have already had.

Most of these people fail because they are too young, although they are too old to remain in the class below-the animal kingdom. They have had the experience of going through the first portion of the chain, and will therefore be able in the next chain to take up their evolution readily and easily, and, moreover, will be able to help their more backward fellow-men who have not had their advantages. For such as these, who "fail," because they are too young, there is clearly no blame whatever.

There is, however, another large class, who might have succeeded by determined effort, but who fail for want of that effort. These correspond to pupils who fail, not because they are too young, but because they are too lazy to do their work. Their fate is the same as that of the others, but, while those were blameless because they did their best, these others are blameworthy precisely because they did *not* do their best. Hence they will carry with them a legacy of unpleasant karma, from which the former class will be free.

It is to men of the class who are not making sufficient effort that the exhortations of the Christ were particularly addressed, *i.e.*, men who had the opportunity and ability to succeed, but who were not making the necessary efforts.

It is of these, again, that H. P. Blavatsky spoke in such vigorous terms as "useless drones who refuse to become co-workers with Nature, and who perish by millions during the manvantaric life-cycle" (*The Secret Doctrine*, III, 526). We note, however, that this "perishing" is merely from this "manvantaric life-cycle," *i.e.*, from this chain, and that it means for them, not total extinction, but only delay.

Delay, in fact, is the worst that can happen to people in the ordinary course of evolution. Such delay is undoubtedly serious, but, bad though it be, it is the best that can be done under the circumstances. Such people are clearly in need of more training, and that training they must have, even though it may mean many lives-many of which may be dreary, and may even contain much suffering. But that is the only way in which they can attain to the level destined for them, and to which they certainly will attain in due course.

It was with the object of "saving" as many people as possible from that additional suffering that the Christ said to His disciples: "Go ye into all the world and preach the gospel to every creature; he that believeth and is baptised shall be saved, but he that believeth not shall be damned." For baptism, and its corresponding rites in other religions, is the sign of the dedication of the life to the service of the Brotherhood, and the man who grasps the truth, and consequently sets his face in the right direction, will certainly be among the "saved" or "safe," who escape the "condemnation" in the fifth round. The

"damnation," as we have seen, means merely rejection from this "æon" or chain of worlds, a throwing back into the next of the successive life-streams.

The "belief," referred to above, does not, of course, refer solely to men who accept Christianity or Theosophy. It does not matter in the least what their religion is, so long as they are aiming at the spiritual life, so long as they have definitely ranged themselves on the side of good as against evil, and are working unselfishly onward and upward.

The above problem may be approached from a numerical basis. It seems that it is just possible for even the lowest savage now living to reach, before the middle of the fifth round, the level necessary for continued evolution in this chain; but, in order to do so, he must never once fail to take advantage of each opportunity, as it is offered to him; and the number who will do this will be infinitesimally small.

It has been calculated that the proportion who will be prepared to continue in this chain will be about three-fifths of the total population of the present human kingdom, whilst the remaining two-fifths will be suspended.

The total number constituting the present human kingdom is estimated at some 60,000 million, this number of course including not merely the physical population but also those on the astral and other planes. Hence, approximately 36,000 million will go on with the chain, whilst 24,000 million will be suspended.

After this great "separation," the surroundings will be specially adapted for the rapid progress of the more advanced egos, and will therefore be wholly unsuitable for entities at a much lower stage of evolution, because the gross vibrations of violent passion, which are necessary for the development of the inert and half-formed astral body of the savage, will no longer be available. It is easy to imagine many ways in which this unsuitability will show itself. Thus, for example, in a world of high intellectual and spiritual development, where war and the slaughter of animals have long been things of the past, the existence of savage races, full of undisciplined passions and desire for conflict, would obviously intrude many serious difficulties and complications. And though, no doubt, means might be devised for their repression, that very repression would debar them from the activities requisite for their early stage of evolution.

Those entities who are left behind will, as said, take their place in the next chain. They will not on that account suffer in any way. They will merely have a very prolonged period of rest in such heaven-life as they may be capable of appreciating, and, no doubt, even though their consciousness during that period will probably be but partially awakened, a certain amount of inner progress will be going on.

From that condition, they will descend into the earlier stages of the evolution of the next chain, and will be among the leaders of primitive humanity there. The remainder of that humanity will, of course, consist of human entities created from what is now, on the earth, our animal kingdom.

Another important reason why the great fifth round "separation" is necessary, is that the later races of men will be in much closer touch with the Adepts and the great devas than

is now the case. It will therefore be necessary for them to hold themselves in an impressible condition, in readiness to receive and respond to an outpouring of influences. This, in its turn, requires that they shall live a peaceful and contemplative life, which would, of course, be an impossibility if there were still left in the world savage races who would attack and kill a man in a state of contemplation.

The more powerful vibrations of that time would not rouse the higher nature of the savage, but merely stimulate and intensify his lower passions, so that he would gain nothing by being on earth at that time, whilst he would make impossible the progress of the more developed people.

It must not be thought that the whole of the human entities, who succeed in passing the critical point in the fifth round, will attain the full goal set for this chain, viz., that of the Asekha, or Adept. On the contrary, it is estimated that only one-third of those who continue in the chain will become Adepts.

The other two-thirds will have to enter the next chain, the fifth, though not in its earlier stages; they will probably appear at about its middle point. For them, however, the matter will be complicated by the fact that the goal set for the fifth chain will be higher than that set for the fourth or present chain, *i.e.*, it will be some level higher than that of the Asekha Adept.

Whilst we are dealing with this point, it will be well to complete this portion of our study and describe what will probably be the actual distribution of human entities at the end of our chain. We can enumerate six well-defined classes, though obviously each of these might be further sub-divided.

I. Those who, following the steeper Path, attain Adeptship in rounds before the fifth.

II. Those who attain the goal set, and become Adepts in the seventh round. These are the vanguard of those who followed the usual path.

III. Those who attain the Arhat level in the seventh round.

IV. Those who are on the three lower levels of the Path Proper, *i.e.*, who have passed the First, Second or Third Initiations.

V. Those who "failed", at the critical point in the fifth round.

VI. The great body of the animal kingdom, who will arrive at individualisation into the human kingdom towards the end of the seventh round, and so will form the humanity of the fifth chain.

Of the total number of egos engaged in this evolution about 60,000 million—it is expected that about one-fifth will attain

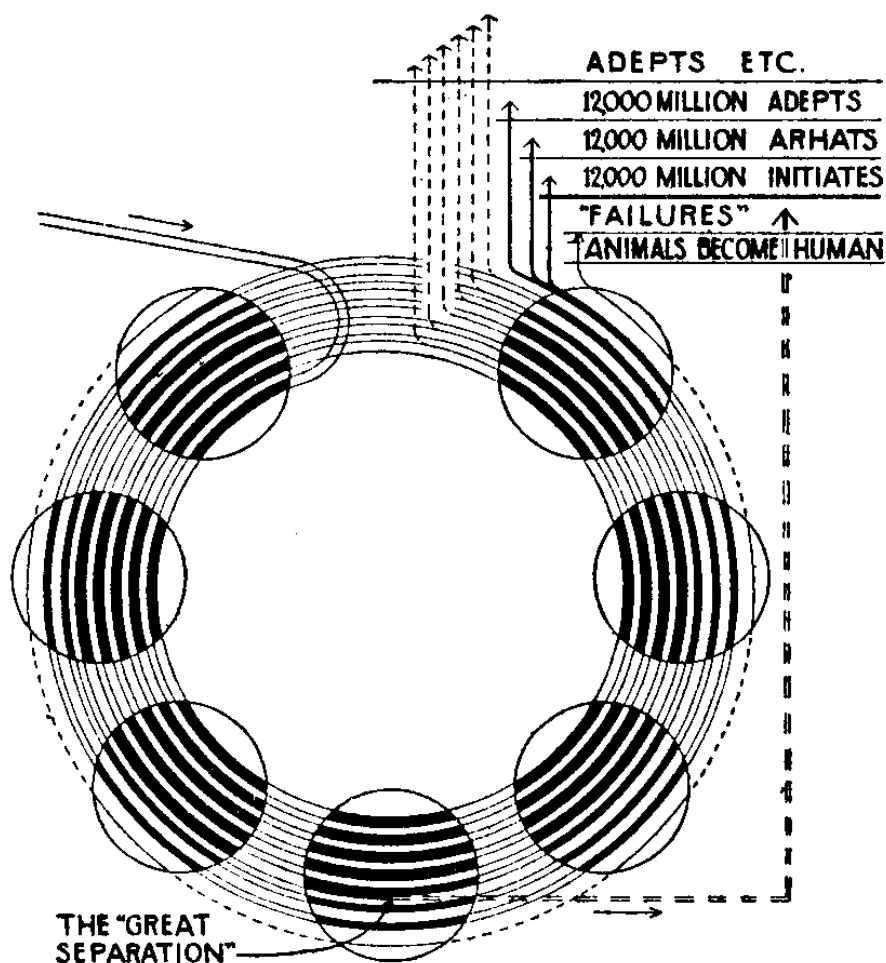

DIAGRAM XXVI.—Products of the Earth Chain.

the Asekha level before the end of the seventh round. Another fifth will by that time have gained the Arhat level; a third fifth will be on the lowest stages of the Path; the remaining two-fifths will have dropped out at the Great Separation in the middle of the fifth round.

Diagram XXVI illustrates both the great "separation" in the middle of the fifth round and also the distribution of human entities at the end of the chain.

In the diagram, those who attained Adeptship in rounds earlier than the seventh, are shown as reaching to some level higher than that of the Asekha Initiation, because, in all probability, they will have taken further Initiations by the time the chain is completed, and the diagram is intended to show the distribution at the *end* of the chain.

A similar phenomenon of a "Judgement Day," as was mentioned before, took place with regard to animals entering the human kingdom: this occurred in the middle of the fourth round of our present chain—the midmost point of our whole Scheme of Evolution, when the "door was shut," to use the commonly accepted phrase,

against the animal kingdom joining the human kingdom. After this "no more Monads can enter the human kingdom. The door is closed for this cycle" (*The Secret Doctrine*, I, 205). In this case, as in other Judgement Days, the statement must not be interpreted in too hard and fast a manner; for here and there an animal, by very special help, may still be evolved to a point where human incarnation is possible for it, but in almost all cases no human body can be found of sufficiently low development for its embodiment.

The door against further immigration into the human kingdom from the animal was shut only when no more were in sight, or would be capable of reaching it without a repetition of the tremendous impulse given only once in the evolution of the Scheme, at its midmost point. This tremendous impulse was given by the descent of the Lords of the Flame from Venus, and will be described in a later chapter.

An interesting point may be noted here. It seems as though the humanity of a chain can advance towards and enter the Path only when the individualising of animals on that chain has practically ceased, and when only exceptional cases of individualisation will occur in the future. When the door of the human kingdom is shut against animals, then the door to the Path is opened to humanity.

The great body of our present animal life-stream, as previously explained, will arrive at individualisation only towards the end of the seventh round of our present chain, and will therefore form the humanity of the next or fifth chain. But occasionally an animal, usually closely associated with humanity and specially developed in affection and intelligence, may be fortunate enough to attain individualisation in the present world-period. Such an animal may be accommodated with a primitive human body at the commencement of the occupation by our life-stream of the next planet-Mercury-in our present chain. It is obvious that very few indeed will be able to take advantage of this, which, so far as can be seen, will be the final opportunity of entering the human kingdom in the life of this chain.

A case is known where an animal, unusually intelligent and very devoted to his human friend, and also capable of travelling when asleep in his astral body to visit his master, could have been almost immediately incarnated in this world, were it not for certain difficulties which arose. The animal would have been, in many ways, a primitive savage, and yet could have been incarnated only in immediate personal relation to his master, for whom his attachment was so strong that it would have been impossible to keep him away from him. Even this difficulty might have been overcome, but for the fact that it was impossible to guarantee the sex of the savage.

The phrase as to "shutting the door" applies only to those animals who are coming up into the human kingdom in the present globe-period, and not to those whose causal bodies which, though primitive, are already formed. Thus the anthropoid apes, of whom H. P. Blavatsky spoke as still admissible to human bodies, belong to the animal kingdom of the Moon Chain, not to that of the Earth. They took up bodies produced by what is known as the "sin of the mindless" (which will be explained in a later chapter), and are the gorillas, chimpanzees, orang-outangs, baboons and

gibbons. They might be looked for in Africa, and might incarnate there in the still existing very low human races of the Lemurian type.

It seems probable that the principle underlying the "separation," i.e., the temporary suspension of entities unfit to advance side by side with the more advanced members of the same kingdom or life-stream, is applicable in many ways other than that already described.

In *The Theosophist* for July, August and September, 1916, Mr. G. E. Sutcliffe works out the idea with great lucidity and acumen, and in a most interesting manner. He points out that, in accordance with the rule, so widely applicable in occultism, the rule of correspondences, "as above, so below; as within, so without," there should be corresponding "Judgement Days" in each portion of the cycles and sub-cycles of our evolution.

Thus, as the separation in the middle of the fifth round rejects those unfit for the chain, there should be a separation of the Second Order in the middle of every fifth globe-period, rejecting those unfit for the remainder of the round; a separation of the Third Order, in the middle of every fifth Root-Race, suspending those unfit for the remainder of the globe-period; and a separation of the Fourth Order, in the middle of every fifth sub-race, rejecting those unfit for the remainder of the Root-Race.

Putting these conclusions to the test of observation, we know that the great catastrophe, which destroyed Atlantis in 75,025 B.C., must have occurred about the middle of the fifth sub-race of the fourth Root-Race, and was therefore a "Judgement Day" of the fourth order, rejecting those unfit to continue with the remainder of the fourth Root-Race.

Similarly, it is possible that the recent Great War (which, incidentally, some people think is not yet finished), and which affected mainly the fifth Root-Race, but only incidentally the fifth sub-race, is a "Judgement Day" of the third order, in which the unfit are suspended for the remainder of the globe-period. If this hypothesis be correct, then those unfit for the remainder of the globe-period will be deferred, and continue their evolution on Mars, thus joining the Inner Round in the reverse direction, as explained in a previous chapter.

This theory receives support from the following statement: ". . . some of the quite irredeemable people, who are participating in this great struggle [the War] will be thrown out and will pass into Avîchi, to wait there until some future planet is evolved, when they will again begin their evolution."

The magnitude of the crisis, of which the War was, if not the whole, certainly a part, is indicated by the following: "The War will become a swift and certain way of accomplishing in a few years the work of centuries, of ensuring an unexampled progress towards a nobler and better civilisation." Also: "I have recently laid much stress on our urgent duty to give to the Hierarchy the co-operation for which that Hierarchy is asking, it being the first time in the history of evolution that They can attain Their object, without destroying the whole civilisation as They did in Atlantis, and on a smaller scale in Rome" (Dr. Annie Besant).

It further appears that the conditions now obtaining on Mars (with which we shall deal more specifically in a later chapter)

are such as to be eminently suited to the evolution of those who, owing to their "scientific materialism," we may, without presumption" conceive to be unfit to continue side by side with the less materially-minded population of the earth during the remainder of the fifth Root-Race, and the coming sixth and seventh Root-Races.

Mr. Sutcliffe's theory is, as said, on the face of it eminently reasonable, and seems to be borne out by two facts of observed history. We may, therefore, adopt it, at least provisionally, and make some attempt to illustrate the method of its working in a diagram.

Let us first tabulate our data thus:

"DAYS OF JUDGEMENT" OR SEPARATIONS

Order	occurs in the middle of	rejecting those unfit for the remainder of	which entities will resume their evolution in
First	the fifth round	the chain	the next chain
Second	the fifth globe-period	the round	the next round
Third	the fifth root-race	the globe-period	the next globe-period
Fourth	the fifth sub-race	the root-race	the next root-race

In the diagrams which follow, Root-Races are shown as rectangles, and may be considered as composed of seven vertical strips, representing the sub-races. The effects of the four orders of Judgement Days are shown by removing pieces from the lower right-hand portions of the rectangles. Diagram XXVII shows the effect of a Judgement Day of the Fourth Order, rejecting those unfit to continue with the remainder of the Root-Race.

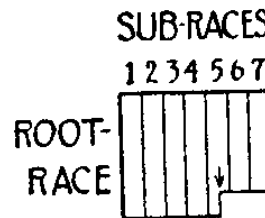

DIAGRAM XXVII.—
A Root - Race
Judgement Day
(Fourth Order).

Diagram XXVIII shows the effect of a Judgement Day of the Third Order, rejecting those unfit to continue through the remainder of the

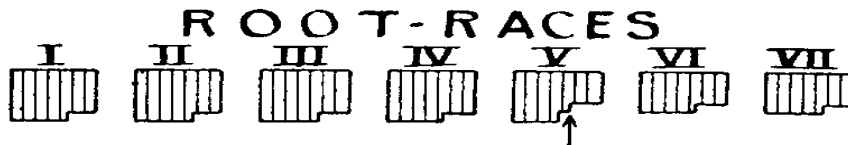

DIAGRAM XXVIII.—A Globe-Period Judgement Day
(Third Order).

globe-period. It will be observed that, from the middle of the fifth globe-period, the two Orders of Judgement Day are superimposed on one another.

Diagram XXIX shows the effect of a Judgement Day of the Second Order, when those are rejected who are unfitted for the remainder of the round. The drawing shows also the effects of the Judgement Days of the Fourth and Third Orders.



**DIAGRAM XXIX.—Judgement Days in one Round
(Fourth, Third and Second Orders).**

The effects of all four Orders of Judgement Days are shown in Diagram XXX.

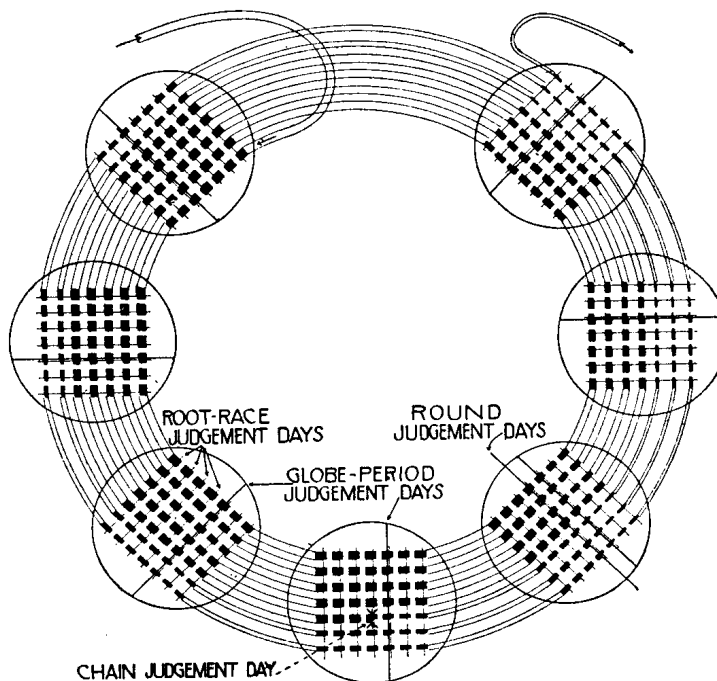

DIAGRAM XXX.—The 400 Judgement Days of our Chain.

The curious may note that the total number of Judgement Days, of the four Orders, in our whole chain, is exactly 400, all of which are shown on Diagram XXX.

The underlying idea of the whole process is that, in any given period, the number of entities who are fit to continue to the end of that period is appreciably reduced by successive applications of Judgement Days of four grades; hence the number of entities who are able to complete the whole chain is very substantially less than the number who entered the chain at its commencement. In the middle of the fifth round it is reduced from 100 per cent. to 60 per cent.; on top of this reduction there will be further reductions owing to the application of separations of the Second, Third and Fourth Orders.

The "Day of Judgement" of the Moon Chain is stated to have occurred in the sixth round, on the fourth globe—the Moon itself. According to our rule, this should have taken place in the fifth round. It may be, therefore, that our generalised rule is incorrect; or there may have been something exceptional in this case; or, possibly, the Judgement Day is a process which extends over a considerable period, and this may perhaps have been the final portion of it, occurring a whole round after its commencement.

However that may be, a whole race of savages were

exterminated by war, being incapable of advancing further on the Moon Chain, bodies suitable for their low state of evolution being no longer available. As they died, or were killed, they were not re-born, but passed into a condition of sleep. Many bodies of similar low types were annihilated by seismic catastrophes which laid whole districts waste, and the population of the globe was very much diminished. From that time forward all. was directed to pressing forward as rapidly as possible those who remained, preparing them for evolution on the next chain-the Earth Chain; the hopeless "laggards," having been dropped, growth thereafter was steady and more rapid than before.

The suggestion that the Day of Judgement for a chain is a process extending over a considerable period seems to be supported by the statement that, in the seventh round of the Moon Chain, from each globe, those of the inhabitants for whom the conditions of the subsequent globes were not suitable, dropped out, remaining quiescent until the next chain was ready for them to resume their evolution.

Another apparent exception to the general rule is that, in the first chain, no failures were seen dropping out of its evolution. If it had a Day of Judgement, investigation did not observe it. There is, however, another explanation, which some students may consider preferable. The following table sets out this theory without need of further explanation:

Number of chain	3 3 3	Judgement Day (First Order)
I	3	Nil (a)
II	3	Round 7
III	3	Round 6
IV	3	Round 5 (a)
V	3	Round 4 (a)
VI	3	Round 3
VII	3	Round 2
	3	

The three items marked (a) are known to be in accordance with facts, and it therefore may well be that this theory, for which I am grateful to an ingenious friend, is the correct one. If it is correct, then, whilst the main principle remains the same, substantial modifications would be needed in Diagram XXX, to make it accurate.

CHAPTER XIV

INVOLUTION AND EVOLUTION

THROUGHOUT every phase of our System there is a fundamental principle, which is repeated over and over again, at many different levels. This principle should be clearly grasped, because it is the Ariadne clue to the whole labyrinth. It comprises the seven great stages of Involution and Evolution. During three stages the Spirit descends into Matter: the Life is involved in Form; the fourth stage is that of conflict between Spirit and Matter, between Life and Form; during the three remaining stages the Spirit ascends: Life evolves through and out of Form.

During its descent, Spirit may be conceived as brooding over Matter, imparting qualities, giving to Matter powers and attributes. The fourth stage stands alone; Matter, having received or acquired various powers and attributes, comes into manifold relations with the informing Spirit. This is the great battle of the universe, the tremendous conflict between Spirit and Matter, the battle of Kurukshetra, of the vast hosts of the two opposing armies, as Hindu scriptures describe the process.

In this part of the Field is the point of balance. The Spirit, coming into innumerable relations with Matter, is at first overpowered; then comes the point of balance, when neither has the advantage over the other. Then slowly the Spirit begins to triumph over Matter, so that, at the end of the fourth stage, Spirit is the master of Matter, and is ready for the ascent through the three stages that complete the seven.

During the last three stages, the Spirit organises the Matter which he has mastered and ensouled, and turns it to his own purposes, shapes it for his own expression, so that Matter may become the means whereby all the powers of the Spirit shall be made manifest and active, being shaped into the perfect vehicle which the Spirit needs in order to manifest himself perfectly.

During the descent of Spirit, often called the down-ward arc, there is not only a tendency towards greater materiality,

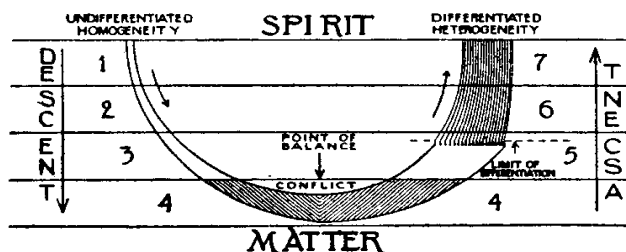

DIAGRAM XXXI.—The Downward and Upward Arcs.

the Spirit involving itself in Matter in order to learn to

receive impressions through it, but there is also a tendency towards differentiation, the stream of Divine Life dividing and sub-dividing itself into an ever-increasing number of streamlets and units of consciousness.

During the earlier part of the ascent of Spirit, the upward arc, during which the Spirit is learning to dominate Matter and to see it as an expression of itself, the tendency is still towards greater differentiation, but at the same time towards spiritualisation and escape from materiality.

During the later part of the upward arc, when differentiation has been finally accomplished by the division of the Divine Life into separate human entities, the tendency is towards unity, as well as towards greater spirituality. In this stage the Spirit, having learnt perfectly how to receive impressions through matter, and how to express itself through it, and having awakened its dormant powers, learns to use these powers rightly in the service of the Deity, or Logos. Diagram XXXI illustrates the process.

This principle, as said, is repeated over and over again, at many levels. It may be seen in operation in successive Chains, Rounds, Globes, Races, and Sub Races, and careful research would probably reveal many other examples of its application.

Thus, as the student will have observed, the seven Planetary Chains of a Scheme of Evolution follow the process of descent and ascent through the grades of matter, or planes (*vide* Diagram V, p. 7).

In the case of the Globes of any particular Chain, a glance at Diagrams III and V, pp. 12, 16, shows that the Globes of each Chain descend and ascend again in degree of materiality.

The three pairs of Globes, A and G, B and F, C and E, in any Chain, are closely allied; but the one may be regarded as the rough sketch, the other as the finished picture.

The first globe, Globe A, may be regarded as the root or seed of the Chain, the last globe, Globe G, as the flower or fruit of the Chain. Hence Globe A is sometimes spoken of as the root-world; Globe G, similarly, is sometimes called the seed-world because, though it produces the fruit or final product of its own Chain, it also provides the seed for the following Chain.

In the first three globes of a Chain forms are evolved; in the fourth globe the gulf is spanned between the forms and overbrooding spirits, and the forms become ensouled; in the later three globes, the spirits shape the forms to their will.

Globe A of a Chain is sometimes called also the archetypal globe, because it contains the archetypes of the forms to be produced in the round. But, as H. P. Blavatsky says: "the word" archetypal, must not be taken here in the sense that the Platonists gave to it, *i.e.*, the world as it existed in the mind of the Deity; but in that of a world made as a first model, to be followed and improved upon by the worlds which succeed it physically" (*The Secret Doctrine*, I, 221, note).

When we come to consider more in detail the Races and Sub-Races, we shall find precisely the same principle in operation.

In our Scheme of Evolution, we are at present just past the middle point. The central point of the whole Scheme would clearly be in the Fourth Chain, Fourth Round, Fourth Globe, Fourth Root-Race. Hence the actual middle point fell in the time of the last great Root-Race, the Atlantean. As the Âryan race, the latest to appear on this Globe, is the Fifth Root-Race of the Fourth Globe, the human race as a whole is very little more than half way through its evolution, measuring this purely arithemetically in terms of the stages through which it has to pass. With the question of the length of time taken by these various stages we shall deal a little later.

Our Chain, being the fourth, is the Chain of struggle, of balance, the Chain in which Spirit and Matter are to be interlinked and interwoven, so that the highest and the lowest, the two poles of nature, shall join in one complex being, Man - Man being the startingpoint for the higher evolution.

Moreover, as we have just seen, we are now on the Fourth Globe, so that we are at the very centre of the struggle, at the point of keenest combat and of greatest difficulty, truly on the planetary Kurukshetra. Here, on the Fourth Globe of the Fourth Chain in the Fourth Round, must be waged the greatest conflict of Spirit and Matter, to end in the triumph of Spirit.

We may note also that there is another cyclic process at work in the evolution of the seven kingdoms through the rounds of a chain. Each round evolves one kingdom to the highest perfection of its own type; future types, not belonging to that round, are of course present, but more or less embryonic, compared with their future development in succeeding rounds. Thus, in our chain, the kingdoms will be perfected as follows:

- Round I-First Elemental Kingdom.
- Round II-Second Elemental Kingdom.
- Round III-Third Elemental Kingdom.
- Round IV-Mineral Kingdom (our present round).
- Round V-Vegetable Kingdom.
- Round VI-Animal Kingdom.
- Round VII-Human Kingdom.

Amplifying this a little, we may say that, in the first round, on Globe A the Builders give the seven archetypal forms for each kingdom. On Globe B they multiply forms containing the essentials of each archetype; on C they densify these forms; on D they shape them in still denser matter; on E they make them more complex and slightly refine them; on F they build them of finer matter; on G they finally perfect them.

This is the method of their work on every round, though on the first round only do they gather the matter round themselves, and dwell in it awhile to assimilate it. In this work they use only the four upper sub-planes of the matter of each plane.

We shall deal with the above process, in rather more detail, when we come to describe the Earth Chain, round by round, globe by globe.

Another complication is due to the fact that in each round an additional force is poured into the atoms, bringing an additional spirilla in the atoms into activity. Thus in

Round I-One spirilla becomes active.

Round II-Two spirillæ become active.

Round III-Three spirillæ become active. and so on. We, being in Round IV, have four sets of spirillæ active.

Also, each round appears, in the case of humanity, to be especially devoted to the cultivation of a certain principle. The present (fourth) round, for example, should be devoted chiefly to the cultivation of kâma, emotion and desire, and the next, the fifth, to intellectual advancement. This general rule, however, seems to have been modified in the present instance, because, owing to the coming of the Lords of the Flame (as will be explained more fully in a later chapter) we are a long way in advance of the programme marked out for us, and are already engaged in the unfolding of the intellect. At the same time it must be said that the intellect we now have is infinitesimal compared with what the average man will possess at the culminating point of the next or fifth round.

Yet another important principle must be taken into account. In each sub-plane there are seven sub-divisions; now the body of a man, whilst containing matter of all the sub-planes and all the subdivisions, will show activity only in the sub-divisions corresponding to the number of chains or rounds experienced, or being experienced.

Thus, in the second chain, second round, a man will be able to use in his astral and mental bodies only the first and second sub-divisions of each sub-plane of astral and mental matter. In the third round he will be able to use the first, second and third, though not so fully in the case of the third as he will do in the third round of the third chain, and so on.

In the Earth chain, the fourth, in the second round, man was working with the first and second subdivisions of each sub-plane, and feebly in the third and fourth. Not until the seventh Race of the seventh round will he possess the splendid body in which every particle will thrill responsive to himself, and even then not as perfectly as in later chains.

The present writer regrets that he is unable to construct a diagram illustrating the above process, as the data do not appear to be sufficiently detailed. For the present, therefore, we must content ourselves with the general principle that, in the course of evolution, man takes up the various sub-divisions of each sub-plane progressively, and becomes able to express himself through them in steadily increasing measure.

Further, the matter of any given sub-plane, say the second, appears to be taken into use to a certain standard of perfection, which is presumably a progressively higher standard, in the second round of each chain, and in the second chain itself as a whole.

CHAPTER XV

TIMES AND DATES

VERY little information is available regarding the times occupied by Chains, Rounds, Globe-periods, or even Races. Hence it is at present scarcely practicable to attempt even to estimate the exact lengths of these enormous expanses of time.

In exoteric Hindu books definite numbers are given, but H. P. Blavatsky states that it is impossible to rely fully on these, because there are involved other and esoteric considerations, which the writers do not take into account.

Whilst there is no direct information upon the point, there is yet some reason to suspect that the time of the Rounds is not an invariable quantity, but that some are shorter than others. It has been thought that those in front of us will probably not be so long as those through which we have already passed. But here again we have no certain information, and it seems useless, with so little data before us, to speculate.

We may, however, note in this connection, as possibly throwing some light on the question of the times spent in the earlier and in later portions of evolution, that investigations have shown that whilst the earlier radical changes in the constitution of man extended over vast periods of time, the later changes connected with the development of civilisations passed much more rapidly; where developments of civilisations take thousands of years, the earlier and more radical changes occupied actually millions.

For the present we can do little more than enumerate the few statements made by various authorities, and this we shall now proceed to do. According to occult records, the solar system has a life stretching behind it for some 1,955,884,703 years - say, rather less than 2,000 million years.

300 million years are said to have passed away in this Fourth Round, on Globe D (the Earth). The Lords of Venus came to the Earth some 16½ million years ago.

The separation of the sexes, in the middle of the Third Root-Race (the Lemurian) took place some 16½ million years ago. But that separation was a long process which extended over more than a million years, and took place at different times in different parts of the world.

About a million years is the period allowed for our present Fifth Root-Race (the *Āryan*).

850,000 years have passed since the submersion of the last large island, part of the continent of Atlantis, the Ruta of the Fourth Root-Race, the Atlanteans.

The small island of Daitya was destroyed about 270,000 years ago.

The catastrophe previous to the sinking of Poseidonis commenced 75,025 B.C.

The sinking of Poseidonis took place in 9,564 B.C.

The Secret Doctrine gives the following:

	Years
Krita Yuga (Age)	1,728,000
Tretâ Yuga	1,296,000
Dvâpara Yuga	864,000
Kâli Yuga. . . .	432,000
	<hr/>
Total, making a Mahâ Yuga (Great Age)	4,320,000 71
	<hr/>
71 Mahâ Yugas form the period of reign of one Manu	306,720,000 14
	<hr/>
The reign of 14 Manus embraces the duration of 994 Mahâ Yugas, or.	4,294,080,000
Add Sandhis, <i>i.e.</i> , intervals between the reign of each Manu, which amount to 6 Mahâ Yugas, or	25,920,000
	<hr/>
Total of reigns and interregnums of 14 Manus is 1,000 Mahâ Yugas, which constitute a Kalpa, <i>i.e.</i> , one Day of Brahmâ	4,320,000,000
Add one Night of Brahma	4,320,000,000
	<hr/>
One Day and Night of Brahmâ	8,640,000,000 360
	<hr/>
360 such Days and Nights make one year of Brahmâ	3,110,400,000,000 100
	<hr/>
100 such Years constitute the whole period of Brahmâ's Age, <i>i.e.</i> , one Mahâ Kalpa	311,040,000,000,000

The above figures are said by H. P. Blavatsky to be "exoteric" and "accepted throughout India, and they dovetail pretty nearly with those of the Secret Works. The latter, moreover, amplify them by a division into a number of Esoteric Cycles, never mentioned in Brâhmanical popular writings . . . [These], in their details, have of course never been made public."

At, the present time we are said to be at the very close of

the *Âryan Kâli Yuga*. The following tabular statement supplies a condensed history of the animal and plant life on the earth, bracketed - according to Haeckel - with the, contemporary rock strata. Two other columns give the contemporary races of man, and such of the great cataclysms as are known to occult students.

Rock Strata		Depth of Strata, Feet	Races of Men	Cataclysms.	Animals.	Plants.
Laurentian Cambrian Silurian	Archilithic or Primordial	70,000	First Root-Race which being astral could leave no fossil remains.		Skull-less Ani- mals.	Forest of gigantic Tangles and other T h a l l u s Plants.
Devonian Coal Permian	Palæotic or Primary	42,000	Second Root-Race, which was etheric.		Fish	Fern Forests.
Triassic Jurassic Cretaceous	Mesolithic or Secondary	15,000	Third Root-Race, or Lemurian	Lemuria is said to have per- ished before the beginning of the Eocene age.	Reptiles.	Pine and Palm Forests.
Eocene Miocene Pliocene	Cenolithic or Tertiary	5,000	Fourth Root-Race, or Atlantean.	The main Continent of Atl- antis was destroyed in the Miocene period, about 800,000 years ago. Third great catastrophe about	Mammals.	Forests of Deciduous Trees.
Diluvial or Pleistocene Alluvial	Quaternary or Anthropolithic	500	Fifth Root-Race, or Aryan.	80,000 years ago. Final submergence of Poseidonis 9564 B.C.	More differen- tiated Mammals.	C u l t i v a t i d Forests.

CHAPTER XVI

THE PLANETARY CHAIN LOGOI AND OTHER HIGH OFFICIALS

THE SEVEN PLANETARY CHAIN LOGOI

WE saw in Chapter VII that the Solar Logos contains within Himself seven Planetary Logoi, who are, as it were, centres of force within Him, channels through which His force pours out. Yet at the same time there is a sense in which they may be said to constitute Him.

The Hindu speaks of them as the Seven Sons of Aditi—the eighth was Mârttânda, the Sun itself, each Son, or Âditya, having his own "house." They have been called also the Seven Spirits in the Sun; in ancient Egypt they were termed the Seven Mystery Gods. In the religion of Zoroaster they were the Seven Amshaspends. Among the Jews, they are the Seven Sephiroth; among the Christians and Muhammedans, they are the Seven Archangels.

Every religion points to them as standing round the manifested Trinity of the Logos, forming the Viceroys, as it were, of Îshvara in the vast empire of the Solar System, each with his own kingdom, each administering his own department. In modern Theosophy they are called the Seven Planetary Logoi, because they have ever been identified with the seven sacred planets, which are their physical bodies. With these planets, and their relation to the Scheme of Evolution to which they belong, we have already dealt in preceding chapters. Each of these Logoi thus has his own house, and rules over his own kingdom, a definite department of the Solar System.

The matter of the Solar System, which we have seen composes the vehicles of the Solar Logos, also composes the vehicles of the Planetary Logoi; for there is no particle of matter anywhere in the System which is not part of one or other of them. This, of course, is true of every plane; we may take the astral plane as an example, because its matter is sufficiently fluid to answer our purpose, and at the same time it is near enough to the physical to be not entirely beyond the limits of our physical comprehension.

Every particle of the astral matter of the System is, as we have stated, not only part of the astral body of the Solar Logos, but it is also part of the astral body of one or other of the Seven Planetary Logoi. Hence in every man's astral body there are particles belonging to each of the seven Planetary Logoi: but the proportions vary infinitely. Each Monad originally came forth through one Planetary Logos (*vide The Causal Body*, p. 26) and he will continue all through his evolution to have *more* of the particles of that Logos than of any other; in this way people may

be distinguished as primarily belonging to one or other of these seven great Powers.

In the Planetary Logoi certain psychic changes periodically occur; possibly they correspond, on some infinitely higher level, to in-breathing and out-breathing, or to the beating of the heart with us down here on the physical plane. However that may be, there seems to be an infinite number of possible permutations and combinations of them.

Some of these periodic changes are more rapid than others, so that a very complicated series of effects is produced. It has been observed that a clue to the operation of these great cosmic influences at any given moment is afforded by the movements of the associated physical planets.

Now since our astral bodies are built of the very matter of their astral bodies, it follows that no one of these Planetary Logoi can change astrally in any way without thereby affecting the astral body of every man in the world, though of course more especially those in whom there is a preponderance of the matter expressing that particular Planetary Logos. Recollecting that the same thing is true of all the other planes, we can realise how important to us are the motions and changes of the Planetary Logoi.

There are, in addition, other influences which affect the matter of the planes and sub-planes, which we shall consider further in our next section.

THE LIPIKA AND THE DEVARÂJAS

P. Blavatsky writes of a certain order of supernal Beings whom she calls the Lipika, or Lords of Karma. We are further told that in the administration of karma their agents are the four (in reality seven) Devarâjas or Regents of the Earth.

Each of these is at the head of a certain vast group of devas and nature-spirits, and even of elemental essence. For purposes of explanation let us take one plane only, the astral, bearing in mind that precisely similar considerations apply to all the other planes as well. Now astral matter as a whole is especially under the control of one of these Devarâjas, but, as the astral plane is the sixth of our seven planes, so the sixth *sub-plane* of every plane is also to a certain extent under the direction of the same Devarâja, because that sub-plane bears the same relation to the plane of which it is a part as the astral plane as a whole does to the set of seven planes. Hence for every sub-plane there are two influences—the influence of the ruler of the whole plane, and the sub-influence of the ruler of the sub-plane.

But we saw in the preceding section that the matter of every plane and sub-plane is especially affected by one or other of the seven Planetary Logoi. Hence any particular portion of matter is subjected to three distinct influences: (1) one of the seven Planetary Logoi; (2) the Devarâja of the plane as a whole; (3) the Devarâja of the sub-plane to which that portion of matter

belongs.

It is clear from the above that a very large number of distinctly marked varieties of matter exist on every plane, so that, even taking no account of the further sub-divisions of matter (which also exist), we have the possibility of an almost infinite number of combinations of matter, out of which the various bodies of man are constructed. Hence, incidentally, whatever may be the characteristics of any given ego, he is always able to find an adequate expression of himself.

Diagram XXXII shows the matter of one plane only, the sixth or astral plane, as affected by the three influences named.

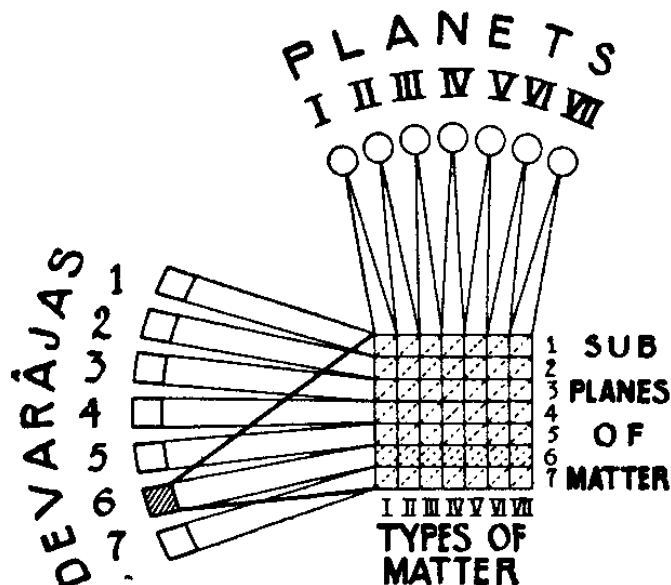

DIAGRAM XXXII.—The Influences acting on One Plane (the Astral).

First, we have what is often described as the *vertical* influences of the seven Planets, dividing the matter of the whole plane into seven types, rays or "colours."

Second, we have the *horizontal* influence of the sixth Devarâja, ruling the plane as a whole. In the diagram this is indicated by the shading of Devarâja No. 6 and by corresponding shading over the whole astral plane.

Third, we have the influence of the sixth Devarâja again affecting more especially the sixth sub-plane. This is indicated by the double shading of the sixth sub-plane, showing that this sub-plane is subject to a double influence from the sixth Devarâja. Similar considerations apply of course to each of the other six planes.

Diagram XXXIII is an attempt to illustrate the three influences affecting the whole of the seven planes and their sub-planes. For diagrammatic purposes, however, it was found necessary to show the two influences from the Devarâjas as coming from two directions, the fact that these come in reality from the same source being indicated by the dotted lines joining the two sources shown in the diagram.

We thus see that the matter of, for example, the *first* sub-plane of the *first* plane is subjected to a double influence of the same kind, just as the matter of the *second* sub-plane of the *second* plane is subjected to a double influence of another kind;

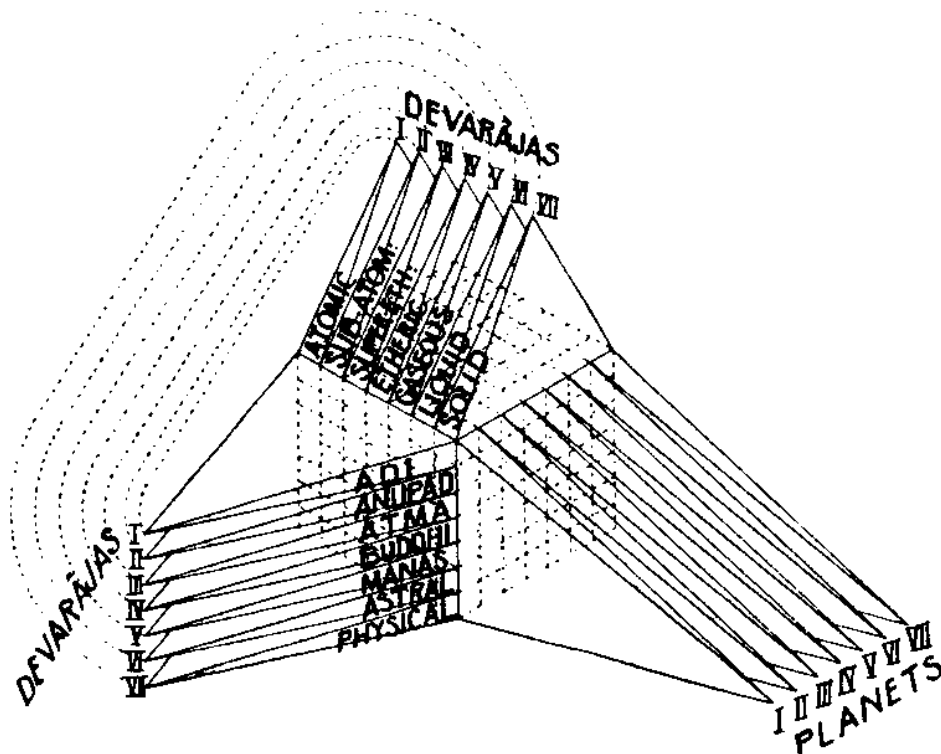

DIAGRAM XXXIII.—The Influences acting on the Seven Planes of Matter.

and so on with the other sub-planes. There will, therefore, be something distinctive about the first sub-plane matter of the first plane, the second sub-plane matter of the second plane, the third sub-plane matter of the third plane, and so on: though what this distinctive characteristic is, is not (so far as the present writer is aware) yet known. For the present we merely draw attention to the point by shading the sub-planes which are subjected to the double influence.

The changes in the consciousness of the Planetary Spirits are visible in the long history of human races as regular cyclic changes in the temperament of the people and the consequent character of their civilisation. Thus in a given Root-Race the Seven Rays are preponderant in turn—perhaps more than once—but in the period of that dominance of each Ray there will be seven sub-cycles of influence. For example, whilst the Fifth Ray is ruling in the history of a Race, the central idea of that Ray, and probably a religion founded on it, will be prominent in the minds of men; but that time of predominance will be subdivided into seven periods, the first coloured by the idea of the First Ray, the second by that of the Second Ray, and so on. In the fifth subdivision the influence of the Fifth Ray will of course be at

its purest and strongest. It is possible that these divisions and sub-divisions may correspond with sub-races and nations, but this correspondence has not been actually traced out as yet.

THE STAFF

Just as every general officer has, quite apart from the regular officers who hold various commands under him, a special set of officers who form his staff, whose duty it is to be in personal attendance upon him, and to be ready at any moment to do anything that he may require, or to fill any vacancy that may occur, so the Solar Logos also has His staff—a number of Adepts who are not in the service of any particular Chain, yet are ever prepared to be sent to the aid of any that need assistance. Members of the staff thus give themselves to the immediate service of the Logos, to be used by Him in any part of the Solar System, His servants and messengers, living but to carry out His will and to do His work over the whole System which He rules.

To join the staff is one of the seven possibilities open to a man who has "reached the further shore." It seems to be considered a very hard path, perhaps the greatest sacrifice open to the Adept, and is therefore regarded as carrying with it great distinction.

A member of the General Staff has no physical body, but makes one for himself by Kriyâshakti—the "power to make"—of the matter of the globe to which he is sent. The Staff contains beings at very different levels, from that of Arhatship upwards. There are some who dedicated themselves to it on reaching Arhatship in the Moon Chain; others who are Asekha Adepts (Masters); others who have passed far beyond that stage in human evolution.

The need for the provision of such a Staff arises probably, among many other reasons unknown to us, from the fact that in the very early stages of a Chain—especially of one on the downward arc—or even of a globe, more help from outside is needed than is required later. Thus, for example, on the First Chain of our Scheme, the attainment of the First Initiation being the appointed level of achievement, none of its humanity reached the Asekha level, much less Buddhahood—which, of course, is much further on. Consequently the office of the Buddha and other high offices had to be filled by entities from outside the Earth Scheme. Later Chains also were helped in a similar way. The Earth Chain itself will in due course have to provide high Officials for the earlier Chains of other Schemes, as well, of course, as yielding the normal supply for its own later Globes and Rounds. In fact, from the Earth Occult Hierarchy two members already, within our own knowledge, have left the Earth, either to join the General Staff, or lent by the Head of the Earth Hierarchy to the Head of the Hierarchy of some other Globe outside the Earth Scheme.

CHAPTER XVII

MANUS

THE word Manu is a generic term used for a class of directing Intelligences of many different grades or ranks. Thus the Manu who presides over the evolution of seven successive Chains is the Manu of a Scheme of Evolution, though He is usually spoken of as the Planetary Chain Logos. The term is not a very accurate one; because it seems to imply that He is in charge of one Chain, whereas He has in His charge seven Chains. A more accurate term would be the Logos of a Scheme of Evolution, but, as said, the name that is generally employed is that of Planetary Logos, or Planetary Chain Logos.

Working under the Planetary Chain Logos is a Manu who has in his charge the development of one planetary Chain. Him we may term the Manu of a Chain, or simply a Chain Manu.

Under Him again there is a Manu responsible for the evolution of one Round, and He is known as a Round Manu.

Working under His orders there is another grade of Manu in charge of a Globe-Period, which, of course, includes the seven Root-Races. He may be termed the Manu of a Globe-Period or World-Period.

Once again, under His direction there is a separate Manu in charge of each Root-Race: He is usually called a Race Manu, or Manu of a Root-Race.

Each of these Manus takes charge of the department of evolution allotted to Him, superintending its formation and growth.

The Sanskrit word manvantara means literally the period between two Manus: hence it may be applied at many levels. It is customary, however, to confine the term manvantara to the duration of one Chain, *i.e.*, the time taken for the streams of life to pass seven times round the seven globes.

To the greater period of seven successive Chains, *i.e.*, to a Scheme of Evolution, the term mahâman-vantara is applied. Mahâmanvantara means simply great manvantara.

If the reader will refer to Diagram XXI on page 58, he will observe that each of the units there shown, from the largest circle at the head down to the rectangles representing Root-Races, may be considered to represent also the Manu or Official in charge of those units.

We may now consider a little more fully some of the many functions pertaining to the offices enumerated.

It appears that, in the Seventh Round of a Chain, the Being, to whom has been given the title of "Seed-Manu," of the Chain, takes into His charge the humanity and lower classes of living beings which have been evolving in that Chain. The present writer has been unable to ascertain whether the Seed-Manu is the same as the Chain Manu, or a separate Official. However that may be, we

are here evidently dealing with a specific function, and if we keep that in mind, it does not seem of much moment whether this function is performed by the Chain Manu or by a separate Seed-Manu.

The Seed-Manu, then, gathers up into Himself, at the conclusion of a Chain, all the results of evolution on that Chain, transports them into the Inter-Chain sphere, the Nirvana for the inhabitants of the dying Chain, nourishes them with in Himself, and finally hands them over at the appointed time to the Root-Manu of the next Chain. Again, the present writer is not quite clear whether the Root-Manu is the same as the Chain Manu or a separate Entity. We shall, therefore, continue to use the word Root-Manu to describe the function, no matter by Whom that function is performed.

The Root-Manu, receiving the products of evolution from the Chain just concluded, follows out the plan of the Seed-Manu, determining the times and places for introducing the various classes of entities into His kingdom in the succeeding Chain.'

The function of the Seed-Manu, therefore, is to direct all the preparations for the transfer of the huge population from one Chain to the next Chain; that of the Root-Manu is to make all arrangements for the reception of that population, and to introduce the many classes of entities into His Chain in the proper sequence and at the proper times.

The following is an example of the work of a Seed-Manu. The Seed-Manu of the Moon Chain appeared to have a vast plan, according to which He grouped the entities from the Moon Chain, dividing them, after their last deaths, into classes, sub-classes, and sub-sub-classes, in a quite definite way, apparently by some kind of magnetisation. This set up particular rates of vibration, and the people who could work best at one such rate were grouped together, and those who worked best at another rate were similarly grouped, and so on. These groups appeared to form themselves automatically in the heaven-world, much as fine dust will form itself into figures on a vibrating disc under the impact of a musical note.

In this gigantic task the Seed-Manu was aided by many great Beings, who obeyed His directions, the whole vast plan being carried out with an order and an inevitableness unspeakably impressive.

The results of the preceding Chain are thus gathered up within the aura of the Seed-Manu, and are arranged, tabulated, filed-if one may use such terms-in perfect order. Upon these intelligences, of many grades, inward-turned, living a strange slow subjective life, without idea of time, the Seed-Manu pours intermittent streams of His stimulating magnetism. A continuous stream would break them into pieces, so it plays on them and then stops, and they doze on for perhaps a million years, slowly assimilating it; then another stream plays on them, and so on and on, for millions upon millions of years. To those who were able to watch that strange scene, many analogies occurred: bulbs laid carefully on shelves, inspected from time to time by a gardener;

cots in a hospital, visited day by day by a physician. Eventually the time will come when the great Gardener will give out His bulbs for the planting, the planting ground being the next Chain, and the bulbs living souls.

The work of a Manu, bearing groups of entities from one Chain, Round, etc., to the succeeding Chain, Round, etc., reminds us of the stories in the Hindu Purânas of the Manu crossing the ocean in a ship, bearing with Him the seeds of a new world, and of the Hebrew records of Noah, preserving in an ark all that was needed to repopulate the earth after a flood. The legends preserved in the Scriptures of religions are often based on true happenings in the occult world.

In bringing over from the Moon Chain to the Earth Chain a class of human beings with "basket-work" causal bodies, an interesting point was noted. (N B.- A basket-work causal body is one which is not fully formed, but consists of lines of matter somewhat resembling a basket, hence the name. *Vide The Causal Body*, p. 85.)

The "shelves" on which the "bulbs" were stored were clearly of higher mental matter; but, as there is no continuity of mental matter between Chains, the bulbs brought over in the Seed-Manu's aura were brought through a higher plane-the buddhic-and so the basket-work of the Moon mental matter would be disintegrated, and would have to be re-formed before the entities concerned could begin their career on the Earth Chain. Thus, having slept for ages in the buddhic world, they would be re-clothed in basketwork of the equivalent Earth Chain matter.

The Seed-Manu appeared also to be choosing out the Officials for the next Chain, those who, in the long course of evolution, would pass ahead of their fellows and become Masters, Manus, etc., in the various Rounds and Races. He evidently selected many more than would be needed, just as a gardener chooses out many plants for special culture, out of which a later selection may be made. In the Moon Chain, most of this choosing was done on Globe D-the Moon itself.

Enormous periods of time are occupied in the work between Chains; so vast are they that the mind perforce takes refuge in the idea that time has no fixed existence, but is long or short according to the working of the consciousness of the being concerned. In the Inter-Chain Nirvana the really working consciousnesses are those of the Seed-Manu of the Chain just completed and of the Root-Manu of the Chain which is to follow.

The Great Plan is in the mind of the Seed-Manu, and the Root-Manu, as said, receives it from Him and works it out in the new Chain over which He presides.

The Seed-Manu determines the contents of each group of entities and the order of its dispatch to the new Chain; the Root-Manu distributes the groups, or "ship-loads", as they are sometimes called, as they arrive successively.

The Seed-Manu of the Moon Chain is Chakshushas; He is aided by Officials who report to Him how the members of any special division have responded to the Influences He has thrown upon them

during the Inter-Chain Nirvana.

The principle followed, in the dispatch of entities to the new Chain, is that the least advanced in "age," or development, are sent out first, in order to inhabit the most primitive forms; the more advanced follow when the forms have evolved to a higher state. Examples of the working of this principle will be given later.

The Root-Manu of the Earth Chain is Vaivasvata; He must not be confused with the Manu of the same name who is in charge of the Fifth Root-Race and the wonderful Âryan civilisation. The Root-Manu Vaivasvata directs the whole order of evolution in the Earth Chain; He is a Being from the Fourth Chain of the Venus Scheme of Evolution. Two of His Assistants came from the same Chain, and a third is a high Adept who "attained" early in the Moon Chain. The Manu of the fourth Root-Race (the Atlantean) was also an Adept from Venus. He is known as the Lord Chakshusha Manu, is Chinese by birth, and of very high caste.

A Root-Manu of a Chain must achieve the level fixed for the Chain or Chains on which He is human, and has become one of its "Lords." Then He becomes the Manu of a Race; then a Pratyeka Buddha; then a Lord of the World; then the Root-Manu; then the Seed-Manu of a Round, and only then the Root-Manu of a Chain. As already explained, He directs the Manus of Rounds, who distribute the work among the Manus of Races.

Furthermore, each Chain yields a number of successful human beings, the "Lords of the Chain," some of whom devote Themselves to the work of the new Chain, under its Root-Manu. Thus, for example, there are for the Earth Chain seven classes of Lords of the Moon, *i.e.*, "successes", from the planets of the Moon Chain, working under the Root-Manu of the Earth Chain.

Before the Manu of a Chain or of a Round commences the task appointed for Him, He examines the part of the thought-form of the Logos which refers to His work, and brings it down to some level within easy reach for constant reference. The same thing is done at a somewhat lower level by the Manu of each World or Globe, and of each Root-Race.

Each Manu thus has before Him, at His own level, the model towards which He has to build, and He endeavours to make His World or His Race, as the case may be, as nearly as possible an exact copy of what the Logos intended it to be. In view of the fact that He has to build with existing materials, He can usually approach the required perfection only by degrees; hence the earlier efforts at the formation of a race, for example, are often only partially successful.

To take a specific example, in the first Round of the Earth Chain the Manu in charge brought down all the archetypes for the whole of the Chain. Although many of these will not be fully perfected down here until the seventh Round, the germs of all of them were already present even in the first Round.

For every kingdom in nature He selected a certain set of forms, which He wished to have vivified during the first Round, with the view of developing from them at later stages everything

which the Logos wished the Earth Chain to produce.

The scheme of these forms, materialised down to a level where they could use them, was handed over to certain of the Lords of the Moon, who were entrusted with the work of setting the activities of the first Chain in motion. They made these forms in each of the seven Globes of that first Round and, as they made them, the animal-men from the moon entered them, solidified and used them, and from them generated others which could be inhabited by the moon-animals which occupied the stages below them. We shall deal with and explain "animal-men," "moon-animals," etc., at a later stage of our study. For the moment we may just note that these are names to designate classes of entities at certain levels of development, as they left the Moon Chain.

It should be noted that the Manu of the Root-Race starts and sets the type not only of each Root-Race, but also of each sub-race, by incarnating in it Himself.

CHAPTER XVIII

BUDDHAS, MAHÂCHOHANS AND BODHISATTVAS

We have seen that Manus are practically autocratic monarchs who are concerned with the evolution of the different races of men. They represent the ruling department, which guides all natural evolution, changes the face of the surface of the globe, builds and destroys continents, raises fresh races, controls the destinies of nations, shapes the fate of civilisations, balances up from time to time the great accounts between the races and the nations, and rules the outer destinies of men.

Another great department is that of religion and education, and it is from this that all the greatest teachers have come, and that all religions have been sent forth. The Official at the head of this department, with a rank two grades above that of Master or Asekha Adept, is variously known as the Bodhisattva, the Jagat Gurû, the World Teacher, the Christ. He watches over the spiritual destinies of mankind. He either comes Himself or sends one of His pupils to found a new religion when He decides that one is needed. His benediction flows over the whole of the living religions of the time; and may be regarded as a kind of steady pressure, so that the power employed will flow as though automatically into every channel anywhere and of any sort which is open to its passage. He thus works simultaneously through every religion, utilising all that is good in the way of devotion and self-sacrifice in each. In addition, He appoints one Master or another as the special guide and protector of a special religion.

For each Root-Race there is a Manu and a Bodhisattva, and these are respectively the brain and the heart of the Heavenly Man who emerges as the result of the evolution of each Root-Race. In the Heavenly Man, as in the man on earth, there are seven centres, and each of these centres is represented by an official of the Occult Hierarchy. The Heavenly Men so formed are the true inhabitants of the solar system, the mind-born sons of the Planetary Logoi, destined themselves to be the Planetary Logoi of the future; of them we shall be living conscious component parts, each nevertheless having the fullest liberty and the highest possible activity.

In addition to the Manu and the Bodhisattva of a Root-Race, there is also another Official, Who stands at the same level, known as the Mahâchohan. He it is Who directs the minds of men so that the different forms of culture and civilisation shall be unfolded according to the cyclic plan. The Manu is spoken of as the Head, the Bodhisattva as the Heart, and the Mahâchohan as the Hand or the five Fingers; all are active in the world; moulding the Race into one organic being, the Heavenly Man, as it is called.

The Manu follows the line of the First Ray, the Bodhisattva that of the Second Ray, whilst the Mahâchohan stands at the head

of the remaining five Rays.

The Bodhisattva of the past, who gave the earlier, religions of the Fifth, or Aryan Root-Race, is now the Lord Buddha. Whilst He was the World Teacher, He came to the first sub-race as Vyâsa, and founded Hinduism, the religion of the Sun; He taught as Thoth, known later as Hermes, in Egypt, founding the religion of Light; He came as Zoroaster to Persia, 31.000 years ago, proclaiming the religion of Fire; He came as Orpheus to Greece, teaching by Music and Sound, and founding the Orphic Mysteries.

He came forth for the last time in Hindûstân; there to reach the Illumination of the Buddha, and with Buddhism closed the ancient cycle, leaving to His Successor the continuance of the work of the World Teacher.

The deep reverence and the strong affection felt for the Lord Gautama Buddha all over the East are due to two facts. One of these is that He was the first of our humanity to attain the stupendous height of Buddhahood, and so He may truly be described as the first-fruits and the leader of our race. For all previous Buddhas had belonged to other humanities, which had matured on earlier chains.

The second fact is that for the sake of hastening the progress of humanity, He took upon Himself certain additional labours of the most stupendous character, the nature of which it is impossible for us to comprehend.

The attainment of Buddhahood is not simply the gaining of enlightenment; it is also the taking of a great and definite Initiation; the man who has taken that step cannot again incarnate upon earth, but hands over His work to His successor, and usually passes away altogether from any connection with earth.

The Lord Gautama, however, still remains to a certain extent within touch of the world. Once in each year, at the festival of Wesak, at the first full moon in May, He still shows Himself to the brotherhood of Adepts, and pours down His blessing upon them, to be passed through them to the world at large. And He may still be reached in certain ways by those who know how. A full account of the Wesak ceremony is to be found in *The Masters and the Path*, pp. 431-446.

The successor of the Lord Buddha, the present Bodhisattva, is the Lord Maitreya, known to the West as the Christ. He came first as Krishna in the Indian plains, and then to the fifth or Teutonic sub-race of our present Root-Race as the Christ in Palestine. He struck pre-eminently the notes of the value of the individual, and of self-sacrifice. He is, so far as we know, destined to appear again on earth and give religious teaching suited to the particular needs of the sixth and of the seventh sub-races of the fifth Root-Race. Then He will pass on and become the Buddha of the sixth Root-Race.

The Manu and the Bodhisattva of the sixth Root-Race will be the present Chohans Morya and Koot Hoomi respectively—the two Chohans most intimately concerned with the foundation and the work of the Theosophical Society.

The following is the list, so far as it is known; of the Bodhisattvas and Buddhas of our evolution:

On Globe F of the Moon Chain, the Buddha was the Lord Dipankara, who came from the fourth chain of the Venus Scheme, and was a member of the General Staff. The list for the Earth Chain, Fourth Round, Globe D (the Earth) is as follows:

Root-Race.	3	Bodhisattva	3	Buddha
	3		3	
	3		3	
	3		3	
3	3	The Lord Kashyapa	3	--
4	3	The Lord Guatama	3	The Lord Kashyapa
5	3	The Lord Maitreya	3	The Lord Guatama
6	3	(Chohan) Koot Hoomi	3	The Lord Maitreya
7	3	--	3	(Chohan) Koot Hoomi
	3		3	

A Buddha is an Official who superintends much more than a humanity; He is the Teacher of Devas; or Angels, as well as of men, so the fact that a given humanity may be at a very low stage of evolution does not do away with the need for that high office. He takes charge of the special work of the Second Ray for the whole world, devoting Himself to that part of it which lies in the higher worlds, while He entrusts to His assistant and representative, the Bodhisattva, the office of, world Teacher for the lower planes.

He who becomes a Buddha must, thousands of years beforehand, have made his vow to a living Buddha, and it is said that from that time onward the influence of the Buddha overshadows him, and that when in due course he attains Buddhahood the great influence of the spiritual Buddha hovers over the incarnate Buddha.

CHAPTER XIX

THE LORD OF THE WORLD AND HIS ASSISTANTS

THERE is on our Earth Globe a great Official, known as the Lord of the World, who represents the Solar Logos, and is in absolute control of all the evolution that takes place upon this planet, not only that of humanity and of the animal, vegetable, mineral and elemental kingdoms, but also of the great non-human kingdoms of the nature-spirits and the devas. He must not, of course, be confused with the Spirit of the Earth, who uses the earth as a physical body and who is a totally distinct entity, as will be explained more fully in Chapter XXVI.

We may image the Lord of the World as the true KING of this world, there being under Him ministers in charge of different departments. He is known as Sanat Kumâra, the "Youth of sixteen summers," the "Eternal Virgin-Youth." The word Kumâra is a title, meaning Prince or Ruler. Together with others, whom we shall mention presently, He came to the Earth Globe, from the Venus Scheme of Evolution, in the middle of the Fourth (present) Round, and in the middle of the Third Root-Race (the Lemurian). The purpose of the coming was (1) to quicken mental evolution, (2) to found the Occult Hierarchy of the Earth, (3) to take over the government of the Earth Globe. With these several functions we shall deal presently.

With Sanat Kumâra came three Kumâras, His Pupils, who serve as his lieutenants or assistants. They stand at the level of the Buddha, and are called Pratyeka or Pachcheka Buddhas, and are themselves destined to be our three Lords of the World when humanity is occupying the planet Mercury; for there are three Lords of the World during each world-period. The present holder of the office is already the third.

There were also some 25 or 30 other Adepts, in graded order, together with about 100 ordinary human beings who were in some way affiliated to these Great Ones, or perhaps had been individualised by Them, and who were merged in the ordinary humanity of the earth.

Most of Them stayed on the earth only through the critical period of our history (which will be explained presently); a few still remain to hold the highest offices of the Great White Brotherhood, until the time when men of our own evolution shall have risen to such height as to be capable of relieving their august visitors.

As the *Catechism* of the Inner Schools says: "Out of the seven Virgin-Men (Kumâra) four sacrificed themselves for the sins of the world and the instruction of the ignorant, to remain till the end of the present Manvantara. Though unseen, they are ever present. . . . These are the Head, the Heart, the Soul, and the

Seed of undying Knowledge (Jnâna). Thou shalt never speak, O Lanoo, of these great ones before a multitude, mentioning them by their name. The wise alone will understand."

The Lord of the World is the Head of the Brotherhood, which is not only a body of Men, each of whom has His own duty to perform in guiding evolution on the earth, but is also a stupendous unity, a fully flexible instrument in the Lord's hand, a mighty weapon that He can wield. He is known also as the One Initiator, though in the case of the first and second Initiation it is open to Him to depute some other Adept to perform the ceremony for Him; but even then the Officiant turns and calls upon the Lord at the critical moment of the conferring of the degree.

He is the Force which drives the whole world-machine, the embodiment of the Divine Will. His consciousness comprehends all the life on our globe. In His hands are the powers of cyclic destruction, for He wields Fohat in its higher forms and can deal directly with cosmic forces outside our chain. He appears to work usually with humanity en masse rather than with individuals, but when He does influence a single person He appears to do so through âtmâ, not through the ego.

None of the Lords from Venus, as They are often called, took incarnation in our humanity at all. They did not - in fact could not - take human bodies; instead, They built for Themselves vehicles like the highest ideals of the human form in appearance, yet absolutely unlike it in that they are uninfluenced by time and are incapable of change or decay.

Although these bodies have been worn for 16 million years, they still remain precisely as on the day when they were made-by Kriyâshakti. They must be regarded as a kind of permanent materialisation; bodies built like statues, and yet to the sight and the touch presenting the appearance of ordinary living men.

Their dwelling-place "was and is the Imperishable Sacred Land, on which ever shines down the Blazing Star, the symbol of Earth's Monarch, the changeless Pole, round which the life of the Earth is ever spinning." Needless to say, the pole mentioned is not the geographical pole, but what we may call the spiritual pole of the earth, and at present it is an oasis in the Gobi Desert, called Shamballa.

Once in every seven years the Lord of the World conducts at Shamballa a great ceremony somewhat similar to the Wesak event, but on a still grander scale and of a different type, when all the Adepts and even some Initiates below that grade are invited, and have thus an opportunity to come into touch with Their great Leader. At other times He deals only with the Heads of the Official Hierarchy, except when for special reasons He summons others to His presence.

We mentioned previously that in any given world-period there are three successive Lords of the World. The task of the Third of these is far greater than those of the First and Second Lords, because it is His duty to round off satisfactorily that period of evolution, and to deliver over the countless millions of evolving

creatures into the hands of the Seed-Manu, who will be responsible for them during the inter-planetary Nirvana, and will hand them in turn to the Root-Manu of the next globe.

The Third Lord of the World, having fulfilled this duty, takes another Initiation entirely outside of our world, and attains the level of the Silent Watcher. In that capacity He remains on guard for the whole period of a round, and it is only when the life-wave has again occupied our planet and is again ready to leave it that He abandons His strange self-imposed task, and hands it over to His Successor.

The Lords from Venus are known also by other names, such as the Lords of the Flame, the Children of the Fire-Mist, the Sons of the Fire.

We come now to deal with the effect produced on the mental evolution of our Globe by the coming of the Lords of the Flame. This we may divide into two parts: first, the effect produced on humanity generally, and secondly, the impetus given to the animal kingdom.

Dealing first with humanity, we should, in the natural course of events, be devoting ourselves in this, the fourth Round, to the development of the emotions—the astral principle: the next Round, the fifth, would normally be that especially devoted to the development of mind—the mental principle. But so great was the influence brought to bear by the Lords of the Flame on the mental evolution, that progress was advanced a whole Round, the intellect having already been considerably developed in the present fourth Round. At the same time it must be understood that the intellect of which we are now so proud is infinitesimal compared with that which the average man will possess at the culminating point of the next or fifth round.

We may note here that there is another great Official on the earth even greater than the Sanat Kumâra, though little is known of Him or His function. H. P. Blavatsky writes: "Higher than the 'Four' is only ONE on earth as in Heaven - that still more mysterious and solitary Being" - the Silent Watcher.

We turn now to consider the effect produced on the animal kingdom by the advent of the Lords of the Flame.

In *The Secret Doctrine* the Lords of the Flame are spoken of as projecting the spark into the mindless men and awakening the intellect within them. This somewhat curious expression should not mislead us into supposing that They threw some part of Themselves into the human bodies. They acted rather as a, kind of magnetic stimulus. They shone upon the people as the sun shines upon flowers, and drew them up towards Themselves, thus enabling them to develop the latent spark and to become individualised. In other words, They so quickened the germs of mental life that these burst into growth, and there followed the great downrush through the Monad that we call the Third Life-Wave, causing the formation of the causal body, the "birth" or "descent of the ego" for all those who had come up from the animal kingdom (*vide The Causal Body*, Chapter XIII). So instantaneous was the response that the expression arose that They "gave" or "projected", the

spark of mind. But the spark was not given, rather was it fanned into flame; the nature of the gift was the quickening of the germ already present in nascent humanity, the effect of a sun-ray on a seed, not the giving of a seed.

The power of the Logos was concentrated by the Lords of the Flame, much as the sun-rays might be concentrated by a lens, and under that influence the responsive spark appeared.

The Lords of the Flame are the true Mânasaputras, the Sons of Mind, coming, as They did, from the fifth, the mental Round of Venus. The Lords from Venus thus enabled millions of entities to become human: without Their influence, these entities would still have been in the animal kingdom. For on the Earth globe, in the fourth Round, a departure was made from what we may call the straightforward method of evolution, a curious break in the regular and methodical order of things. This being the midmost point of evolution marked the last moment at which it was possible for members of what had been the lunar animal kingdom to attain individualisation. Consequently a sort of strong effort was made, a special arrangement was made to give a final chance to as many as possible.

In order to achieve this, the conditions of the first and second Rounds were specially reproduced, in miniature, in the First and Second Root-Races - conditions of which, in the earlier Rounds, these back-ward egos had not been able fully to take advantage. Now, with the additional evolution which they had undergone during the third Round, some of them were able to take such advantage, and so they rushed in at the very last moment, before the "door was shut," and just became human.

It was in order to assist in this very busy time, just before the "closing of the door," that the Lords of the Flame came to the earth.

Naturally these individualised entities will not reach any high level of human development, but at least when they try again in some future Chain, it will be some advantage to them to have had even this slight experience of human life.

Among other plans for the helping of evolution, the Lords of the Flame brought from Venus certain additions to our kingdoms. They imported wheat as a specially desirable food-stuff for humanity, and They also brought in bees and ants-the bees to modify the vegetable kingdom and assist in the fertilisation of flowers, as well as to provide a pleasant and nutritious addition to human food.

It was explained in *The Causal Body*, p. 63, that both bees and ants live in a manner quite different from that of purely terrestrial creatures, in that with them the Group-Soul animates the entire ant or bee community, so that the community acts with a single will, and its different units are actually members of one body in the sense in which hands and feet are members of the human frame. It might, in fact, be said that they have not only a Group-Soul, but a group-body also.

Our human evolution has attempted to imitate all these importations, but with somewhat indifferent success. In imitating

bees we have produced wasps, and in imitating ants we have produced "white ants," as well as curious little ant-flies, which are almost indistinguishable from them. The nearest that we have been able to get to wheat is rye, but the crossing of the wheat with other native terrestrial grasses has given us oats and barley.

CHAPTER XX

THE EARTH SCHEME OF EVOLUTION:

THE FIRST CHAIN

WE have now before us, in broad outline, the plan of evolution in our Solar System, both as regards the "field," *i.e.*, the successive chains, rounds, and globe-periods, and also as regards the streams of life which enter the field and evolve through the various kingdoms of nature until they reach, as separate individuals, the human stage, and beyond that the super-human stages.

So far we have, as said; dealt with the whole gigantic plan in very broad outline only, omitting many modifications and details of the main principles. It will now, therefore, be useful to describe in detail what is known of the Earth Scheme of Evolution, explaining as we go the many modifications which, in practice, are introduced into the main outline so far as we have already sketched it.

We shall commence with a description of the First Chain of the Earth Scheme of Evolution.

THE FIRST CHAIN

A glance at Diagram V, p. 16, will show that the globes of the first chain consisted of 2 globes of *âtmic* matter, 2 of buddhic matter, 2 of higher mental, and 1 of lower mental matter.

Although we call them globes, and give them the usual names, A, B, C, etc., they are more like centres of light in a sea of light, foci of light through which light is rushing, wrought of the very substance of light and only light; yet modified by the flood of light which courses through them. They are as vortex-rings, yet the rings are but light, distinguishable only by their c whirling, by the difference of their motion, like whirlpools made only of water in the midst of water; save that they are whirlpools of light in the midst of light.

From the above faint description, and from the composition of the globes, it is evident that the conditions are so different from all that we now know in our present (fourth) chain as to make adequate description extremely difficult if not impossible. The forms are tenuous, subtle, changing; the matter "the stuff which dreams are made of."

It is difficult even to mark off the successive rounds; they seem to fade one into the other like dissolving views, and are marked only by slight increases and diminutions of light. Progress is very slow, recalling the Satya Yuga of the Hindu Scriptures (*vide* p. 205), where a life lasts for many thousands of years without much change. The entities unfold very slowly, as rays of magnetised light play upon them. It is like a gestation,

like growth within an egg, or of a flower-bud within its sheath. For this chain may be thought of as future worlds in the matrix of thought, worlds that are later to be born into denser matter. Hence this, the first chain, is sometimes called the Archetypal Chain.

Diagram XIV, p. 41, indicates that, of the seven streams of life that enter this chain, one has just emerged fresh from the Logos, the other six having been brought over from a preceding Scheme of Evolution—a Scheme of which we know nothing at present, except that it must have existed.

We may especially note that our present humanity, having been in the animal kingdom in the third chain, and in the vegetable kingdom on the second chain, was in the mineral kingdom in this, the first, chain.

Whilst all grades of egos exist in the first chain, yet the absence of the lower levels of matter, *i.e.*, of astral and physical matter, makes a notable difference in evolutionary method. For here everything not only starts but also progresses "above," there being no "below" and no forms, in the ordinary sense of that word. There are instead centres of life, living beings without stable forms.

There are no astral or physical worlds from which impulses can surge "upwards," calling down the higher in response to ensoul and use forms existing on the lower levels - as happens in the conditions in which we are at present living. The nearest approach to such action is on Globe D (lower mental) where the animal-like thought-forms reach upwards, attracting the attention of the subtle centres floating above them. Then more of the life of the spirit pulses out into the centres, and they anchor themselves to the thought-forms and ensoul them, and the thought-forms become human.

The chief interest of the chain seems to be the evolution of the Devas - those who live habitually on these high levels; the lower evolutions seem to play a sub-sidiary part.

Humanity is much influenced by these, mostly by their mere presence, and by the atmosphere created by them; the vibrations set up by the Deva kingdom play on the lower human types, strengthening and vivifying them. Occasionally a Deva may take a human being almost as a toy or a pet; on Globe D (lower mental), for example, a Deva deliberately helped a human being, transferring matter from his own body into the human, and thus increasing its responsiveness and susceptibility. Such a Deva would be a Rûpa-Deva, living normally in the lower mental world.

Those kingdoms, which we must perforce speak of as vegetable and mineral, are really composed of mere thoughts, with the Monads who dream in them, as it were, floating over them, sending down faint thrills of life into the airy forms. It seems that the Monads are now and again forced to turn attention to them, to feel through them, to sense through them, when some external touch compels a drowsy notice.

The thought-forms are, as we saw previously, as models in the Mind of the Ruler of the Seven Chains, products of His

meditation. In and through them, Monads, who have acquired permanent atoms in some previous Scheme, become vaguely conscious.

Vague as is this consciousness, there are differences in it. The lowest grade can scarcely be called consciousness, the life in the thought-forms resembling what we should now call earth, rocks, stones. Monads touching these can scarcely be said to be aware of anything through them, save of pressure, drawing from them a dull stirring of life, showing itself as resistance to pressure, and thus different from the yet duller life in the molecules not attached to Monads, and sensing no pressure.

In the next grade, corresponding to what we now call metals, the sense of pressure is stronger, and the resistance to it a little more definite. There is almost an effort to push outwards against it, a reaction causing expansion. When this sub-conscious reaction is in several directions, the thought-model of a crystal is formed.

From the point of view of the consciousness in the mineral, only the sub-conscious reaction is felt. From the point of view of the consciousness outside the mineral, trying to feel the reaction from outside, it records itself as a vague discontent at the pressure, and a dull resentful effort to resist and push against it. Probably the Monadic life, seeking expression, vaguely feels displeasure at its frustration.

Glancing forward for a moment, we may note that Monads attached to crystals in this chain do not enter the second chain in the lowest forms of vegetable life, but only in the higher; passing through these, they enter the third chain (the Moon Chain) at its middle point as mammals, becoming individualised there, and taking human birth in its fifth round. This affords a good example of the principle of the "over-lapping" of the kingdoms.

The "thoughts" of minerals are, as one would expect, not immobile, but mobile; thus a hill will turn over or float away or change its form; consequently there is no "solid" earth, but a shifting panorama—as is appropriate to worlds which come no lower than the lower mental level.

The level of attainment set for the humanity of the first chain was that of the First Initiation. Those who reached this standard entered on one or other of the Seven Paths, one of these (the fifth) leading to work on the second chain as the builders of the forms of its humanity, this being part of the work of what is known as the Fifth Creative Hierarchy (vide *The Causal Body*, p. 40).

These were called by H. P. Blavatsky Asuras, which means literally "living beings." Later the term was confined to living beings in whom intellect, but not emotion, was developed.

These Asuras, acting on the second chain as Barhishads, served also on the third chain as Agnisvâttas.

Those entities evolving in the first chain who did not reach the First Initiation entered the second chain for their own further evolution at its midmost point, and led its humanity,

reaching liberation at the close of the chain. Some of these, in turn, worked on the third chain in building the forms of its humanity.

It is noteworthy, as we saw in Chapter XIII, that on the first chain there were, so far as is known, none who dropped out as "failures," *i.e.*, there was no Judgement Day of the First Order (*vide* p. 67).

The first chain is called by the Hindus the first body of Brahma, the Body of Darkness or of Night. It is known also, as said before, as the Archetypal Chain.

CHAPTER XXI

THE SECOND CHAIN

THE second chain (*vide* Diagram V, p. 16) is made up of 2 buddhic globes, 2 higher mental globes, 2 lower mental globes, and 1 astral globe.

In the first round, on Globe D (astral) great surging clouds of matter were a noticeable feature. In the following round they became denser, more brilliantly coloured, more responsive to vibrations which shaped them into forms, though it is difficult to say whether these forms were vegetable or animal. Thus things with the general appearance of vegetables moved about with the freedom of animals, though apparently with little, if any, sentiency. Not being anchored to physical matter - the lowest matter of the chain being astral - they were very mobile.

Much of the work of the chain was on higher levels, a vitalising of subtle matter for future use, showing but little effect on the lower forms. Just as now elemental essence is used to build astral and mental bodies; so in the second chain the Kâma and Rûpa Devas were seeking to differentiate themselves more fully by using the clouds of matter and living in them. They came down, sub-plane by sub-plane; into denser matter, but in this were not using the human kingdom.

Even at the present time a Deva may ensoul a whole countryside, and such action was very general in the second chain. The astral and lower mental matter formed the bodies of the Devas, and was all the time changing and intermingling.

Incidentally permanent atoms of minerals, vegetables and even animals rooted themselves in the bodies of the Devas, growing and evolving by so doing. The Devas seemed to take no particular interest in them; any more than we interest ourselves in the evolution of microbes in our physical bodies. Occasionally, however, some interest was shown in an animal, and its capacity to respond increased rapidly under such conditions.

The humanity of the chain lived in close contact with the Devas, who still dominated the evolutionary field, both Kâma and Rûpa Devas influencing strongly, but for the most part unintentionally, human evolution.

Passion showed itself in many human beings who had astral bodies on Globe D, and its germs were visible also in animals. Differences existed in the capacity to respond to vibrations sent out by the Devas, but changes were very gradual and progress was slow. Later, when buddhic consciousness unfolded, there was communication between the Earth Scheme and the Venus Scheme. In fact, certain entities came from the Venus Scheme to the Earth Scheme in the second chain, but whether they belonged to the Venus humanity or were members of the "Staff" is not known.

Those of us who are now human were in the vegetable kingdom in the second chain. In that vegetable life there was a dim awareness of forces playing upon it, and a certain compulsion

towards growth. In some, there was a feeling of the want to grow—a desire to flower, as one might say. In others, there was a slight resistance to the line of growth impressed, and a vague groping after another, self-chosen direction.

Some tried to use any forces that contacted them, and in their germinal consciousness held that all around existed for them. Others tried to push out in a direction which attracted them, and were frustrated and vaguely resentful. Thus, for example, one, forming part of a Deva, was observed to be hindered, since the Deva was naturally arranging things to suit himself, and not any constituents of his body. On the other hand, from the obscure view-point of the vegetable, the Deva's proceedings were as incomprehensible as the weather is to us in these days, and often as troublesome.

Towards the end of the chain, the more highly developed vegetables were showing a little mind, in fact a fair baby intelligence, recognising the existence of external animals, liking the neighbourhood of some and shrinking from others.

There was also a craving for more cohesion, evidently the result of the downward rush of life into matter of greater density, the Will working in Nature for descent into denser levels.

The level of attainment set for the humanity of the second chain was the Third Initiation. Those who reached this level entered one of the Seven Paths, one of these, as before, leading to work in the next chain.

The second chain is known as the Body of Light, or of Day, and also as the Creative Chain.

Its "successes" were the Agnisvâta Pitris, some of whom became the Sixth Creative Hierarchy (vide *The Causal Body*, p. 40), and had to deal with the intellectual evolution of men in the fourth (Earth) chain.

The student will recollect also that the "successes" of the first chain, Asuras, serve again as Barhishads on this, the second, chain.

Those who did not attain full success, entered the third chain at the round suitable to the stage they had reached.

In the seventh round of the second chain a considerable number dropped out from its humanity as "failures," having fallen too far behind to find suitable forms for them to continue in the second chain. They went on later into the third chain, as men.

The foremost of the animal kingdom individualised on the second chain, began their human evolution on the third chain, passing through its lower kingdoms very rapidly and becoming men. They then led the evolution of the third chain until the "failures," and later those who had fully succeeded, came in successively and became the leaders.

The foremost from the vegetable kingdom of the second chain entered the third chain animal kingdom as mammals, in the fourth round. The remainder came in during the first round as animals of the lower types.

The other kingdoms moved on one stage, according to the

standard plan, the First Elemental Kingdom being as usual supplied by a new stream of life from the Logos.

CHAPTER XXII

THE THIRD (MOON) CHAIN

THE FIRST FIVE ROUNDS

THE Third, or Moon, Chain descends a stage in materiality, possessing 2 higher mental globes, 2 lower mental globes, 2 astral globes, and one physical globe. The middle globe (D), the scene of the greatest activity of the chain, still survives as the Moon, the Moon at present being only what is left after much loss of material, its inner core after the disintegration of the crust, much diminished in size, on its way to total destruction in the seventh round of the Earth chain.

The level set for the humanity of the Moon Chain was that of the Arhat, or Fourth Initiation.

The Moon Chain is known also as the Body of Twilight, the Sandhyâ, the "successes" being known as Barhishad Pitris, and being concerned, in the case of those who worked on the Earth Chain, with guiding physical evolution, for which purpose they entered the Seventh Creative Hierarchy (*vide The Causal Body*, p. 40).

The student will recollect that the successes of the first chain, Asuras, served on the second chain as Barhishad Pitris, and on the third chain as Agnishvâta Pitris.

Little is known of the first five rounds except concerning the animal kingdom, and we shall therefore confine ourselves to that. This kingdom was of course the mineral kingdom in the first chain, the vegetable kingdom in the second chain, and is now ourselves, the human kingdom in the Earth or fourth chain.

The crest of this particular life-stream enters the Moon chain as mammals at its middle point, appearing on Globe D (the Moon) in the fourth round (*vide Diagram XXXIV*). These mammals are curious creatures, small but extraordinarily active. The most advanced are monkey-like in form, making enormous leaps.

These fourth round creatures are as a rule at first scaly in skin, the skin becoming later frog-like. Then the most advanced types develop bristles, which form a very coarse harsh fur.

The air is altogether different from our present atmosphere, heavy and stifling, reminding one of choke-damp; but it obviously suits the Moon inhabitants.

The small mammals we are considering have long bodies and short legs, a mixture of weasel, mongoose and prairie-dog, with a short scrubby tail, altogether clumsy and ill-finished. They are red-eyed, and able to see in the darkness of their holes; coming out of the holes, they raise themselves on their hind legs, which form a tripod with their short strong tail, and turn their heads from side to side, sniffing.

They are fairly intelligent, and the relations between them and men, in one district at least, seems more friendly than

between wild animals and men now on earth. They are not domesticated, but do not scuttle away on the approach of men. In other parts, where men are mere savages, eating their enemies when they can get them, and animals when man-flesh is unobtainable, the wild creatures are timid, and fly from human neighbourhood.

After this first stage, they become creatures that live much

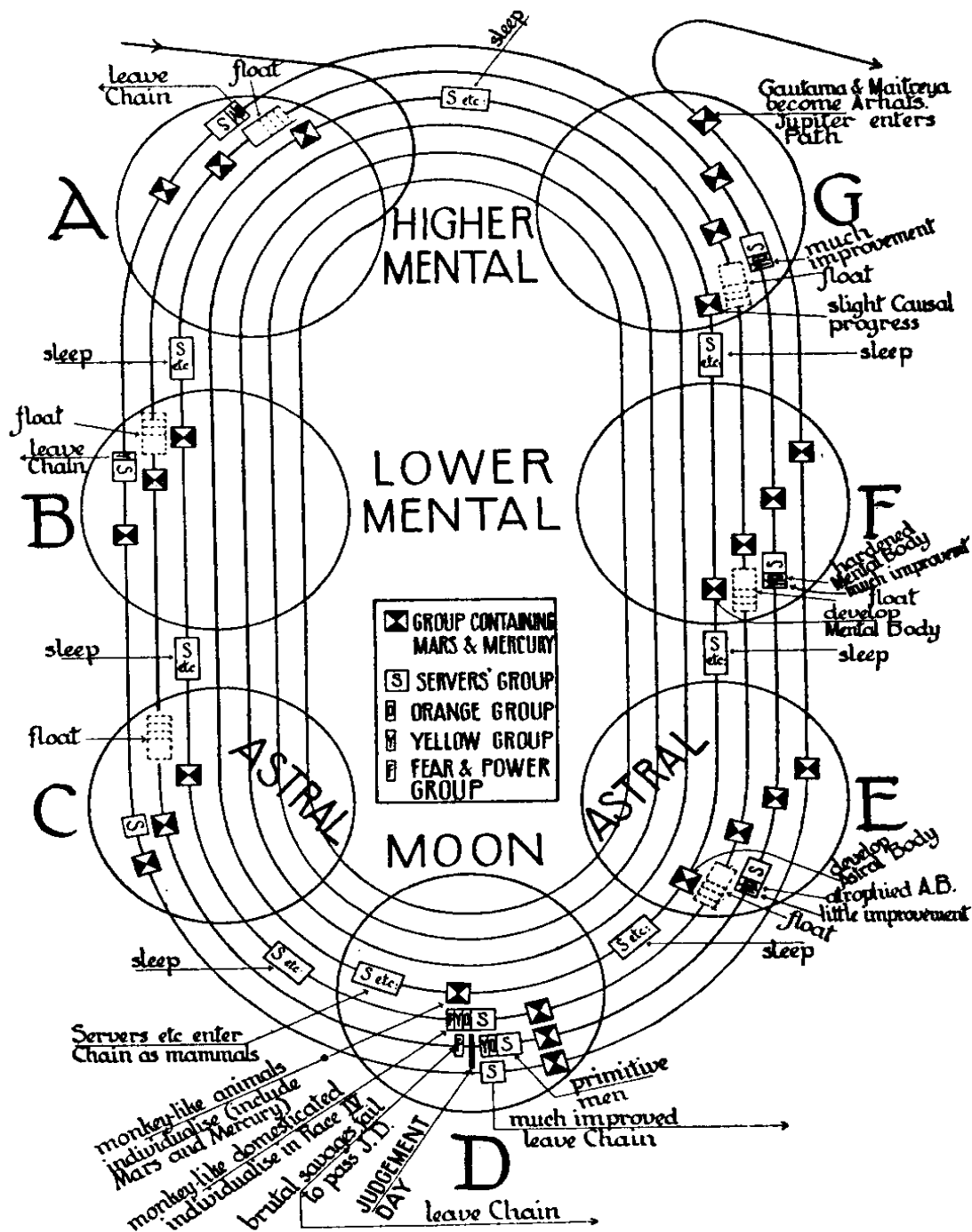

DIAGRAM XXXIV.—The "Servers" and Other Groups in the Moon Chain.

in trees, the limbs double-jointed, the feet padded, with a

thumb-like projection at right-angles to the limb, like the spur of a cock, armed with a curving claw. Running rapidly along the underside of branches, the animal uses its claw to hold on by, the remaining part of the feet being useless. But when moving on the ground it walks on the pad, the spur being above ground level and therefore not impeding movement.

Animals more highly developed than these, and far more intelligent, monkey-like in form, live habitually in human settlements, serving in various ways the men to whom they are strongly attached.

This class of animals become individualised on Globe D of the fourth round; on Globes E, F and G, they develop human astral and mental bodies, the causal body, though fully formed, showing but little growth. They have three rounds of development as human beings and, as we shall see later, leave the Moon Chain in the middle of the seventh round (*vide* Diagram XXXIV). In this group are those entities, known as Mars and Mercury, who later will be the Manu and the Bodhisattva respectively of the Sixth Root-Race on the earth in the fourth round. They, and probably many others, become Masters in the Earth Chain.

After leaving Globe D, the animals of the group first-named practically sleep through the remainder of the fourth round and through the first three globes of the fifth round. Very shortly after physical death, they lose their astral and inchoate mental bodies and, having no causal, they sleep in a sort of devachan, without touch with the manifested worlds.

In the fifth round, on Globe D again, they appear as large monkey-like creatures, leaping forty feet at a bound, and appearing to enjoy making tremendous springs into the air.

In the fourth human race on Globe D they become domesticated, acting as guardians of property and playmates of children, and developing intense affection for their human masters. Amongst them are those known later as Heracles who, saving his master's life by action, individualises through Will; Sirius who, by intelligence fed by love, individualises through Intellect; and Alcyone and Mizar who, by one-pointed devotion, individualise through Wisdom. These are examples of the three "right" ways of individualising (*vide* *The Causal Body*, p. 86).

Such entities as these are of course henceforth definitely human, and have the same causal bodies which they still use. (N.B. This is not quite accurate, but sufficiently so for our present purposes. For the slight qualification necessary, *vide* p. 86.) On Globe E they are human beings; but do not take any definite part in its ordinary life. They float about in its atmosphere like fishes in water, but are not sufficiently advanced to share in its normal activities. Hence they are not born as children of the human inhabitants of Globe E, who, we may note in passing, are not prepossessing in appearance.

Their new astral bodies on Globe E are produced by a kind of protuberance formed round the astral permanent atom. Some consolidation and improvement is effected in their astral bodies as they float in the atmosphere of Globe E; similarly in the

mental body as they float in the atmosphere of Globe F, and likewise in the causal body on Globe G. This improvement is shown in the descent through the atmospheres of Globes A, B and C of the sixth round, wherein the matter drawn into each body is better of its kind, and is more coherent. But, as said, the effective progress is on Globe D, whereon physical matter is once more donned.

Among the advanced animals in the fifth round, living in contact with primitive human beings, there is a group of especial interest because they individualise in one of the "wrong" ways, viz., through intense vanity, which stimulates the imitative faculty to an abnormal degree, causing a strong feeling of separation, until the effort to be distinguished from others calls down an answer from the higher levels, and the ego is formed. They were permitted to individualise apparently because, if they had continued as animals, they would have become worse instead of better. They were clever enough in their way, but possessed little of any quality other than pride. They form what is known as the "orange" group, because their causal bodies show little colour beyond a slight tinge of orange. They numbered rather more than two millions.

After death they dream away the interval until they are re-born in the sixth round, again on Globe D.

Another set of animals individualised through admiration of the human beings with whom they came into contact, and whom they try to imitate. There is no strong love, or wish to serve, but much desire to be taught, and great readiness to obey. When they individualise, through the growth of intelligence, the intellect is ready to submit to discipline, to co-operate, to see the advantages of united effort, and the necessity for obedience. They carry into their intermediate existence this sense of united work and willingness to submit to direction, to their own great advantage in the future. They form what is known as the yellow group, because their causal bodies show a clear, bright and rather golden yellow. They numbered rather less than three million.

They were not devoid of emotion, but their emotions were selfish rather than loving. They seem to have developed in their mental bodies qualities which should have had their roots in their astral bodies, founded in and nourished by love and devotion.

There was also a third group, numbering rather more than three millions, whose causal bodies were mainly pink. Presumably, therefore, they individualised through affection.

A fourth group individualised through fear, which stimulated the mind to discover ways of escaping from cruelty. In other cases animals individualised through an intense desire to inflict pain, as yielding a sense of power over others. This group is known as the fear and power group.

We shall pursue the history of these groups in the sixth round of the Moon Chain, working out their new humanity along the lines determined by their respective methods of

individualisation.

It appears that only the three right kinds of individualisation, caused by a downflow from above, were in the Plan, the forcing upward from below, the "wrong" ways having been brought about by the wrong-doing of man.

In the higher civilisation of the fifth round there were many communities scattered over the globe, leading distinctly primitive lives. Some were kindly, although little developed, fighting vigorously when attacked, whilst others were savage and continually at war, apparently for the mere lust of bloodshedding and cruelty.

In addition to these various communities, some large, some small, some nomad, some pastoral, there were more highly civilised people, living in cities, carrying on trades, ruled by settled governments. There did not appear to be much of what we should call a nation. A city and a considerable, sometimes a very extensive, area round it, with scattered villages, formed a separate State, and these States entered into fluctuating agreements with each other as to trade, mutual defence, etc.

Thus, for example, near to the Equator is a great city with a large extent of cultivated land round it. The city is built in separate quarters according to the class of inhabitants. The poorer people live out of doors during the day, and at night, when it rains, crawl under flat roofs, reminding one of dolmens, which lead into oblong holes, or chambers, cut out of the rocks. These are like underground burrows going a long way and communicating with each other, a regular labyrinth. The entrance door is made of a huge slab of stone, resting on upright smaller stones as pillars. The rooms are massed together, thousands of them, lining the two sides of one long circular street, and forming the outside ring of the city.

The higher classes live in the domed houses within this ring, built on a higher level, with a wide terrace in front, forming a ring right round like the road below. The domes are supported on short strong pillars, carved all over, the carving showing a fairly well-advanced civilisation. An immense number of these domes are joined together at the lower edge, and make a kind of community city, a belt, with again a circular terrace above its inner edge.

The centre of the city is its highest part, and there the houses themselves are taller, with three domes, rising one above another. The central one has five domes, each successive dome being smaller than the one below it. The upper ones are reached by steps inside one of the pillars on the ground floor, and winding round the central pillar above. They seem to have been hewn out of the living rock.

In the higher domes no provision seems to be made for light and air. The highest dome has a kind of hammock hanging from the centre, and this is the prayer room. It appears that anyone who is praying must not touch the ground during his prayer.

This is evidently the highest humanity of the Moon; they will reach the Arhat level - the goal set for the third chain -

and will later become the Lords of the Moon. They are already civilised and know how to write.

Those of the lunar humanity who were in the fifth round entering the Path were in touch with the Hierarchy for the time, who had come over from the second chain to help evolution on the third. These lived on a lofty and practically inaccessible mountain, but Their presence was realised by those on the Path, and was generally accepted as a fact by the intelligent humanity of the time.

Their disciples reached Them when out of the body, and occasionally one of Them descended into the plains, and lived for a while among men. The dwellers in the central house of the city described were in touch with These, and were influenced by Them in matters of serious concern.

CHAPTER XXIII

THE MOON CHAIN: SIXTH ROUND

NO information having been published regarding Globes A, B and C, we resume our study with Globe D (the Moon itself) in the sixth round.

The group of primitive human beings, whose history we are now more especially following, and who individualised in the fifth round, on Globe D, are now born in the sixth round as men of a simple and primitive type, though not savage or brutal (*vide* Diagram XXXIV). Their hair is ragged, lips thick, noses squat and wide at the base. They live on an island.

They do not fight among themselves except when food runs short; but there is much fighting against invaders from the mainland, who are particularly brutal cannibals, fiendishly cruel, and much dreaded. The islanders kill all whom they take as prisoners, but do not, like the mainland savages, either torture them living or eat them dead.

The savages of the mainland are from those who individualised by fear in the fifth round.

Among the islanders life is communal, and they live promiscuously. The intervals between death and re-birth are very short, a few years at most, and they are re-born in the same community. The second life shows advance, for help comes from outside, which quickens their evolution.

A stranger - Mars - a man of much higher type, comes to the islanders, teaches them the use of fire and cultivation of the soil. Later, Mercury comes also, and under his influence the people become a little more civilised.

After a time Mars returns to his own country and city. This was distinctly civilised, with large and handsome buildings, and many shops. Animals were used, both for draught and for riding. Commerce was carried on with other cities, and canals connected the city with others at great distances.

The city was divided into quarters, the different classes inhabiting different parts of it. In the centre were people of a distinctly high type, of blue complexion. The ruler and his highest nobles were in touch with a group of people living secluded in a somewhat inaccessible region.

These people, some of whom will be known later as the Lords of the Moon, when they reach the stage of Arhat, were themselves pupils of still more exalted Beings, who had come thither from some other sphere, and who had evidently reached a far higher stage of evolution than that of the Arhat.

It was by These that the Ruler of the city, the capital of a large empire, was ordered to exterminate the savages of the mainland coasts. This was duly effected. The islanders, previously mentioned, were then transferred from their island to the mainland, and incorporated as a colony of the Empire.

This was part of the operation of the Judgement Day of the

Moon Chain, when those who were incapable of further progress on that chain were eliminated from it. Under this category came the savages, bodies suitable for their low stage of evolution being no longer available. As they died, they passed into a condition of sleep. Many bodies of similarly low type were destroyed by seismic catastrophes which laid whole districts waste, the population of the globe being thus much diminished.

From this time forward all was directed towards pressing forward as rapidly as possible those who remained, preparing them for evolution on the next chain, the Earth Chain.

The whole tribe partially civilised by Mercury managed to escape the dropping out, while in the city, Heracles and Sirius, and the households and dependents of Mars and Mercury, also just slipped over the dividing line, by virtue of their attachment to their leaders.

The orange group, who individualised in the fifth round by vanity, were mostly born into city populations, drifting together by similarity of tastes and contempt for others, though their vanity led to much quarrelling among themselves.

Separateness became much intensified, and the mental body strengthened in an undesirable way, becoming more and more of a shell, shutting out others.

As they repressed animal passions, the astral body grew less powerful, animal passions being starved out by a hard and cold asceticism, in stead of being transmuted into human emotions; sex-passion, for example, was destroyed instead of being changed into love. Hence, life after life, they had less feeling, and physically tended towards sexlessness. Whilst they developed individualism to a high point, this very development led to constant quarrels and rioting.

They formed communities, but these broke up again, because no one would obey; each wanted to rule. Any attempt, by more highly developed people, to help or guide them, led to an outburst of jealousy or resentment, it being construed as a plan to manage or belittle them. Pride grew stronger, and they became cold and calculating, without pity and without remorse.

On Globe E (astral) they remained in activity, but only for a short time, the astral body being dwarfed until it became atrophied.

On Globe F (lower mental) the mental body became hardened and lost plasticity, leading to a curious truncated effect, by no means attractive, like a man, oddly enough, who had lost his legs from the knee downwards, and had his trousers sewn up over the stumps.

The yellow group, individualised in the fifth round by admiration, was docile and teachable, and also tended to come mostly into city populations; they formed at first the better class of labourers, rising through the lower middle class to the upper, and developing intelligence to a very considerable extent. They were free from excessive pride, so that their auras, as mentioned previously, were not orange, but clear, bright and rather golden yellow.

Whilst not devoid of emotion, their feelings led them to co-operation and obedience to those wiser than themselves, being selfish rather than loving. Their intelligence induced them to co-operate for their own advantage, rather than to spread happiness among others; hence their orderliness and discipline quickened their evolution. But, as we saw before, they gave the impression of having developed in their mental bodies the qualities which should have had their roots in their astral bodies, founded in and nourished by love instead of by self-interest. Hence their astral bodies were insufficiently developed. Accordingly they could profit but little by their sojourn on Globe E (astral), but considerably improved their mental bodies on Globe F (lower mental).

Globes E, F and G were most useful to the groups of egos who had individualised in one of the three "right" ways, and were hence developing in an all-round, rather than in a lop-sided fashion, as was the case with those who had individualised in one of the "wrong", ways, so far as intelligence was concerned; for these egos would be compelled later on to develop the emotions they had in the early days either stunted or neglected.

In the long run, all powers have to be completely developed; and in gazing at the huge sweep of evolution from nescience to omniscience, the progress or the methods at any particular stage lose the immense importance which they appear to have as they loom through the mists of our ignorance and propinquity.

As Globes E, F and G in the sixth round came successively into activity, very great astral and mental progress was made by the more advanced egos. The Day of Judgement having eliminated from the chain the backward egos, there were no hopeless laggards to be a clog on evolution, and growth was steady and more rapid than before.

Much of the vegetation in the sixth round belonged to what we should now call the fungus family, but was gigantic and monstrous. There were trees that grew to a great height in a single year, and which were semi-animal. Branches when cut off writhed like snakes and coiled round the men who had been using the axe, contracting as they died. Red sap, like blood, gushed out under the strokes of the axe. The texture of the tree was fleshy; it was carnivorous, seizing any animal that touched it, coiling its branches round it like an octopus and sucking it dry. Only very strong and skilful men were entrusted with the dangerous harvesting of the crop. When the branches had died, the rind was stripped off and made into a kind of leather, the flesh being cooked and eaten.

Many of the growths we must call plants were semi-animal and semi-vegetable. One had a large umbrella-like top, with a slit in the middle which allowed the two halves, armed with teeth, to open out; it bent over, with the jaws gaping open, seized any animal that brushed against it, and closed its jaws over it. Then the stem straightened itself, and the closed halves again formed the umbrella-like surface, while the animal was sucked dry. The men cut the trees down whilst the jaws were closed, the skill

required for the feat consisting in leaping out of reach, as the top swooped down to seize the aggressor.

Insect life was voluminous and gigantic, and served largely as food for the carnivorous trees. Some insects were fully two feet long, and of most formidable aspect, being greatly dreaded by the human inhabitants.

The houses were built as quadrangles, enclosing very large courtyards; these were covered in with strong network, and in the seasons when the large insects were about, the children were not allowed to go outside these enclosures.

The year was, roughly, of about the same length as at present. The relation of the globe to the sun was similar, but was different as regards the constellations.

When the sixth round was completed, preparations began to be made for the exceptional conditions of the seventh and final round, during which all the inhabitants, and much of the substance of the Moon Chain were to be transferred to the succeeding chain, that of the Earth.

CHAPTER XXIV

THE MOON CHAIN: SEVENTH ROUND

THE seventh round of a chain differs from the preceding rounds in that, as the stream of life vacates any given globe and passes on to the next globe in order, the vacated globe passes into quiescence on the way to disintegration.

Further, some of the inhabitants of each globe, being incapable of further evolution on the chain, pass away from the chain altogether, and await re-embodiment in the next chain. The remainder, of course, go on to the next globe in order.

The orange-hued group, numbering rather more than two million, leaves Globe A (higher mental) in this manner (*vide* Diagram XXXV). They have so shut themselves in their mental shell, and have so starved the germs of their astral bodies, that they cannot safely descend further; moreover, they are far too proud to wish to do so.

Their causal bodies are a rigid shell, not a living expanding form, and to allow them to pass on to Globe B (lower mental) would mean a fatal hardening of the lower mental principle. They are, as we have seen, very clever, but quite selfish.

The Manu is clearly dissatisfied with these orange-hued people, and does His best for them by shipping them off out of the chain. Later, we shall meet some of them again in Atlantis, as Lords of the Dark Face, priests of the Dark Worship, leaders against the White Emperor, and so on. For the present they remain in the inter-chain realm. There are also some other entities, who had attained the Arhat level, who left the Moon Chain from Globe A.

The yellow group, rather less than two million, together with the remainder of the inhabitants, passed on to Globe B (lower mental); with them were some who had reached the Arhat level - the level appointed for the chain - on Globe A; these became Adepts on Globe B.

The entities of the yellow group were shipped off from Globe B, because they had not sufficiently nourished the emotional side of their natures to make the formation of a fairly developed astral body possible for them on Globe C (astral). Their willingness to obey stands them in good stead, so that in Atlantis we shall find them as priests of the White Temples, gradually forming astral bodies of a good type.

We shall see later that both the orange and the yellow groups enter the Earth Chain in its fourth round, being too far advanced to take part in the earlier rounds. The principle seems to be that in each globe it is necessary to develop the qualities which will need for their full expression the material of the next globe.

There was another group of entities, who had attained the Arhat level, who left the Moon Chain from Globe B.

Coming to Globe C (astral), once more a small number, who had reached the Arhat level, left the chain, by one or other of the usual Seven Paths. One group of these is of especial interest to us because they formed part of one division of the Lords of the Moon, the group called Barhishad Pitris in *The Secret Doctrine*; they were engaged in superintending the evolution of forms in the Earth Chain. This group had individualised in the fourth round, among a city population where, being surrounded by more advanced people, they had been stimulated into more rapid growth. On leaving Globe C, they went towards the region where the Earth Chain was already building, where they were later joined by others who also gave themselves to this class of work.

On Globe D (the Moon) things became very different; for, when the period for the death of the globe was approaching, the immense majority of the inhabitants, and most of the animals, left the chain and passed into the lunar Nirvana, to await transference to the Earth Chain, when this could be made ready for them. A very small population was thus left to continue its evolution on the three remaining globes - E, F and G.

The group of egos that we have been specially following, known as the group of Servers (*vide* Diagram XXXIV), shows marks of distinct improvement on Globe D. The causal body is well marked, the intelligence more developed, and affection for their superiors has deepened and intensified. Instead of a passion, it has now become a settled emotion, and is their most distinguished characteristic.

Although the instinct of service is still blind and half-conscious, yet to serve and to please the higher people to whom they have devoted themselves is now the dominating motive of their lives. In the future, this remains their characteristic through the long series of incarnations that awaits them on the Earth Chain, when they will do much pioneer work.

Their physical bodies are now bright blue, instead of muddy brown, as before. During their last incarnations on the Moon they are brought together, much arranging having been going on for a considerable time before this. By guiding them to re-birth in communities, the ties between groups of egos are strengthened. Thus they become ready to do whatever they are told, and to go whithersoever they are sent.

They are distinguished by a slight downpour of the higher life, which causes a little expansion of a thread of buddhic matter, connecting the buddhic and the mental permanent atoms, making it a little broader above than below, like a small narrow funnel.

Large numbers of other people, far more intelligent than they are, do not show this, for it is connected with the germinal desire to serve, absent in those otherwise more advanced people.

The group contains many types, by no means only those on one Ray. They individualised by one or other of the three "right" ways, either Will, Wisdom or Activity having been stimulated by devotion to a superior.

The method of individualisation causes merely a sub-division

within the main group, affects the length of the interval between death and re-birth (*vide The Causal Body*, p. 84), but does not otherwise affect the characteristic of serviceableness.

At the head of the group of Servers stand many who have now become Masters: high above them are many who were already Arhats, who again receive their orders from far mightier Beings. The Manu of the seventh Root-Race is in charge, carrying out the instructions of the Seed-Manu.

The Servers, as they die for the last time on the Moon Chain, having reached the level required on Globe D, are gathered on the mental plane, in devachan, where they remain for an enormous time, having always before them the images of those they love, notably of the more advanced egos to whom they are especially devoted. This rapt devotion greatly helps their development, bringing out their higher qualities, so that later they are more receptive of the influences which play upon them in the inter-chain realm.

They are included in the general mass of egos called by H. P. Blavatsky "Solar Pitris" and by A. P. Sinnett "First-Class Pitris."

The two groups we mentioned before may be especially noted. One included Mars and Mercury, the future Manu and Bodhisattva of the Sixth Root-Race on the Earth, others who are now Chohans and Masters, together with many of the Servers who are now pupils of Masters, or approaching that level. These seem to belong to the sub-group with the 700 years average interval between lives.

The other group included many who are now Masters and pupils, all belonging to the sub-group with the 1,200 years average interval between incarnations.

These two groups contained many, if not all, of those who are to form the Heavenly Man.

In the next chapter we shall deal more in detail with the classes of egos who left Globe D of the Moon Chain, arranging them in tabular form, according to grades.

Some of those with primitive causal bodies of the "line" type pass on to Globe E (astral) for further evolution, and become "basket-works," thus joining the class which was above them.

Similarly, some basket-works pass on to Globes E, F and G, and there form the complete causal body, so joining the class above their own.

Globes E, F and G seem to have been used as a kind of forcing-house for special cultures, for enabling some to reach the Path, or to attain Arhatship, who, though near it, could not accomplish it on Globe D, and to enable some, who were approaching a higher stage, to enter it.

These planets were centres more than globes. Their population was small, as we have seen, since the bulk of the inhabitants, both human and animal, had been shipped off to the inter-chain realm. Their number was further progressively diminished by sending off batches from each globe as it passed into quiescence.

Those who were shipped off from Globe E consisted of some already on the Path who had there become Arhats, some basket-works who had completed the causal body, and some "lines" who had become basket-works.

When these had left Globe E; the remainder, consisting of those below the Arhat level who could bear the strain of further forcing, were carried on to Globe F (lower mental). Amongst these were the great entities who later became the Lord Gautama Buddha, and the Lord Maitreya. They had dropped out of the seventh round of the second chain, not being able to bear the forcing process on Globes E, F and G of that chain. They entered the Moon Chain on Globe D in the fourth round as primitive men, and on Globe F took their vow to become Buddhas.

The arrangements then, however, were not the same as on the Earth. There was a kind of Heavenly Council in a heavenly world—the Buddhist Sukhâvati—and the great Being to whom they made their vow and who, as the acting Buddha, accepted it, was He who is called Dîpânkara, who came from the fourth chain of the Venus Scheme, and who was one of the General Staff.

On Globe G the Lord Buddha and the Lord Maitreya passed the First Initiation and also reached Arhatship. On Globe G also the Master Jupiter, among others, entered the Path.

Many of the facts mentioned in this chapter are included in Diagram XXXIV.

CHAPTER XXV

PRODUCTS OF THE MOON CHAIN

IT is now desirable to gather up the results of the three preceding chapters, which dealt with the seven rounds of the Moon Chain, adding many further particulars, and arranging in various ways the numerous classes of entities which emerged from the evolution on the Third or Moon Chain.

To assist the student, we shall make use of some tabular statements and also a few diagrams.

We will first describe the main classes of entities who emerged from the Moon Chain, and then proceed to detail their sub-divisions and ramifications.

In tabular form the main classes were as follows:

The full successes of the chain - Arhats.

Moon-Men of the First Order; sub-divided into five grades.

Moon-Men of the Second Order (basket-work causal bodies).

Moon Animal-Men (line causal bodies).

Moon-Animals of the First Class.

Moon-Animals of the Second Class.

Moon-Animals of the Third Class.

Moon Vegetables.

Moon Minerals.

Moon Elemental Kingdoms III, II and I.

We will now consider these main classes in detail, with

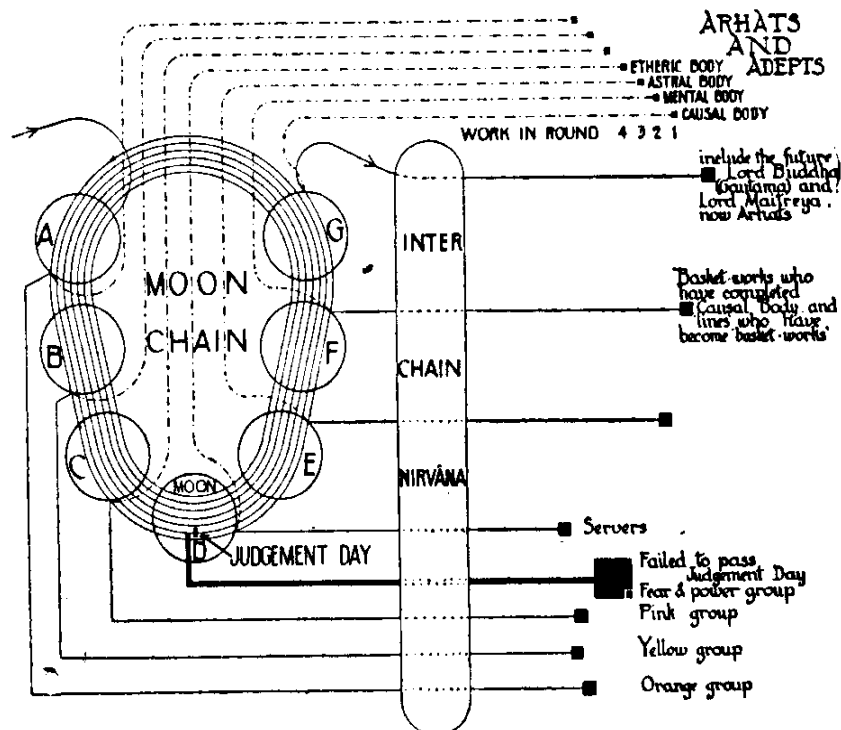

DIAGRAM XXXV.—Emergence of Certain Groups of the Moon Chain.

their various sub-divisions.

Arhats. It will be recollected that the level set for human attainment on the Moon Chain was the Arhat Initiation. Those who reached this level were therefore the "full successes" of the chain, for they had achieved the purpose of the Logos. Having so succeeded, they were free to take one or other of the Seven Paths which always open before the perfected humanity of each chain.

It is not known for certain whether these Seven Paths are the same as those which open before the Adepts of the present (Earth) chain, but at least one of them shows decided resemblance. For just as some of the Earth Adepts will remain in close touch with the succeeding chain (the fifth), and incarnate in it in order to help its inhabitants in their evolution, so one of the seven classes of the Arhats from the Moon, or Lords of the Moon as they are often called, stayed to help on the Earth Chain. The members of this class are those called in *The Secret Doctrine* the Barhishads, or Barhishad Pitris.

They are known also as "Sons of Twilight" celestial men, Sons of the Moon, Progenitors. Another name is the Cubes, because on the Moon Chain they conquered matter in its quaternary or four-fold form, and they brought that matter with them for its further evolution in the Earth Chain.

There are 4 classes of the Barhishad, Lunar, or Rûpa . Pitris, as they are variously called. The first, from Globe G, has the causal body as its lowest vehicle, and presides over the first round of the Earth Chain (*vide* Diagram XXXV).

The second class has the mental body for its vehicle and works in the second round of the Earth Chain.

The third uses the astral body, working in the third round of the Earth Chain.

The fourth is clothed in the etheric double and presides over the fourth round of the Earth Chain.

In addition, each of the 4 classes has 7 sub-classes, arûpa and rûpa, distinguished by difference in evolution; there are thus 28 sub-classes of the Barhishads, 7 working in each round of the Earth Chain.

These are sometimes known as the "seven classes of Pitris"; they must not, of course, be confused with another seven-fold classification, which includes the Barhishads, the Agnishvâttas, and others.

The Barhishad Pitris belong to the Seventh Creative Hierarchy (*vide The Causal Body*, p. 44), and have under them vast hosts of nature-spirits, who are the actual builders of forms, the Pitris themselves being more analogous to architects, giving the plans or models which are worked out by their subordinates.

Moon-Men of the First Order. Below the preceding class comes a large and diversified group known as Moon-Men of the First Order. It includes:

- (1) Some who were on the lower steps of the Path, though below the Arhat level;
- (2) Some who had not yet reached the Path, but, were approaching it;

(3) The "failures", who had dropped out of the lunar humanity at the great Separation, or Day of Judgement, in the middle of the sixth round, together with the most advanced lunar animals, who had succeeded in fully forming the causal body, having individualised in the fifth, sixth and seven rounds.

We can now add some further particulars regarding these classes of Moon-Men of the First Order.

(1) Those who were already on the Path have, like the Lords of the Moon, long ago attained Adeptship and passed away altogether from the field of our consideration.

(2) Those who were approaching the Path had individualised in the fourth round of the Moon Chain. These also have by this time attained Adeptship, or gone still further. Among them are the present Chohans Morya and Kûthûmi (Mars and Mercury), the future Manu and Bodhisattva of the sixth Root-Race on the Earth. Among them also were most of those who became Arhats under the influence of the preaching of the Lord Buddha.

(3) The next class-consisting of the "failures" and the animals who had attained a fully-formed causal body—we may divide into three sub-classes, according to the round in which they individualised. One sub-class individualised in the fifth round of the Moon Chain. They are now the most advanced of our present humanity, the really distinguished people, whether the world accepts them as such or not. They are now either on the Path or approaching it, or they are great saints or men of specially high intellectual or artistic achievement.

(4) The next sub-class individualised in the sixth round of the Moon Chain. This is a fairly large group of people, distinctly gentlemen, persons of refined feeling, with a high sense of honour, and rather above the average in their goodness, intellect, or religious feelings. Typical examples are country gentlemen and professional men, clergy, officers in the army and navy, etc.

They have strength, but are by no means free from the possibility of using their power wrongly. They may not always be considered "respectable," in the conventional sense of that term, but at least they will do nothing low or mean.

(5) The next sub-class individualised in the seventh round of the Moon Chain. The members of this group do not differ greatly from those of the preceding sub-class, except that they are somewhat nearer the average in goodness or intellectual development or religious feeling. They turn their intelligence to rather more material ends, perhaps as city merchants. They represent what is commonly known as the upper middle class - gentlemen still, yet with a life slightly less elevated than that of the professional man.

All these sub-divisions of the first order of moon-men melt into one another by almost indistinguishable gradations, so that the lowest ego of any one of them differs but little from the highest ego of the next class below. Not only are the lines between them thus not clearly marked, but there is even a good deal of inter-penetration. Egos belonging by right to the

mercantile class get astray among the professions, while those of the higher type find themselves forced into business. As they say in India: "In these days castes are mixed."

It will be noted that the divisions are made according to the round of the Moon Chain in which they became human. When that happens in any of the earlier rounds it usually means that the newly-formed ego proceeds to take human incarnations in the next following round. For example, those who individualised in the fourth round came into human incarnation in the middle of the fifth round, and continued to incarnate through the remainder of the fifth, the whole of the sixth, and half of the seventh.

Those who individualised in the fifth round commenced their series of human incarnations in the middle of the sixth; those individualised in the sixth round had their first experience of human life on the Earth Chain, and of course had to be correspondingly primitive when they arrived on that chain.

Moon-Men of the Second Order. This class, having individualised at a somewhat earlier stage of their animal life, had not yet fully developed a causal body, but had what may be described as a skeleton of that vehicle, a number of interlacing streams of force which indicated the outline of the ovoid that was yet to come. Hence they are known as the Basket-Works.

They are represented now by the great mass of the *bourgeoisie* - the lower middle class, a typical specimen of whom would be the small shopkeeper or shop-assistant. They may be described as on the whole well-intentioned; but usually narrow, conventional and dull. They often make a fetish of what they call respectability. A man who is deadly respectable usually does nothing whatever that counts, either for good or for ill. He may go on at a dead level of monotony for many lives, guiding himself always by the canon of what he supposes other people will think of him.

Since people of this level cannot learn the lesson of any particular sub-race as rapidly as the higher classes, they usually take many incarnations in each before passing on to the next.

Moon Animal-Men. These egos individualised from the earliest stage of the animal kingdom at which individualisation was possible. Consequently they commenced their human life without anything which could properly be called a causal body, but with the Monad floating above a personality to which it was linked only by certain threads of âtmic matter. Hence their name of "lines," because their causal body consisted of these lines or threads.

They represent to-day what are usually called the "working-classes," who make the enormous majority of humanity in every country. They are the skilled workmen of the world, belonging to the proletariat, but representing the best class of it; men of determination and good character, self-respecting and reliable.

First-class Moon-Animals. These individualised in the second round of the *Earth Chain*, and are at the present day represented by the vast mass of unskilled labour, on the whole well-meaning,

but, usually careless and improvident. With them may be grouped the higher types of savages, such as the Zulus and some of the better kinds of American Indians and negroes.

Second-class Moon-Animals. This is a lower type, which individualised in the third round of the Earth Chain. They are now savages of comparatively mild type, in some of the hill-tribes of India, and among Western nations in the wastrels, the unemployables, the drunkards and many of the slum-dwellers of the large cities.

Third-class Moon-Animals. These individualised in the fourth round of the Earth Chain, either on one of the earlier globes or even on the Earth itself. They are the lowest specimens of humanity, but little removed from the animal kingdom, being represented now by the lowest and most brutal of savages, and among Western nations by habitual criminals, wife- and child-beaters, and the like. To this group may be added also a few of those who individualised through hatred or fear.

Moon Vegetables. These are now our animal kingdom.

Moon Minerals. These are now our vegetable kingdom.

Moon Elemental Kingdoms, III II and I. These have all moved on one stage in the Earth Chain, so that Elemental Kingdom III is now our mineral kingdom; Elemental Kingdom II is now our Number III; Elemental Kingdom I is now our Number II.

Our Elemental Kingdom I was of course formed by a fresh Life-Stream from the Logos, in accordance with the usual plan.

GROUP	LEAVE MOON CHAIN AS	ENTER EARTH CHAIN AND BECOME IN ROUND				PRESENT CONDITION
		1	2	3	4	
HUMAN	LORDS OF THE MOON ARHATS					BARHISHAD PITRIS
	MOON MEN					THE SEVEN PATHS ON OR NEAR PATH PROFESSIONAL MEN ETC UPPER MIDDLE CLASSES
ANIMAL	MOON ANIMAL-MEN (Lines)					SKILLED WORKERS
	MOON ANIMALS					UNSKILLED LABOURERS UNEMPLOYABLES HABITUAL CRIMINALS ETC
VEGETABLE & MINERAL	MOON VEGETABLES					ANIMALS VEGETABLES
	MOON MINERALS					MINERALS
	MOON ELEMENTAL III					ELEMENTAL KINGDOM III
	MOON ELEMENTAL II					ELEMENTAL KINGDOM II
	MOON ELEMENTAL I From outside					ELEMENTAL KINGDOM I

DIAGRAM XXXVI.—Products of the Moon Chain.

These results are tabulated in Chart I on p. 125. They are indicated graphically also in Diagram XXXVI.

Chart II sets out details of the progress of the most advanced of present humanity and super-humanity, as explained in the three chapters on the seven rounds of the Moon Chain, and as partially illustrated in Diagram XXXIV.

It is obvious that it would be possible to classify these large groups of entities, such, for example, as the Moon-Men of the First Order, in many different ways, because of the fact that the various grades overlap and merge imperceptibly into one another. The following is another classification of the Moon-Men of the First Order, those who had fully-formed causal bodies.

(1) A large group of highly developed egos approaching the Path, but not near enough to it to reach it within the life of the Moon Chain. They are on the line of service, but too far ahead of group (2) to be classed with it.

(2) The Servers, a very mixed group of many grades united by the common characteristic of the desire to serve.

(3) A huge group of very good people, but without the desire to serve, and therefore not turned towards the Path. They will form the bulk of the population of Atlantis-Earth Chain, fourth round; fourth Root-Race-during its good period.

(4) A small but striking group of egos, united by the common characteristic of highly developed intellectual power: future geniuses; varied as to character and morals, destined to leadership in the future, but not dedicating themselves to service nor turning their faces to the Path.

(5) A very large group of good, and often religious people: merchants, soldiers, etc., fairly clever, self-centred, thinking mainly of their own development and advancement, knowing nothing of the Path, and therefore having no wish to enter it.

(6) Another very large group of bourgeois, common-place, weak people.

(7) Another group, also very large: undeveloped, well-meaning, uneducated folk, the lowest class having fully formed causal bodies.

These groups overlap to some extent, and therefore cannot be made to correspond completely with the classification previously given.

In the series of articles mentioned in Chapter XIII, Mr. G. E. Sutcliffe points out that all of the above groups are accounted for except the first—the highest grade. The *less* advanced Servers joined the earth chain in the fourth Root-Race; it seems probable that the *more* advanced group will join the chain in the fifth Root-Race, and will help to bring that Race to its *spiritual* zenith: not, be it noted, its *intellectual* zenith, for that is the task allotted to group (4). This is perhaps the "new progeny" spoken of by H. P. Blavatsky as descending "from the celestial realms" (*The Secret Doctrine*, III, 346-347). Mr. Sutcliffe calculates that the next period of incarnation of this group is due to reach its zenith in A.D. 2.000, and states that the present time should show signs of it, such signs being

already abundantly evident in the new types of people who are appearing in various parts of the world, apparently as the beginning of the sixth sub-race of the fifth Root-Race (*vide* Chapter LIII). For further points of interest on this matter the student is referred to Mr. Sutcliffe's exceedingly interesting articles.

There is, however, one point of special significance at the present time to which attention may be called. A characteristic of the higher grade of Servers is that of following "The Lamb," the World-Teacher, wherever He goes. The Servers of the lower grade, however, follow more especially the World-Teacher-to-be of the Sixth Root-Race; they left the Moon Chain with him and have repeatedly incarnated with him since.

Another student has suggested that, as Group I has been for so long out of incarnation, while Group II has had many trying incarnations" such as those in Atlantis, it may well be that Group II has now "caught up" to Group I in development, so that a little later on the whole group of Servers may be able to work side by side, building the Sixth Root-Race, without any too great disparity in their respective levels of development.

All the above classes are, as said, first-class Pitris, having full causal bodies. Below them comes the immense class of second-class Pitris; with basket-work causal bodies. When the Moon approaches dissolution, they fall asleep in the astral world, being unable to function therein. When Globe E becomes uninhabitable, they lose their astral bodies, and remain inward-turned, to be in due course shipped off to the inter-chain sphere, to sleep until the third round of the Earth Chain offers a suitable field for their growth, as we shall see in due course. Some basket-works of course pass on to the higher globes of the Moon Chain and succeed in forming a full causal body, so that they can then join the class above and become first-class Pitris. Below them again come the third-class Pitris, having "line;, causal bodies. They sleep away the inter-chain period and enter the Earth Chain in the first round. Some of them, however, continue a little longer on the Moon Chain, passing to Globe E, where they become basket-works and so join the class which was above them.

CHART I.—PRODUCTS OF THE MOON CHAIN

Group.	Name.	Individualised in Round.	First human incarnation in Round.	Characteristics on leaving Moon Chain.	Entered Earth Chain in Round.	Became on Earth.	Present Position.	Older Nomenclatures.	
								H.P.B.	A.P.S.
Super-human.	Lords of the Moon.	Moon Chain.		Arbats.		Barhisbad Pitris.	The Seven Paths.		
HUMAN	Moon-Men, First Order.	4 5 6 7	5 6 7 Earth Chain	(1) Fully formed (2) On Path Approaching Path (3) (4) Causal (5) Body.	4 Root-Race 4	Adepts. Adepts. In Round 4, Races 4 & 5. Races 3, 4 & 5.	The Seven Paths. The Seven Paths (1). On or near Path, Saints, etc. (2). Professional Men, etc. Upper Middle Classes.	Nirvānis or Solar Pitris or Lunar Dhyānis.	1st class Pitris.
	Moon-Men, Second Order.			Basket-work Causal Body.	3	In Round 4, Races 3, 4 and 5.	Lower Middle Class.		2nd class Pitris.
ANIMAL	Moon Animal-Men.			Line Causal Body.	1	Fully human Round 1.	Skilled Workers.	1st class Pitris.	3rd class Pitris.
	1st class Moon-Animals. 2nd class Moon-Animals. 3rd class Moon-Animals.	Earth Chain 2 3 4		Passion-nature : dawn of reason. Passion-nature : instinctual mind. Passion-nature germinal.	1 1 1	Fully human Round 2. Fully human Round 3. Fully human Round 4.	Unskilled Labourers. Unemployables, etc. Habitual Criminals, etc. (3).	2nd class Pitris. 3rd class Pitris. 4th class Pitris.	4th class Pitris. 5th class Pitris. 6th & 7th class Pitris.
VEGETABLE	Moon-Vegetables.			Passional nature. Approaching differentiation.	1	Fully animal Round 4.	Animals.	5th class Pitris.	
MINERAL	Moon-Minerals.			Chemical affinity.	1	Fully vegetable Round 4.	Vegetables.	6th class Pitris.	
ELEMENTAL	Moon Elemental Kingdom III.			Tendency to density.	1	Fully mineral Round 4.	Minerals.	7th class Pitris.	Not Classified.
	Moon Elemental Kingdom II.				1	Elemental Kingdom III.	Elemental Kingdom III.		
	Moon Elemental Kingdom I.				1	Elemental Kingdom II.	Elemental Kingdom II.		
	New Life-Stream from Logos.				1	Elemental Kingdom I.	Elemental Kingdom I.		

(1) Includes Chohans Morya and Kūthūmī.
 (2) Includes the Servers.
 (3) Includes a few of those who individualised through hatred or fear.

CHART II.—PROGRESS IN MOON CHAIN OF THE MOST ADVANCED OF PRESENT HUMANITY.

Chain.	Round.	Globe.	Plane.	Present Adepts, etc.	Most Advanced of Present Humanity.
I II III	— — 4	— — D	— — Ph.	Animals Men Monkey-like animals <u>INDIVIDUALISE</u> Develop astral bodies Develop mental bodies Causal bodies primitive	Minerals. Vegetables. Animals: advanced ones mammals. Sleep. Sleep. Sleep.
	5	A.B.C. D	H.M.:L.M. As. Ph.	? Men: some primitive, some civilised: include Lord Gautama Buddha, Lord Maitreya, Mars (now Chohan Morya), Mercury (now Chohan Kūthūmi).	Sleep. Monkey-like animals: domesticated in Fourth Race (include Heracles, Sirius, Aleyone, Mizar, etc.). <u>I N D I V I D U A L I S E</u> THE MAJORITY SERVERS ORANGE GROUP YELLOW GROUP FEAR AND POWER GROUP Float in atmosphere of globe: slight consolidation and improvement of astral body. " " " " " mental " " " " " " causal "
	6	A B C D	H.M. L.M. As Ph.	" " " " " " " " " " " "	" " " " " " " " " " " "
		E F G	As. L.M. H.M.	" " " " " " " " "	" " " " " " " " "
	6	A B C D	H.M. L.M. As Ph.	" " " " " " " " " " " "	" " " " " " " " " " " "
		E F G	As. L.M. H.M.	" " " " " " " " "	" " " " " " " " "
	7	A B C D E F G	H.M. L.M. As. Ph. As. L.M. H.M.	Some become Arhats and leave. Some become Arhats: some Adepts, and leave. A few Arhats leave (A). Some leave Chain, including Arhats. " " " " " " " " Remdr. leave Chain (a). Gautama Buddha and Lord Maitreya reach First Initiation, and become Arhats.	Continue evolution. " " Continue evolution. Distinct improvement. MOST LEAVE CHAIN Others leave Chain, including most "lines" and "basket-works." Others leave Chain: some "lines" become "basket-works": some "basket-works" get full causal bodies. Remainder leave Chain.
				(A) Go to place where Globe A of Earth Chain is building. (B) Join (A), and give their Chhāyās.	LEAVE CHAIN. ? LEAVE CHAIN. LEAVE CHAIN. LEAVE CHAIN.
					Become "Lords of the Dark Face," etc., in Atlantis — IV Chain, 4th Round, 4th Race. Become priests of the White Temples in Atlantis.

CHAPTER XXVI

THE BUILDING OF THE EARTH CHAIN

WE come now to consider such few facts as are known of the building of the globes of the fourth or Earth Chain, which is known to the Hindus as the Body of Dawn.

These globes consist of 2 lower mental globes, 2 astral globes, and 3 physical globes, namely, Mercury (C), the Earth (D) and Mars (E).

It will, however, be recollected that the globes of the Earth Chain, in the first round, were on the same levels as the globes of the Moon Chain in the seventh round. It was only in the second round that the globes descended one plane in materiality. This will be explained further in the next chapter.

As in other cycles, to which reference has previously been made, the building of one chain overlaps the disintegration of the preceding chain, *i.e.*, the new chain commences to build before the old chain has completely broken up and disappeared. Thus Globe A of the Earth Chain began to form as soon as the life-stream left Globe A of the Moon Chain in the seventh round.

Each globe may be regarded as an incarnation of an entity known as the Spirit of the globe. He probably belongs to a class of Deva, members of which class perform the work of building globes all through the System.

Through the intermediary of such a Deva, a great wave of life from the Logos builds up atoms in a System; then molecules are built, then cells, and so on.

When the life of Globe A of the Moon Chain was ended, the Spirit of the globe, as it were, transfers the life within himself to the site of Globe A of the Earth Chain; the Spirit of the globe thus enters on a new incarnation, moving towards a lower grade of matter, and the new globe begins to form round him.

The inhabitants of the deceased globe, or of the dying chain, have, of course, to wait until the new globes are prepared for them. These living creatures are like parasites on the surface of the Spirit of the globe and, in the case of the Earth, for example, the Spirit of the Earth does not concern himself with them, being probably not normally conscious of their existence, though he may feel them slightly when they make very deep mines.

It will be recollected that from Globe C of the Moon Chain, in the seventh round, a small group of Arhats came to help in the preparation of the new chain. They came to the region where the new Globe A was forming; with them were also other Arhats from Globes A and B. The life on Globe A commenced with the First Elemental Kingdom, which flowed upward from the middle of the globe, sometimes called the workshop of the Third Logos, much as water wells up in an artesian boring and flows over the edge on

all sides. It came from the heart of the Lotus, as sap comes up into a leaf.

This group of Arhats, Barhishads, or Lords of the Moon, as they are variously called, took no active part at this stage, but seemed to be looking on at the building of the new world.

Eons later they were joined by another band of Barhishads from Globe G of the Moon chain, and it was these who made the original forms on Globe A, giving their Chhâyâs, or Shadows, to make these, as *The Secret Doctrine* phrases the process. Then the entities Game and occupied the forms thus made.

The more advanced Barhishads, from Globes A, B and C, appear to have superintended the detailed work of the building of the various globes, without themselves actually taking part in it.

The lowest class of Barhishads, from Globe G, having nothing below the causal body, made the primitive archetypal forms on Globe A of the Earth Chain in the first round, and guided the "lines," who came in to fill them and to evolve therein.

The next class, from Globe F, working in the mental body, superintended the evolution of forms in the second round.

The third class, from Globe E, working in the astral body, performed a similar function in the third round.

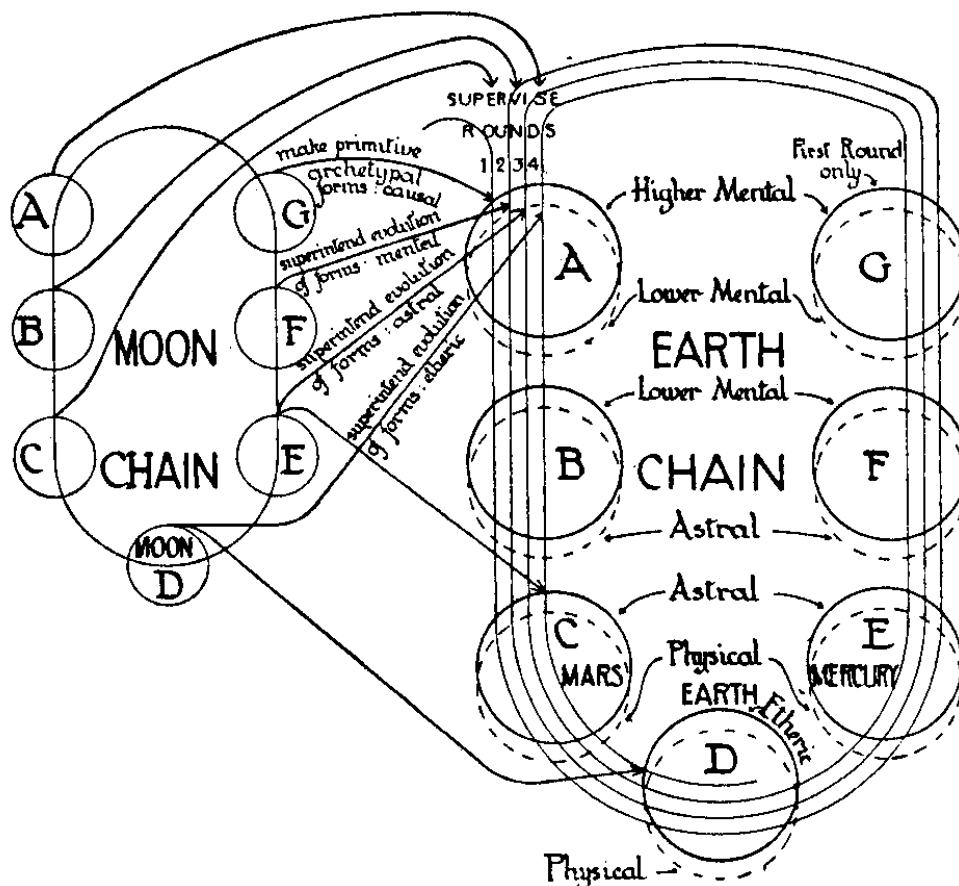

DIAGRAM XXXVII.—The Work of the Barhishads in the Earth Chain.

The fourth class, from Globe D (the Moon), carried out similar duties in the fourth round.

In addition, some of the Lords from Globe E worked on Mars in the fourth round, while those from Globe D (the Moon) became active later on the Earth in the fourth round.

To assist the memory, Diagram XXXVII is appended.

Globes B and C (an astral globe and Mercury) were similarly built up round their respective Spirits, as these left the corresponding globes of the Moon Chain.

The Earth was formed when the inhabitants left the Moon. When the Spirit of the Moon left it, the Moon began to disintegrate, a very large part of its substance passing over to build up the Earth, as we saw in Chapter VI. When the inhabitants left the Moon in the seventh round, Globes A, B and C of the Earth Chain were already formed, but the Earth itself could not go far in its formation until the Moon had been vacated by its Spirit.

We may add here a little further information regarding the Spirit of the Earth. This has been deferred until now in order not to break the continuity of our description of the building of the Earth Chain.

The Earth itself is living, being, as stated, used as a physical body by a vast entity, who is not highly developed, but rather something which may be imagined as a kind of gigantic nature-spirit, for whom the existence of our Earth is one incarnation. His previous incarnation was naturally in the Moon, that being, as we know, the fourth planet of the preceding chain; his next incarnation will be in the fourth planet of the chain which will succeed the Earth Chain. Of his nature or the character of his evolution we can know little, nor does it in any way concern us, for we are, as just stated, but as tiny microbes or parasites upon his body, who can do nothing on a scale large enough to affect him.

For him the atmosphere surrounding the Earth must be as a kind of aura, or perhaps rather corresponding to the film of etheric matter which projects slightly beyond the dense physical body of a man. Further, just as any alteration or disturbance in the man affects this film of ether, so must any change of condition in the Spirit of the Earth affect the atmosphere, and consequently what we call the weather. Some such changes must be periodic and regular, like the motions produced in us by breathing, by the action of the heart, or by an even movement such as walking. Others must be irregular and occasional, as would be the changes produced in a man by a sudden start, or by an outburst of emotion. Hence whatever corresponds in the Earth to emotions in a man may well cause chemical changes in the physical body of the Spirit of the Earth and variations of temperature in its immediate surroundings; these will, of course, produce winds; sudden and violent variations will mean storm; chemical changes beneath the surface of the Earth not infrequently cause earthquakes and volcanic eruptions.

It is well known that some people take an actual delight in rain, snow high winds, thunderstorms and the like. It is probable that this is at least partly due to the subtle changes in the

aura of the Spirit of the Earth, with which they are to some extent in sympathy. The effect produced upon people by these various manifestations depends, of course, upon the preponderance in their temperament of certain types of elemental essence which, because of this sympathetic vibration, used to be called by mediæval inquirers earthy, watery, airy or fiery. Hence, to a man who responds most readily to earth influences, the nature of the soil upon which he lives is of primary importance, whereas a man who responds most readily to watery radiations would care little about the soil so long as he had the ocean or a lake within sight and within easy reach.

Every type of rock or soil has its own special variety of influence, and these vary greatly; three factors are at work: the life of the rock, etc., itself; the kind of elemental essence appropriate to its astral counterpart; the kind of nature-spirits which it attracts. Similar considerations apply to the influences which water exerts upon those specially susceptible to its radiations.

CHAPTER XXVII

THE EARTH CHAIN: THE FIRST ROUND

OWING to the fact, mentioned in the preceding chapter, that the globes in the first round were at the same level as those of the Moon Chain in its seventh round, and therefore a grade higher than they are to-day, and have been since the second round, the conditions of life during the first round were different from any that have prevailed since. For not only the matter of the globes but the life itself was also in all cases a stage higher.

Globes A and G, for example, which are now on the *lower* levels of the mental plane, were then the theatre for life belonging to the *higher* levels. The globes themselves were built even then of lower mental matter, but it was not in a condition to be inhabited by beings at its own level; it was not sufficiently condensed, or at rest.

Globes B and F, though composed of astral matter, were then utilised only for forms of lower mental matter.

Globes C and E (Mars and Mercury) were still in a condition largely gaseous and etheric, and only *astral* bodies were employed by the entities who lived upon these two planets.

Our own planet D (the Earth) already contained a good deal of solid physical matter, but in a condition of heat so intense that there were still lakes and seas, and even showers, of molten metal; hence it would have been quite impossible for people with bodies in the slightest degree like ours to live there at all. The inhabitants, however, used only vehicles of *etheric* matter, and therefore were not at all incommoded by these conditions.

In the interval between the First and Second Rounds the matter of the various globes had time to settle down into a more orderly condition, so that each of them could be inhabited in the Second Round by entities using vehicles at the level of its own matter.

The following is a vivid description of the condition of the globes in the first round. "Behold a vast mass of heaving, tossing, whirling, fiery matter, flashing, rolling, changing, in billowing masses, slowly aggregating itself according to three varying densities, into seven filmy forms. Scarce forms indeed can we call them, for even when we descend to the fourth, the most material of the globes" we can catch only a dim glimpse of Earth's first *rûpa* (form), a mere film of *âkâsha*, tenuous, radiant, luminous, fiery. There is nothing visible save embodied fire in this round. Seven of these globes we dimly see, of which the fourth, that is to be our Earth, is the most perceptible. Above it, on the descending arc, vague and vaguer shadows loom through the fiery mists. Above it, on the ascending arc, three other shadows, fiery, scarce perceptible. A vast panorama of flames, that take and lose again the form of globes, huge, wondrous, awe-inspiring, in resistless force and overwhelming

energy."

The worlds are thus curious, like churning whirl-pools; Mars and Mercury are still in a condition largely gaseous and etheric, entities on them living in astral bodies. The Earth, the most solid, is hot, muddy, sticky, and much of its territory does not seem to be anchored down very firmly. It is seething, and constantly changing in consistency; huge cataclysms engulf great multitudes from time to time, and in their embryonic condition- for they are using only etheric bodies-they do not seem very much the worse for their engulfing, but increase and multiply in huge caves and caverns, as though they were living on the surface.

The Earth Chain consisting of new globes, freshly aggregated, there were, of course, at first no forms on them for the incoming entities to inhabit. These forms, therefore, had to be established for all the kingdoms of nature. This needs to be done at the beginning of the first round of a new chain, but never after that; for, as was explained in the chapter on "The Inner Round," there is always left on each globe, even when the main streams of life have passed on to the next globe in order, a small nucleus of entities belonging to each kingdom.

Accordingly, the lowest class of human beings of the Moon Chain come into the Earth Chain at its commencement, and establish the forms in the first round. They are then followed by the next grades of entities in succession, as we shall see in detail in due course.

We may repeat here what was said in Chapter XVII as an example of the work of a Manu. In the first round of the Earth Chain the Manu in charge brought down all the archetypes for the whole of the chain. Although many of these will not be fully perfected down here until the seventh round, yet the germs of all of them were already there in the first round.

For every kingdom in nature He selected a certain set of forms, which He wished to have vivified during the first round, with the view of developing from them at later stages everything which the Logos wished the Earth Chain to produce.

The scheme of these forms, materialised down to a level where they could use them, was handed over to certain of the Lords of the Moon, or Barhishads, who were entrusted with the work of setting the activities of the first chain in motion. The Barhishads from Moon Chain Globe G were in charge of this, the first round of the Earth Chain.

In each of the seven globes of the first round they made these forms, and as they made them the animal-men from the Moon Chain entered them, solidified and used them, and from them generated others which could be inhabited by the moon-animals which occupied the stages below them.

In accordance with the principle, already explained (*vide p.* 102), that the most backward entities are those who incarnate first on a new globe, entering there the primitive forms which have so far been evolved, the Moon Animal-Men, having only "line", causal bodies, came first into the Earth Chain. To them was assigned the pioneer work of the Chain.

With them came also the great mass of animals from Globe D of the Moon Chain. The ship-loads or batches succeeded each other at intervals of about 100,000 years, and then the supply stopped, and an immense period followed" during which the new arrivals were, as said, doing the pioneer work of the chain, during the first and second rounds.

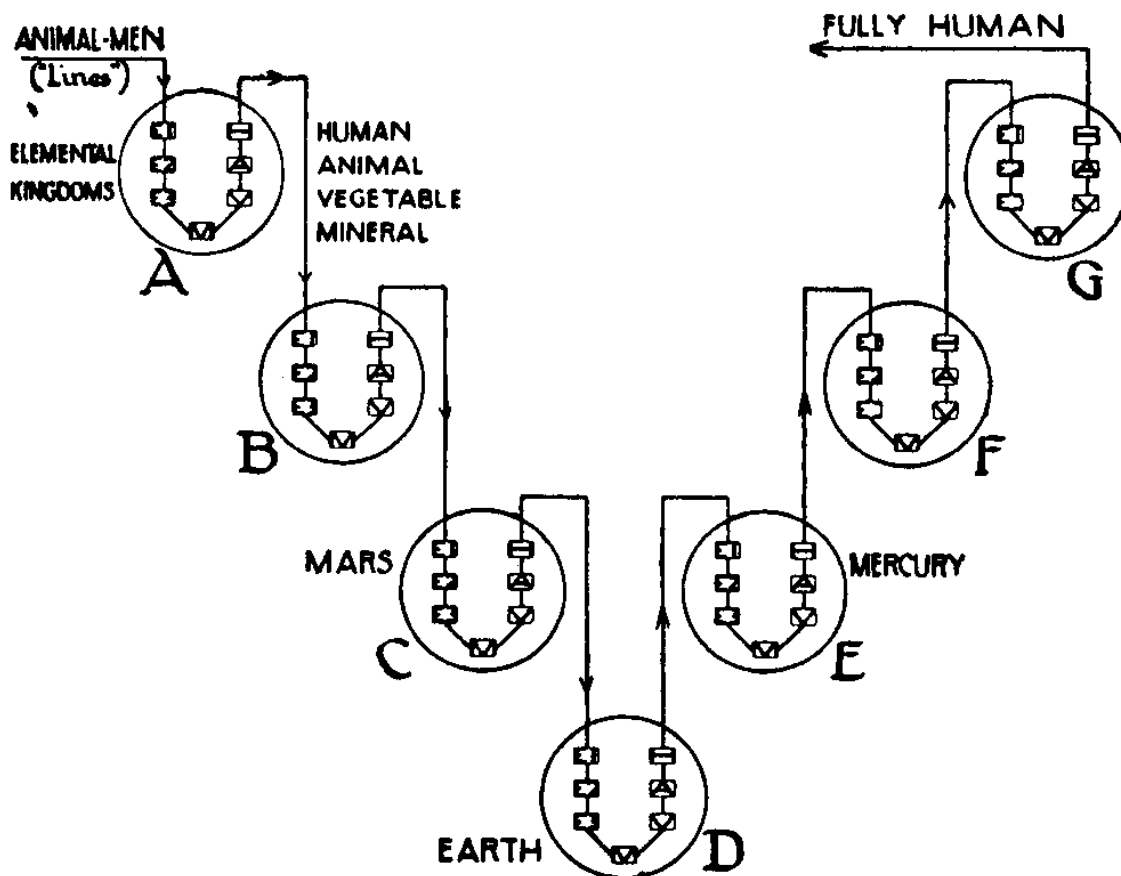

DIAGRAM XXXVIII.—The Earth Chain : First Round.

Their progress possessed this curious feature, that they did not continue their evolution from the point where they had left it on the Moon Chain, but recapitulated all of its stages many times. For on each of the planets of the Earth Chain in the first round they entered the First Elemental Kingdom, passing rapidly through it, and then through the Second and Third Elemental Kingdoms, the mineral, the vegetable, the animal, and eventually reached the human kingdom once again (*vide* Diagram XXXVIII).

In each of the kingdoms they fulfilled the function of establishing the forms, taking the idea of them from the Barhishads directing the evolution of the globe concerned. These primitive entities may, perhaps, rather be considered as flowing into the moulds made by their instructors, and as materialising the moulds for the use of those who followed them.

Having done this on each of the seven planets in the first round, they attained humanity for the last time on the seventh

planet of the Earth Chain in this first round. Since then they have rested from that particular and tedious kind of labour, for in the second round they were human from the beginning. But, although they entered the first globe of the second round at the level of primitive humanity, it was so primitive that the advantage was scarcely a perceptible one.

The evolution, on the various rounds of the Earth Chain, of the forms into which these entities entered, was carried out, as stated, by the Barhishad Pitris. Barhishads from Globe G of the Moon Chain, being the lowest class of Barhishads, made the primitive archetypal forms in the first round of the Earth Chain; those from Globe F of the Moon Chain constructed the forms for the second round of the Earth Chain; those from Moon Chain Globe E built the forms for the Earth Chain third round; whilst the forms for the present fourth round of the Earth Chain were built by Barhishads from Moon Chain Globe D.

Coming now to describe the little that is known of the conditions of the first chain, we find that the man on Globe A (at present higher mental) can hardly be called a man at all: he is a thought. He is what will some day be a mind-body, bearing perhaps the same relation to its later possibilities as the embryonic form of an infant after the first month bears to the fully-developed human body. He has marvellously little consciousness at this early stage.

On Globe B, at this stage lower mental, though in the second round to become astral, everything was fixed definitely at the lower mental level, with a little commencement of astralisation.

On Globe C (Mars) men had definite astral bodies, but they were as yet imperfect, for matter of certain sub-planes only was then to be had. A little touch of etheric matter also was introduced, though only certain kinds of ether were available.

On Globe D (Earth) men had etheric bodies, but they were mere drifting shapeless clouds, though towards the end of the globe-period they began to aggregate round themselves gaseous matter as well as etheric. They appear to have absorbed from the intensely heated atmosphere whatever they required in the way of nutriment.

They seem to have had a succession of manifestations which we may take as corresponding to races: apparently, however, these were only root-races, for there were but seven; and one incarnation, if we can call it an incarnation, for each individual lasted through the whole race. They multiplied by fission.

It appears that the world-periods were then enormously longer than they are now, but still it is not easy for us, with our ideas of what life means, to understand how these most primitive of men could contrive to evolve at all.

In the lower kingdoms, some entities in etheric bodies appeared to be trying, but not very successfully, to be dreams of vegetables.

The etheric bodies of minerals were formed, but these were not whole etheric bodies, because at this early stage only some

of the sub-planes were fully vivified.

Further, the atoms were more sluggish, since, this being the first round, only one set of spirillæ was in activity.

The general condition of the world has already been described, but we may add some further particulars. Minerals were somewhat more solid than they had been on Mercury, for they were largely pelted on to the Earth by the Moon in a molten condition; the temperature might be anything above 3,500° C. (6,332° F.), for copper was in the condition of vapour. Silicon was visible, but most of the substances were proto-elements, not elements, and the present combinations seemed to be very rare. The Earth was surrounded by huge masses of vapour shutting in the heat, and hence cooled very slowly. At the Pole there was some boiling mud, which gradually settled down, and after some thousands of years a green scum appeared, which would become vegetable later on.

By the end of the globe-period the temperature was considerably reduced, perhaps to about 1,000° F. on the average, though it remained much hotter in certain districts, and in others it had got down to the level of boiling water.

On Globe E (Mercury) there were apparently only the three higher ethers—not four as there had been on the Earth. The humanity, however, had obviously progressed, and were much more alive than they had been, though even now their consciousness seemed amoeba-like. Nevertheless, it is clear that man was already beginning in a blind way to work both upwards, to make his vehicles more conscious, and downwards, to densify his lower vehicles.

Primitive though everything was, each globe was certainly an advance on that which preceded it. But in all cases it appears that man had not yet the full consciousness even of any subdivision of matter in which he happened to be working. The impression given rather is that each sub-division was again subdivided, and that he was able to use only this fraction of a part.

Little seems to be known concerning the conditions on Globes F and G (at this stage lower and higher mental respectively), except that there for the first time was observed the phenomenon of "failures," which has previously been mentioned and explained.

It will, of course, be understood that no matter of the lower planes is ever carried over from one globe to another. Only the egos are carried over, and they draw round themselves matter belonging to the new planet and, in the case of physical bodies, obtain these from the baby vehicles provided by the entities who are already living on the new planet.

In the first round, when form appeared for the first time, so far as the Earth Chain is concerned, the human shape was evolved from the animal, precisely as the Darwinian theory suggests. There is, however, an important difference between the Darwinian theory and the teachings of Occultism, because; for the inconceivably slow process of natural selection from accidental variation, Occultism substitutes an intelligent direction, both of the selection and of the variations, holding that the forms

evolve only in order that they may be a fitter expression for the evolving life within.

In the present (fourth) round, however, Occultism is at direct variance with the Darwinian theory, for it teaches, as we shall see later, that the process was reversed, the human form existing on the Earth before those of any of the mammals which we now know.

CHAPTER XXVIII

THE EARTH CHAIN: THE SECOND ROUND

IN the second round the globes descended a stage in materiality, becoming what they are now, viz., 2 lower mental globes, 2 astral and 3 physical.

In this round the temperature of Globe D (the Earth) had dropped considerably, so that copper had become liquid, and in some places solid. There was some land near the Poles, but flames burst out if a hole was made.

The forms made in the first round being already there, it was not necessary to repeat the building process.

In this round man was working at the first and second subdivisions of matter of each sub-plane only, so that, while he had in him matter of all the planes; it was only the two lower subdivisions of the two lower sub-planes that were active.

The races were much more definite, and were clearly distinguishable one from another. Men were no longer mere drifting clouds of etheric or gaseous matter, but had succeeded in developing a certain amount of solidity though they were still unpleasantly jelly-like in consistency and indeterminate in shape. H. P. Blavatsky called them "pudding-bags," because of the curious shapeless projections which they had instead of arms and legs. At the beginning of the round they put out these projections temporarily, just as an amoeba does; but constant repetition of the process at last made the projections permanent, and moulded them into some approximation to the form into which they were destined finally to settle.

Many of these creatures were so light and tenuous that they were able to drift about in the heavy atmosphere of the time. Others rolled along rather than crept, but none of them were able to maintain themselves in an upright position without assistance.

A blow on their bodies made an indentation, which slowly filled up again, like the flesh of a person suffering from dropsy. The fore part of the body had a kind of sucking mouth, through which it drew in food, and it would fasten on another and draw it in, as though sucking an egg through a hole, whereupon the sucked one grew flabby and died.

They had a kind of flap-hand, like the flap of a seal, and they made a cheerful kind of chirruping, trumpeting noise, expressing pleasure; such pleasure was a sort of general sense of well-being, and pain was a massive discomfort, nothing acute, but only faint likes and dislikes.

The skin was sometimes serrated, giving shades of colour. Later on, they became a little less shapeless and more human, and crawled on the ground like caterpillars. Later still, near the North Pole, on the cap of land there, the creatures were developing hands and feet, though unable to stand up, and more intelligence was noticeable.

A Barhishad, from Globe F of the Moon Chain, was observed, who had magnetised an island, and shepherded on to it a flock of the creatures, reminding one of sea-cows or porpoises, though with no formed heads. They were taught to browse, instead of sucking each other, and when they did eat each other they chose some parts in preference to others, as though developing taste.

The depression which served for mouth grew deeper into a kind of funnel, and a stomach began to develop, which was promptly turned inside out if any alien matter which was disapproved of found its way in. One turned himself entirely inside out, and seemed none the worse.

The surface of the Earth being still very uncertain they occasionally got burnt or partially cooked; this they evidently disliked, and if it went too far they collapsed.

Reproduction was by budding: a protuberance appeared, and after a while broke off and led an independent existence.

Man was still lamentably incomplete as regards his higher vehicles. He had what he considered a mind, and something else that might stand for a feeble astral body, but his consciousness was still dim and vague and he had little thinking power: he was all instincts and almost no reason.

After a time the end of the body which contained the funnel tapered off somewhat, and a small centre appeared in it which, in far future ages, might become a brain. A small protuberance appeared, and there was formed the habit of drifting forward, with this in front; as carrying the mouth; impacts being constantly made on it, development was promoted.

In this round the animal-men (line causal bodies) maintained and improved their human position, and by the end of the round the first class of the animals had definitely attained humanity.

Just as all the archetypes of the mineral kingdom had been fully brought down in the first round, though not yet fully worked out, so were all the vegetable archetypes brought down in the second round, though it was long after that before they were all realised.

Vegetable life was aided by the heavy choking atmosphere; there were forest-like growths, much resembling grass, but forty feet high and proportionately thick. They grew in the warm mud, and flourished exceedingly. It is probably chiefly to the vegetation of this period that we owe our coal deposits.

Towards the end of the round, some of the Earth was quite solid and only reasonably warm. There was much tumultuous cracking, apparently due to shrinkage, and every hill was an active volcano.

Mars became more solid, cooling rapidly in consequence of its smaller size, but life on it was much like that on Earth.

The building of the forms in this the second round was in charge of the Barhishads from Globe F of the Moon Chain.

The Moon Chain animal-men, who had rapidly run through all the kingdoms in the first round, entered the first globe in the second round at the level of primitive humanity, and continued their evolution thereon as human beings.

In the course of the second round, the first class of the moon-animals reached the human level.

CHAPTER XXIX

THE EARTH CHAIN: THE THIRD ROUND

IN the third round of the Earth Chain conditions became more comprehensible. Even in the earlier globes man became more human in shape than he had been before, though even then he was still cloudy, gigantic and far from beautiful.

On Globe C (Mars) some animals began to develop, though at first they looked rather like clumsy logs of wood. As time went on, they obtained for the first time in this round what may be called a recognisably human body, though at first it was still etheric, and more like some kind of reptilian monkey than man as we know him now.

He was still somewhat jelly-like, so that if the skin were poked the hole remained for a long time before it filled out again. He had rudimentary bones, but perhaps more gristle than bone. He was not stiff enough to stand, and so he lay grovelling and wallowing in the soft warm mud at the sides of the rivers.

The physical configuration of Mars was very different from that now known to us, for the water scarcity had not yet arisen.

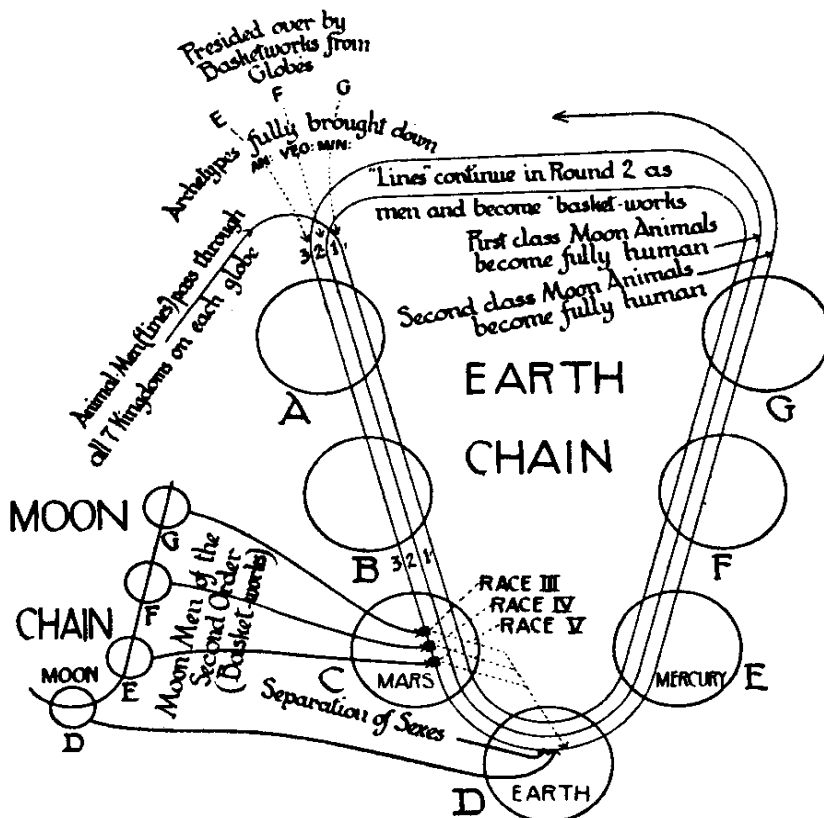

DIAGRAM XXXIX.—The Earth Chain : Rounds I, II and III.

On the contrary, about three-fourths of the surface was water and only one-fourth dry land. Hence there were no canals, as now, and

the general physical condition much resembled that of the Earth to-day.

Much of the country was pretty, though the vegetation was peculiar. The atmosphere was what we should now consider unbreathable, being full of chlorine and quite suffocating.

All the animal archetypes were brought down in this round, though many of them were not worked out until the middle of the present (fourth) round.

The Moon Animal-Men (line causal bodies) had by this time developed basket-work, of a coarser kind than that which had been developed on the Moon. When this stage was reached, Moon Men of the Second Order (basket-works) came streaming in. Also batches were sent off by the Seed Manu to the Earth (*vide* Diagram XXXIX, which represents graphically an epitome of Rounds I, II and III).

A Manu was observed bringing to Mars a batch of basket-works, reminding one of the legends of Noah with his ark, and also of stories in the Hindu Purânas of the Manu crossing the ocean in a ship, bearing with Him seeds for a new world. Arriving on Mars, He founded a colony of His basket-works thereon.

This set of basket-works had come from Globe G of the Moon Chain, and was therefore the least developed of the basket-work class, having been the last to reach that stage.

The Manu guided them to take birth in the most promising third-Race families on Mars, and, as they grew, He led them off to His colony, where they would more quickly develop into fourth-Race people.

In the colony the people moved by a central will, like bees in a hive (*vide The Causal Body*, p. 63), the central will being that of the Manu. He sent out streams of force and directed all.

Another set of basket-works came from Globe F of the Moon Chain, and a third set from Globe E; those from Globe F arrived first, and formed the fourth Race on Mars, those from Globe E formed the Martian fifth Race.

Under the fostering care of the Manu, they developed some affection and some intelligence, at first living in caves, later beginning to build, and even teaching the aborigines to build under them. Thus, at this stage of evolution, even basket-works became leaders.

They were hermaphrodite, but one sex was usually developed more than the other, and two individuals were necessary for reproduction. Among the lower types, other forms of reproduction also existed, and there were some primitive human beings of the hydra kind who reproduced by budding and others by exudation, while some were oviparous. But these were not found among the basket-works.

In the Martian fifth Race the social arrangements changed, as more intelligence was developed. The bee system disappeared, but they still had little individuality, and moved rather in flocks and herds, shepherded by their Manu.

The basket-work became more closely woven, representing what could be done by the unfolding life in those who were

emphatically self-made men, unaided by the great stimulus given in the fourth round by the Lords of the Flame. This type of man is still largely represented among us to-day by the people who hold conventional ideas because others hold them, and are wholly dominated by "Mrs. Grundy." They are often quite good people, but very sheepy and "flocky," and are appallingly monotonous.

There was one fierce type of basket-works which lived, not in communities, but wandering about the forests in pairs. Their heads ran up to a point behind, matching the chin in front, so that the head, ending in two points, looked odd and unattractive. They fought by butting against each other like goats, the top of the head being of very hard bone.

There were some yet lower types, curious reptilian creatures, living in trees. They were larger than the "lines" and far less intelligent, and ate the latter when they had the chance.

There were also on Mars some carnivorous brutes, huge crocodile-like animals who fiercely attacked men.

On the Earth, the third round much resembled that on Mars, the people being smaller and denser, but, from our present standpoint, still huge and gorilla-like. Even from the beginning they were more compact, and began to stand upright, though they were still shaky and uncertain, and always fell back to all-fours when pursued or frightened.

They began to have hair and bristles upon the body, but they were still loose and flabby. Their skins were dark and their faces scarcely human, strangely flattened, with eyes small and set curiously far apart, so that they could see sideways as well as in front.

They had the lower jaw very heavily developed, and practically no forehead, but just a roll of flesh like a sausage where the forehead should have been, the whole head sloping backwards curiously.

The arms were much longer in proportion than ours, and could not be perfectly straightened at the elbows, a difficulty which existed also with the knees.

The hands and feet were enormous and misshapen, and the heels projected backwards almost as much as the toes did forwards, so that the man was able to walk backwards as rapidly and as certainly as in the other direction. This curious form of progress was facilitated by the possession at the back of the head of the third eye, which still remains to us in a rudimentary form as the pineal gland.

Even yet men had scarcely any reason, but only passions and instincts. They knew nothing about fire, were unable to count. They ate chiefly certain slimy creatures of reptilian nature, but they also dug up and ate some kind of primitive truffle, and tore off the tops of gigantic tree-ferns in order to eat the seeds.

Towards the middle of the occupation of the Earth the separation of the sexes took place.

Soon after that the Second Order of Moon Men (basket-works)

from Globe D, the Moon, came into incarnation. After them came the basket-works from Mars, the whole resembling fairly intelligent gorillas. In the first place they were born of the existing humanity, but they soon established a new type for themselves, becoming smaller, more compact, lighter in colour and generally speaking much more what we should now call human in appearance.

There was constant war between them and the earlier and more gigantic inhabitants, who caught and ate them whenever opportunity offered. But the later arrivals, having much more intellect, were presently able to dominate their gigantic congeners, and to keep them in some sort of order. In fact, practically the whole world presently passed into their control, and the earlier races had either to adapt themselves to the more civilised life or to be driven off into the less desirable parts of the country.

The animals were very scaly, and even the creatures we must call birds were covered with scales rather than feathers. They all seemed to be made of a job-lot of fragments stuck together, half-bird, half-reptile, and wholly unattractive.

In this round the second class lunar animals reached the human level.

The Earth was still far from being as quiescent as it is today. Earthquakes and volcanic outbursts were still painfully common, and life was distinctly precarious. The configuration of the land was entirely different, and mountains seem to have attained stupendous heights, unknown to us now. There were enormous waterfalls, and great whirlpools were also common.

Nevertheless it was by this time a little more like our present world than the preceding globes, in fact than anything since we left the Moon. Later on even cities were built.

The work of the Barhishads, the Lords of the Moon, who in this round were Arhats from Globe E of the Moon Chain, resembled the training of animals more than the evolution of a humanity.

They were, as in previous rounds, working on sections of the different bodies, physical and subtle. The third sub-planes of the physical, astral and mental planes were being worked through, but of course only the third sub-divisions of those sub-planes.

The methods of reproduction on the Earth were those which are now confined to the lower kingdoms of nature. In the first and second Races, not thoroughly densified, fission still occurred, but in the third and onwards the methods were various: in the less organised, budding-off like hydræ: the exuding of cells from different organs of the body, which reproduced similar organs, and grew into a miniature duplication of the parent; the laying of eggs, within which the young human being developed. These were hermaphrodite, and gradually one sex predominated, but never sufficiently to represent a definite male and female.

When the race passed on to Globe E (Mercury), there was on the whole a decided improvement. Much more affection appeared, and men showed distinct traces of unselfishness, sharing their food instead of snarling over it as they had frequently done at

the earlier stages.

The presence of the Moon-Men (fully formed causal bodies) had given a great impetus to progress, and though the bulk of humanity were still very animal and undeveloped, traces of co-operation and rudimentary civilisation already began to appear.

Nothing is known of the conditions on Globe F (astral) or on Globe G (lower mental).

CHAPTER XXX

THE FOURTH ROUND: GLOBES A, B and C

THE fourth round is often called the human round because, at its beginning, all the archetypes for every Root Race were brought down and appear on Globe A. From an examination of these archetypes it is possible to see what men of the future will be like. They will have finer vehicles in every way, and will be distinctly more beautiful in appearance, expressing in their forms the spiritual forces.

The student will recollect also that in the fourth round the mineral is destined to reach perfection, *i.e.*, the point of greatest hardness and density. In taking a preliminary bird's-eye view of the fourth round, there are three important characteristics which differentiate it from the preceding rounds; these are:

- (1) The change in the condition of the elemental essence:
- (2) The shutting of the door against the animal kingdom, and the opening of the door to the Path:
- (3) The recapitulation of the first three rounds on the fourth globe (D, the Earth).

We shall deal with the first of these in this chapter, and with the other two in later chapters. On Globe A, in the fourth round, mind became definite on the lower mental level, so that we may say that in this round man began really to think. The result at first was by no means good. In the previous rounds he had not been sufficiently developed to originate thought-forms to any great extent, and consequently the elemental essence of the globes had been affected only by the thoughts of the devas, which left everything harmonious and peaceful. Now that man began to interject his selfish and jarring thoughts, this comfortable condition was very largely disturbed. Strife, unrest and disharmony were introduced: the elementals began to show hostility to man, for, from their standpoint, he was no longer an animal among animals; but an independent and domineering entity, likely to be hostile and aggressive.

Furthermore, the animal kingdom drew decisively apart from man, and began to feel fear and hatred towards him.

When the life-wave reached Globe C (Mars), it found in possession of the planet, besides the ordinary seed-humanity, another and most unpleasant race, which is spoken of in *The Secret Doctrine* as the "water-men, terrible and bad." These were basket-works of a very poor kind, some of those who had individualised through fear and hate.

They were descended from the type which had been left behind in the previous round as unfit to make progress, and since then they had been engaged in developing the evil side of their nature.

They were amphibious, half-reptile, half-ape, scaly creatures, with a horrible tarantula-like appearance about the

eyes, and a fiendish delight in cruelty and evil. They seem also to have had a certain amount of low-class mesmeric power, and were a kind of primitive edition of the Malakurumbas as described by H. P. Blavatsky in her account of the hill tribes of the Nilgiris.

When the life-wave came round, the incoming humanity soon established itself sufficiently strongly to free itself from the fear of these monstrous savages. It was to resist possible attacks from them that the first fortifications were erected by man, and it was also to be able to defeat their malignity that men began first to build primitive cities and live together in considerable numbers. At first they built principally of wood and mud, though sometimes of piles of unhewn stone.

At this period, that of the fourth Race, some of the Lords of the Moon incarnated among men and taught them many things, among others the use of fire, which, however, they did not yet know how to produce for themselves. The greater Beings lighted their fires for them, and then they kept them perpetually alight. Very early a stringent law was made that a public fire should always be kept burning in a building specially dedicated to it, and the young girls who could not as yet either work or fight were usually left to watch it. From this no doubt arose the first idea of a sacred fire, ever to be kept burning as a religious duty, and of the appointment of vestal virgins to guard it.

Sometimes, however, it happened that, from a great flood or tempest or some other catastrophe, a whole district was left for a time without fire, and then the people often had to travel far in order to obtain and carry back to their homes this prime necessity. Some bold spirit conceived the idea of obtaining fire in such an emergency from the crater of a volcano, and many lives were at one time or another lost in attempting to do so.

It was also the Lords of the Moon-Barhishads from Globe E of the Moon Chain-who planned the system of canals, owing to the scarcity of water; the work was executed by the basket-works under Their direction. The Martian seas are not salt, and the polar snow-caps, as they melt, supply the water necessary for irrigation, and thus enable the ground to be cultivated, and crops to be raised.

The fifth Root-race was white, and made considerable progress, the basket-works developing a complete causal body. They were good, well-meaning, and kindly, though not capable of any large ideas, of widely spread feelings of affection, or of self-sacrifice. At a quite early stage they began to divide food instead of fighting over it, developing the social feeling to some extent.

Being thus comparatively advanced, they built their houses of hewn stone, though without mortar. They were proud and warlike, but had some curious ideas. They appear to have had no initiative whatever, and they regarded anything new with horror, as exceedingly immoral and repulsive.

They had no perseverance, and even yet but little reasoning capacity. Everything was done under impulse, and nothing was

under control in any way, so long only as it was nothing new. Yet in many ways they would compare favourably with some races which exist on the Earth now.

The sixth Race people were a much more powerful set, with a considerable amount of will and determination. They soon dominated the fifth Race, taking up its civilisation and carrying it much further. They succeeded in subduing the whole of the planet and brought it under one rule, although the enormous majority of its inhabitants belonged to the fifth Race.

These people had much more mind than the others, and possessed some inventive genius, but it was their tendency to do everything by fits and starts, and not to take up a piece of work and carry it through.

There was some psychic development among them, but it was usually uncontrolled. Want of control, in fact, was a permanent characteristic of this Martian civilisation. Everything was erratic, even though the people were capable in certain ways.

The seventh Race people in turn got the power into their hands, not by force, but rather by superior mental development and cunning. They were not so warlike as the sixth Race, and they were always smaller in number, but they knew more in many ways than the sixth.

They were coming nearer to modern ideas; they had a more definite sense of right and wrong; they were less fierce and more law abiding; they had a definite policy and lived according to it.

Their supremacy was entirely intellectual, and they possessed to a high extent the art of combination. Their social polity seems to have been something like that of ants or bees, and in some ways they would compare favourably with many races of the present.

It was in this Race that writing was first noticed as a fairly common accomplishment. They knew something of art, for they had both statues and pictures, though totally different in every way from ours. They were also the first race that took the trouble to make roads.

CHAPTER XXXI

THE EARTH: THE FIRST ROOT-RACE

WE come now to the occupation of the Earth in the fourth round, and will deal in this chapter with the first Root-Race.

As was mentioned in the preceding chapter, the special and peculiar characteristic of the earlier races on the Earth in this, the fourth round, is that the earlier races recapitulate the first, second and third rounds. This is arranged specially for the benefit of those entities who, though considerably behind the rest, could by a special effort of this kind be helped to overtake them.

The first Race was etheric, repeating the first round: the second Race was of the "pudding-bag" type, repeating the second round: the third Race repeated the third round. The fourth Race may be considered as the most typical of the fourth round as a whole. These general principles will be elaborated and explained more in detail as we come to consider each Race individually.

The Earth, at the beginning of the fourth round, is in a condition of terrible turmoil; there are gigantic convulsions of nature, the crash of falling mountains, the roar of volcanoes, the dash of giant waves loaded with rocks, with avalanches of lava, almost mountains, which they toss up as though in play. Fire is breaking out everywhere, storm, whirlwind and tornado. It recalls the first round in miniature, save that the greater density of matter makes the crash and tumult far greater than when the globes were more subtle in composition.

For 200 millions of years these convulsions go on "uninterruptedly, after which they become periodical and at long intervals" (Commentary, quoted in *The Secret Doctrine*, II, 230).

For 300 millions of years the nature spirits have been busily at work, forming minerals, vegetables and animals of the lower kinds. Out of the remnants of the three preceding rounds they have taken the empty shells of forms and have tried to shape them into new living organisms. The results are strange hybrid monsters of all mixed kinds of generations, half human and half animal. Reptilian forms of all sorts and kinds appear. They may be said to have been produced by the "prentice hand of nature," being the work of the lower Devas, the nature spirits, unassisted by the guiding power of the Lords of the Moon.

When the incessant turmoil is nearing its ending, some of the Lords of the Moon, or Barhishads, come to see if the earth is ready for the making of man. All these lower forms are then swept away, presumably in order to clear the way for man and higher forms of life generally.

At one point, gradually, the first land appears, above the vast ocean of heaving, tepid water. It is the peak of Mount Meru. In some of the earlier literature this was described as the cap of the North Pole. It is, however, understood that it is the cap, not of the geographical, but of the spiritual Pole of the earth.

This is the imperishable Sacred Land—now in the Gobi desert. It has been called also the Land of the Devas, Shvetadvîpa, the White Island, the Central Land, and sometimes Jambudvîpa, the name given to the Earth as a whole.

The Parsis call it Airyana Vaejo, and rightly claim that their great prophet Zarathrustra was born there.

From Mount Meru, the centre of that land, appear seven great promontories, to the edges of which the name Pushkara is sometimes given, though that name belongs more accurately to the seventh continent—which of course has still to appear when the time comes for the seventh Race.

Every human Race is born in this land, no matter: whither it be led after its birth. The climate is described as that of an exquisite spring.

The next stage of the process is described in the Book of the Wisdom thus: The Order has gone forth: "The great Chohans called the Lords of the Moon, of the airy bodies: 'Bring forth men, men of your nature. Give them their forms within. She will build coverings without. Males—Females will they be. Lords of the Flame also.' . . . They went each on his allotted land; seven of them, each on his lot. . . . The Seven Hosts, the Will-born Lords, propelled by the Spirit of Life-giving, separate men from themselves, each on his own zone. Seven times seven shadows of future men were born, each of his own colour and kind, each inferior to his Father. The Fathers, the boneless, could give no life to beings with bones. Their progeny were Bhûta, with neither form nor mind. Therefore they are called the chhâya."

The meaning of this is that the Lords of the Moon, the Barhishad Pitris, descending on to the Imperishable Land, separate from their own etheric bodies a chhâya, or shadow, a seed of life, which contains within it the potentialities of development into human form.

By an effort of will, they duplicated their own etheric bodies, materialising, in fact, an additional etheric double, making it permanent, and then stepping out of it.

The forms are huge, filamentous, sexless, empty bhûtas, floating about in the dense atmosphere and in the seething seas. To us they would appear as gigantic phantoms. They sway and drift about; huge, indefinite, protista-like forms in etheric matter, with changing outline; containing the seeds of all forms, gathered up by the Barhishads during preceding evolutions, of a moon-like colour, yellow-white of varying shades.

Within the class of Barhishads, who undertook this work, there were seven distinct sub-classes, and each sub-class populates one of the seven promontories, previously mentioned.

Further, each of the seven sub-classes, representing seven grades of evolution, contained members of each of the seven types, or "rays," hence the phrase "seven times seven" in the passage quoted.

The 49 varieties thus provided afforded the incoming entities with appropriate vehicles suited to their varying stages of growth and type.

These protista-like forms oozed out from the etheric bodies of the Barhishads, much as the etheric double may be seen oozing out from the side of a medium (*vide The Etheric Double*, p. 89) and formed the bodies for the first human Race.

The forms themselves were not human, but into them came entities who evolved as human beings.

These huge forms, as said, drifted about, senseless and passive. The consciousness of the incoming entities, being on the âtmic level, could affect but very slightly the clumsy bodies. These showed only vaguely the sense of hearing, and a dim consciousness of fire.

The Monads brood over the forms, their Rays warming them into activity and shaping them into organs of communication with the outer world. Hence, because of the lofty consciousness which touches them, they are sometimes spoken of as the Race of the Gods; also as sons of Yoga, because the Barhishads sent out their chhâyas when immersed in yogic meditation. They have been called also the self-born, because they were not born from human parents. They are the second Adam of the Jewish scriptures.

The Barhishads, having given out their chhâyas, animated them with their own energy, galvanised them, as it were, into activity. The Sun itself helped by sending upon them his vivifying fire in answer to the cry of the Ruler of the nature-spirits for his help. [We may perhaps surmise that this means that they absorbed prâna, or vitality, from the sun.] These three—the Barhishads, the Sun and the nature-spirits—"produced by their joint efforts a good rûpa (form). It could stand, walk, run, recline or fly. Yet it was still but a chhâya, a shadow with no sense" (*The Secret Doctrine*, II, 18).

The presiding planet of the first Race was the Sun, or rather the mystic planet Uranus, which he represents.

Multiplication of these beings was by fission or by budding, the only methods of reproduction possible for them, as is the case even to-day for the protista, their nearest physical likeness. They expanded in size, and then divided, at first into two equal halves, and at later stages into unequal portions, thus budding off progeny smaller than themselves, progeny which grew in its turn and again budded off its young.

In this Race no definite sub-races can be spoken of, though there were seven stages of growth, or evolutionary stages.

Neither do they die; "Neither fire nor water could destroy them, (*The Secret Doctrine*, II, 18); fire, in fact, was their element, and of water they were unconscious.

We have already mentioned that they were developing the sense of hearing.

CHAPTER XXXII

THE EARTH: THE SECOND ROOT-RACE

DURING the ages of unknown length through which the first Race lived, the earth was settling down into quieter conditions, and cataclysms were local, no longer general. More land slowly appeared above the surface of the watery desert, stretching out from the promontories of the first continent, and forming a vast horseshoe, the second continent, called the Hyperborean, or Plaksha.

It occupied the area now called northern Asia, joining Greenland and Kamschatka, and was bounded on the south by the great sea which rolled where the Gobi desert now stretches its wastes of sand. Spitzbergen formed part of it, together with Sweden and Norway, and it extended south-westwards over the British Isles. Baffin's Bay was then land, which included the islands now existing there.

The climate was tropical, and richly luxuriant vegetation clothed the sunny plains. We should not connect with the name Hyperborean the associations now carried with it, for it was a gladsome land, full of exuberant vitality. The name Hyperborean took on its gloomy associations in later days, when the land had been swept of its inhabitants by a change of climate, and broken up by many cataclysms.

Some of the oldest known lands of the earth are remains of the Hyperborean continent: these are Greenland, Iceland, Spitzbergen, the most northerly parts of Norway and Sweden, and the extreme north cape of Siberia.

When the time was ripe for the second Race to appear, the nature-spirits built round the chhâyas denser particles of matter, forming a kind of stiffer shell on the outside, and "the outer of the first became the inner of the second" (*The Secret Doctrine*, II, 18).

Thus imperceptibly the first Race vanished into, merged in, and became the second, and the chhâya, which was all the body of the first, became the etheric double of the second. The second Race shows two marked types, responding slightly to the buddhic consciousness. It shows the duality, which is characteristic of that consciousness, coming out in its physical changes, as in its two senses of hearing and touch, for the sense of touch was added to the first Race sense of hearing.

As the Monad passed into the second Race, he thus added to his physical plane consciousness the sense of touch, and began to respond to the impact of water and air as well as of fire.

Faint, chant-like sounds issued from the nondescript forms that represented humanity, open vowel-like sounds, inarticulate, faintly indicating the stirrings of emotions moved from hidden springs.

Such consciousness as there was belonged to above rather than to below. There was dreamily quiet enjoyment, arising from

within, but little sense of pleasure or pain, stimulated from without. It was the Monadic consciousness, awake on the higher planes but not on the lower, and the forms were but slightly responsive, almost senseless, though more responsive than those of the first Race.

This race was called Kimpurushas, the children of the Sun and the Moon, "the yellow Father and the White Mother" (*The Secret Doctrine*, II, 19), hence of fire and water; and they were born under the planet Brihaspati or Jupiter.

Their colour was a golden-yellow, sometimes glowing almost into orange, sometimes of palest lemon shades, and these gorgeously-hued forms, filamentous, often tree-like in shape, some approaching animal types, others semi-human in outline, very heterogeneous in appearance, drifting, floating, gliding, climbing, crying to each other in flute-like notes through the splendid tropical forests, brilliantly green in the sunlight, with flowering creepers starred with dazzling blossoms—all these make a picture of gorgeous hues, the splendour nature in her exuberant youth, running over with life, movement, colour, outlines sketched in with a giant's hand, colours flung from an overflowing palette.

Of the two types mentioned, the earlier showed no trace of sex, but multiplied by expansion and budding like the first Race.

As the forms became harder, coated with a thicker shell of earthy particles, this form of reproduction became impossible, and small bodies were extruded from them, figuratively termed "drops of sweat", since they oozed out like sweat from the human skin, viscid, opalescent; these gradually hardened, grew, and took on various shapes.

There are many traces of this type of reproduction in the Purânîc stories, where it is stated that all races were born from the pores of the skin of their ancestors. In process of time slight indications of sexuality began to appear in these "sweat-born" of the second Race, and they showed within themselves adumbrations of the two sexes, and hence are spoken of as androgynes.

Study of the lower kingdoms to-day reveals all these stages still persisting, and we realise how the nature-spirits have been guided along a single plan, endlessly modified in details but ever the same in principles.

From germs thrown off by these second Race "men" the mammalian kingdom was gradually developed in all its immense variety of forms.

Animals below the mammals were shaped by nature-spirits from the types elaborated in the third round, sometimes aided by human emanations.

It will be recollected that, as a whole, the second Race was a recapitulation of the second round, and that the forms in the second round were those known as "pudding-bags." The second Root-Race also had this curious formless pudding-bag appearance.

Both the first and the second Root-Races were evolving on

the Earth before Mars was deserted, there being available for these primitive conditions on the Earth some entities whom Mars in its later stages was too advanced to accommodate.

Into these Races the Barhishads from Globe D of the Moon Chain brought a number of backward entities who served as special coaches for the laggards; many of the laggards repaid the special care bestowed on them, and later on entered the first sub-race of the third Root-Race, as its lowest type. They were known as egg-headed; we shall come to them again when we reach the third Root-Race, in the next chapter.

During the first and second Root-Races the population of the Earth was very limited, and the special help, mentioned above, appears to have been given to enable as many animals as possible to be pushed on so that they could become human before the "door is shut" in the middle of the fourth Root-Race.

In addition, everything possible was being done to bring forward all of whom anything could be made, before the coming of the Lords of Venus in the middle of the third Root-Race.

CHAPTER XXXIII

THE EARTH: THE THIRD ROOT-RACE (LEMURIAN)

DURING the third Race, the Lemurian, known in Hindu literature as the Dânavas, the process of recapitulating the first three rounds was continued, all that had happened in the middle of the third round being repeated in this third Race. This involved the materialisation of men on to the physical plane, and their separation into sexes. Before we study the process in detail, however, we will first consider the physical conditions of the earth itself.

The earth had been slowly changing. "The great Mother travailed under the waves . . . she travailed harder for the third (Race), and her waist and navel appeared above the water. It was the Belt, the sacred Himâvat, which stretches round the world" (*The Secret Doctrine*, II, 419).

The sea to the south of Plaksha covered the desert of Gobi, Tibet and Mongolia, and from the southern waters of this the Himalayan chain emerged. Slowly land appeared, from the foot of the Himalayas, to Ceylon, Sumatra, Australia, Tasmania and Easter Island; westwards to Madagascar and part of Africa; included also were Norway, Sweden, East and West Siberia and Kamschatka. This vast continent was Lemuria - the cradle of the Race in which human intelligence was to appear. Its ancient name is Shâlmali.

The equatorial continent of Lemuria at the time of its greatest expansion nearly girdled the globe, extending from the site of the present Cape Verd Islands a few miles from the coast of Sierra Leone, in a south-easterly direction through Africa, Australia, the Society Islands and all the intervening seas, to a point but a few miles distant from a great island continent - about the size of the present South America - which spread over the remainder of the Pacific Ocean, and included Cape Horn and parts of Patagonia.

In the course of ages the vast continent undergoes many disruptions, and is broken up into great islands. Norway sinks and disappears. 700,000 years before the Eocene of the Tertiary began there was a great outburst of volcanic fire, chasms opening in the ocean floor, and Lemuria as a continent disappeared, leaving only such fragments as Australia and Madagascar, with Easter Island, submerged and again re-uplifted.

The destruction of Lemuria was brought about principally by fire-volcanic action. It was raked by the burning ashes and the red-hot dust from numberless volcanoes-these, together with a great number of lakes and marshes, being characteristic of the land surface. The Lemurians thus met their doom chiefly by fire and suffocation-unlike the next Race, the Atlanteans, who perished mostly by drowning. Another contrast between the destruction of Lemuria and that of Atlantis was that while four

great catastrophes completed the destruction of Atlantis, Lemuria was eaten away by internal fires, the volcanic action being incessant.

About the middle of the life of Lemuria, there took place the great change of climate, which slew the remnants of the second Race, together with their progeny, the early third Race. "The axle of the wheel tilted. The Sun and Moon shone no longer over the heads of that portion of the sweat-born; people knew snow, ice, frost, and men, plants and animals were dwarfed in their growth" (*The Secret Doctrine*, II, 343- 344). The gorgeous hues of the tropic faded away before the breath of the ice-king; the polar days and nights of six months began, and for a while the remnants of Plaksha showed but a scanty population. The Imperishable Sacred Land, however, continued to exist as before.

Turning now to the Race itself, with its seven distinct sub-races, we shall see that the many schemes of reproduction characteristic of the third round re-appear in this third Race, and in fact run simultaneously in various parts of the earth. The bulk of the population passed through the successive stages and eventually became oviparous or egg-bearing. It seems that the various schemes of reproduction were suitable to egos at different stages of evolution, the earlier ones being kept in operation for the backward egos, after the bulk of the people had passed beyond them.

These changes began some 164 million years ago, and occupied 5½ to 6 million years, physical bodies changing very slowly, and reversion frequently taking place. Moreover the original number was small and needed time for multiplication.

The separation of the sexes took place in the Secondary Period, the third Race having then existed for 18 million years, perhaps for much longer; for it began in the Jurassic period of the Secondary, or Mesozoic age, the Reptilian Period, as it is sometimes called.

When the oviparous type became stable, the egg was preserved within the feminine body, and reproduction assumed the form which still persists.

Whilst the Lemurian bodies were composed of gases, liquids and solids, at first the gases and liquids pre-dominated, for as yet their vertebrate structure had not solidified into bones such as ours, and they could not, therefore, stand erect. Their bones in fact were 2 pliable as the bones of infants now are. It was not until the middle of the Lemurian period that man developed a solid bony structure.

THE FIRST SUB-RACE

In the first sub-race, the method of reproduction was by extrusion of soft, viscid bodies - the "sweat" - whence they derive their name of the "sweat-born." Within the body the sexes scarcely showed at all.

The consciousness of the first sub-race showed a unity, being in touch with Âtmâ only.

As was mentioned in the preceding chapter, the Barhishads from Globe D of the Moon Chain had brought into the first and second Root-Races certain backward entities who served as special coaches for the even more backward entities in those two Races. Some of these benefited by the coaching and were brought into the first sub-race of the third Root-Race, as its lowest types.

They were egg-headed, with an eye at the top of their heads, a roll like a sausage representing a forehead, and prognathous jaws.

The egg-headed type persisted for a very long time, but became much modified in the later sub-races. Traces of it were found even in the seventh sub-race.

After them, either in this sub-race or a little later (the exact point is obscure) a very considerable number of egos, who had developed their basket-work causal bodies into complete causal bodies on Mars, began to come in. These took the lead in the Earth humanity, preparing the way for the more advanced egos who were soon to arrive from the Moon Chain. This was the group that had fought the "water-men, terrible and bad" on Mars.

Diagram XL illustrates the third Root-Race and numerous groups of entities who incarnated in it.

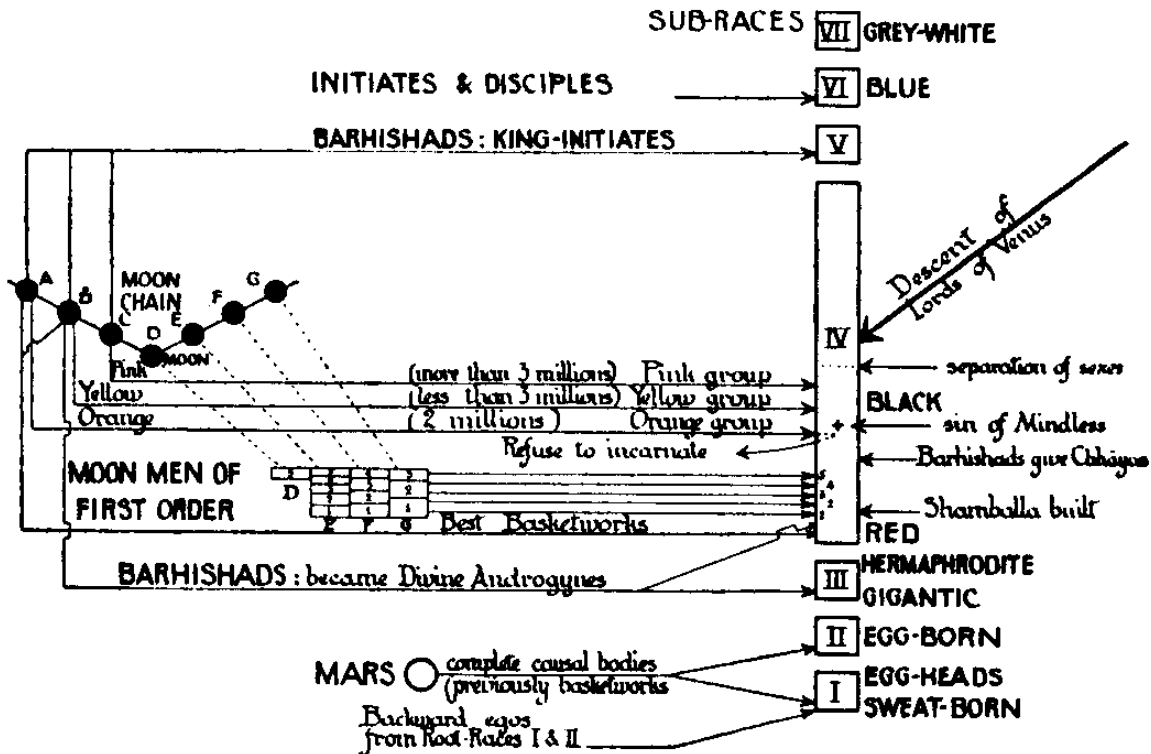

DIAGRAM XL.—The Third Root-Race (Lemurian).

THE SECOND SUB-RACE

In the second sub-race, the exuded bodies hardened: "the drops become hard and round. The Sun warmed it; the Moon cooled

and shaped it; the wind fed it until its ripeness" (*The Secret Doctrine*, II, 20). The soft bodies thus gradually became encrusted, the outer covering of the envelope hardening, and took the form of eggs, the ovum, which from that time to the present day is the natal home of the germ. Within the egg the forms gradually evolved into definitely androgynous creatures, distinctly human in type. These are called sons of passive Yoga, because they seem so abstracted from outer things.

The consciousness of the second sub-race exhibited a duality, being in touch with Âtmâ-Buddhi.

In *The Pedigree of Man*, the first two sub-races are spoken of collectively as the "early third"; they were born under Shûkra, or Venus, and under this influence they were evolved into hermaphrodites. The races separated under Lohitanga, or Mars, who is the embodiment of Kâma, the passion-nature.

THE THIRD SUB-RACE

In the third sub-race, the creature developed within the envelope, which was now a shell, and which became thinner and thinner, and evolved double sex organs. When born, by the breaking of the envelope, it was fully developed, like the chicken of the present day, and able to walk and run.

These were hermaphrodites; later, hermaphrodites with one sex predominating. Still later, they developed into uni-sexual beings.

They, together with the fourth sub-race, have been called the Lords of the Wisdom, a name which, however, properly belongs to a certain class of Barhishads who, as we shall see presently, came into them and used them as vehicles, in order to evolve, from the best third sub-race, bodies suitable for the fourth sub-race, in which sexes would be definitely separated.

The consciousness of the third sub-race was a triplicity, being in touch with Âtmâ-Buddhi-Manas.

Like all the forms then on earth, the third sub-race man was gigantic in bulk, compared with his present size. He was the contemporary of the pterodactyl, the megalosaurus, and other gigantic animals, and had to hold his own among them.

Organs of vision were evolved in the third Root-Race; at first there was the single eye in the middle of the forehead - later called the third eye - and then the two eyes. But the two eyes were little used by third Root-Race men until the seventh sub-race; and they did not become the normal organs of vision until the next Root-Race - the fourth.

This "third" eye, developed under the influence of the Monad, possessed far greater powers of vision than the two later eyes, or, more accurately, offered less obstruction to the perceptive power of the Monad. But, as the Monad drew back before the intellect, the physical triumphed, and the two feeble organs of vision, which we call eyes, were gradually developed, these being greater obstacles to the Monad's power of perception, but yet giving a sharper definition of objects, and so leading to a

keener vision than before.

The "third" eye gave impressions of the physical in the mass rather than in detail, and the temporary closing-in was the way to clearer sight.

Third Race men who possessed the "third" eye, although apparently savages in form, were none the less intuitional, responding quickly to the impulses sent out by the Divine Kings (who will be described presently).

The atrophied remnant of the third eye is now known as the pineal gland. This is now a centre solely of astral vision, but to the Lemurians it was the chief centre not only of astral but of physical sight. This psychic vision continued to be an attribute of the race not only throughout the whole of the Lemurian period, but well into the days of Atlantis - fourth Root-Race.

The first and second Root-Races, not being physical, had no need to produce a series of sounds in order to convey their thoughts; but when man became in the third Race physical, he could not for long remain dumb. The sounds which the primitive men made to express their thoughts were at first composed entirely of vowels. In the first two sub-races it consisted of mere cries of pleasure and pain, of love and anger; in the third sub-race it became monosyllabic, and in fact in Lemuria never reached beyond that stage, the consonant sounds gradually coming into use. The Chinese of to-day is the sole great lineal descendant of Lemurian speech, for "the whole human race was at that time of one language and of one lip" (*The Secret Doctrine*, II, 208).

THE FOURTH SUB-RACE

We come now to the fourth sub-race. But the student should understand that the development of one sub-race from the preceding one is a very gradual process, extending over a long period of time, so that it is often difficult to draw a sharp line of division between one sub-race and the succeeding one.

It will be recollected that the third sub-race had been brought up to the point where eggs were being laid, this being a stage in the whole process of the complete separation of the sexes, a process which, as already said, occupied some 5½ to 6 million years.

To some of the eggs very special treatment was applied. They were taken away by the Lords of the Moon, and were carefully magnetised and kept at an equable temperature, until the human form, at this stage a hermaphrodite, as just said, broke out. It was then specially fed and carefully developed, and, when ready, was taken possession of by one of the Lords of the Moon. Many of these Barhishads thus incarnated in order to work on the physical plane, and for a long period of time they used these carefully prepared bodies. This seems to have been only a few centuries before the separation of the sexes.

By the end of the fourth sub-race, the young creature

emerging from the egg could no longer walk, having become steadily more and more helpless at birth.

The human embryo still reproduces the stages which have been described; it shows the amoeba-like form of the first Race; the filamentoid form of the second Race; the sexlessness of the early stages passes into an androgynous state, and then slowly male or female predominates, determining the sex, as in the third Race. It should also be noted that the traces of sex-duality never disappear, even in maturity, the male retaining the rudimentary organs of the female, the female of the male.

These varied modes of reproduction are preserved in some of the Hindu myths; thus, in the account of the sacrifice of Daksha, various modes are given: "From the egg, from the vapour, vegetation, pores of the skin, and, finally, only, from the womb" (*The Secret Doctrine*, II, 193, quoting the Vâyu Purâna).

While the later Egg-borns - as they have been called - were in possession, the very best of the basket-works - probably those from Globes A and B of the Moon Chain - came in. These were quickly followed by the lowest of those who had gained complete causal bodies on the Moon (Moon-Men of the First Order). Between the best of the basket-works and the lowest of those with complete causal bodies there was but little difference.

Of those with complete causal bodies, we can distinguish 5 batches or boat-loads.

(1) Those from Globes G, F and E of the Moon Chain, the majority being from Globe G, the least evolved of the three sets.

(2) A large number from Globe G, a low section from Globe F, and a still lower section from Globe E.

(3) The best from Globe G, some fairly good ones from Globe F, some good ones from Globe E.

(4) The best from Globe F, and all but the very best from Globe E.

(5) The best from Globe E, with a few from Globe D (the Moon itself).

These were sorted out by stage of growth rather than by type, for they were, in fact, of all types. Amongst them one was noticed who had individualised through fear. Altogether there were some hundreds of thousands of these egos, incarnating among the Egg-born.

It was mentioned above that some of the Barhishads came and incarnated on the Earth. For this purpose they took the best forms available from what is called in *The Pedigree of Man* the "middle" third, i.e., the third and fourth sub-races. These incarnated Barhishads were called the Divine Androgynes, or the Divine Hermaphrodites. They moulded their forms into divinest beauty, towering giants, splendid in figure and feature. With their coming, and the subsequent separation of the sexes, ended the Satya Yuga of the Earth.

These Divine Androgynes were of a glorious red-gold hue, indescribably glowing and splendid, the glory of their general aspect being enhanced by the single eye that flashed like a jewel from its dazzling setting. The earthen reds of the crude and

clumsy forms of the first men and women, after the separation of the sexes, compare very unfavourably with the forms of the Divine Androgynes.

Gigantic in height and correspondingly broad, they give the impression of tremendous power, as far beyond the men of our own generation as the Anoplatheridæ and Palæotheridæ, which surround them in their later days, are beyond the oxen, deer, and pigs, and the horses, tapirs and rhinoceroses that have descended from them.

The men who followed them, with retreating forehead, the dully lurid eye, glowing redly over the flattened nose, the projecting heavy jaws, offer a repulsive appearance, according to modern tastes.

The memory of the "third" eye of course persisted in the Grecian story of the one-eyed Cyclops - as the one-eyed were called in later days - and of Ulysses, a man of the fourth Root-Race, slaying a Cyclops of the third Root-Race, who had a central eye.

Under the guidance of the Divine Androgynes, who ruled as Divine Kings, this sub-race built mighty cities, huge cyclopean temples, mighty and massive, built so that fragments still remain. They built Shamballah itself, the Holy City, the Sacred Dwelling-place, which still stands unshaken, a witness to the skill that planned and the strength that built.

About 10 or 11 million years ago, as we have seen, the separation of the sexes was fully established, and a reasonable continuity of form had been achieved. A number of special efforts were then made, by the Authorities in charge, to consolidate humanity and set it definitely on its way to the higher spiritual advancement which lay before it on the upward arc of the chain. It will be recollected that the precise middle point of the whole chain will be the middle of the next Race - the fourth; so now we find preparations for the second or upward half of the chain being made slightly before the exact middle point.

The first step in this preparation was a repetition, by the Lords of the Moon, of the chhâya episode, which was described in the chapter dealing with the first Race. For, after giving their chhâyas for the first Race, the Barhishads left the earth, ascending to Mahâloka for a while. "Having projected their shadows and made men of one element, the Projenitors re-ascend to Mahâloka; whence they descend periodically, when the world is renewed, to give birth to new men" (*The Secret Doctrine*, II, 16). As before, there were seven of them, "each on his own lot," in order to provide vehicles for the seven great types or rays of men.

The other entities of lower race, who were just being brought down to the physical level, eagerly seized upon these etheric "shadows" or vehicles, entered them and tried to use them. Not being fully adapted to them, they found it difficult to maintain their position, and were constantly slipping out. As soon as this happened, some other entity would seize the etheric body, and slip into it as though it were an overcoat, only

presently to find it slipping from him in turn, and to see it seized by somebody else.

The scene recalls the Greek idea that the Gods made the world amid shouts of laughter, for it decidedly had its comic element, as the egos struggled for the forms and could not manage them when they had obtained them. This is one of the "descents into matter" the final materialisation of the body of man, the completion of the "fall of man."

Many of these etheric doubles were made, and by degrees the less developed people, becoming accustomed to their new "coats of skin," learnt how to inhabit them permanently, so that the process of further materialisation could be undertaken.

In this way gradually bodies were produced which served to express the seven great types and their sub-types, and the people settled down to reproduce them steadily. In various parts of the world other ways of reproduction continued for long periods of time; the successive stages overlapped very much, owing to the great differences in evolution.

The tribes that followed the early methods of reproduction gradually became sterile, while the true men and women multiplied greatly, until humanity, as we now know it, was definitely established all over the world.

Other classes of egos continued to come into incarnation - those from other rounds, who had not been in the first or second Root-Races on the Earth.

At this stage there were 5 human classes, pressing on each other to obtain better human forms. Commencing with the most primitive, these were:

- (1) Those who were only now coming up from the animal kingdom.
- (2) Those with line causal bodies, who had been on the Earth for some time.
- (3) Basket-works from Mars.
- (4) The best basket-works from the Inter-Chain Nirvana.
- (5) The 5 classes previously enumerated, who had complete causal bodies, having come from Globes G, F and E of the Moon Chain.

The forms as thrown off by the Lords of the Moon were fairly good-looking, but being etheric they were readily modifiable, and the incoming egos much distorted them. The bodies of the children of these entities were by no means equal to those of their fathers, but were distinctly ugly; probably those using them were accustomed to think of the egg-shaped head and sausage-roll forehead, and hence these forms re-appeared. Nevertheless certain types were established, and however much the forms deteriorated they were still habitable.

After many generations of well-established human beings, descended from the etheric materialised forms, had been evolved, the Barhishads brought down, to take possession of the bodies thus fashioned, those egos who had individualised on Globes A, B and C of the Moon Chain.

There were three batches of these: (1) More than 2 million

of the orange group from Globe A; (2) rather less than 3 million of the yellow group from Globe B; (3) rather more than 3 million of the pink group from Globe C. Say about 9 millions in all. They were guided to different areas of the world's surface, with the view that they should form tribes.

Then a curious thing happened. "One-third refuses; two-thirds obey." The orange group of egos; on seeing the bodies offered to them, refused to enter, not out of any wickedness, but from sheer pride, disdaining the unattractive forms, and also perhaps from their ancient hatred of sexual unions.

The yellow and pink groups, however, were docile, and obeyed, gradually improving the bodies they inhabited. Thus was made the fourth Lemurian sub-race. This was the first which was in any sense, except the embryonic, human; and it may be dated from the giving of the forms by the Barhishads.

In *The Secret Doctrine* H. P. Blavatsky speaks of this fourth sub-race as "yellow," apparently from the colour of the incoming yellow egos from Globe B of the Moon Chain. The sub-race itself was black, this colour persisting for some time into later sub-races, as we shall see presently.

The descendants of these monsters, having through long centuries dwindled in size and become more densely physical, culminated in a race of Apes in the Miocene period, from which are descended the pithecoids of to-day. With these apes the Atlanteans (fourth Race) renewed the "sin of the mindless"—this time with full responsibility, the results being the Apes we know as Anthropoid (*vide The Secret Doctrine*, II, 728).

It seems that these anthropoids will obtain human incarnation in the coming sixth Root-Race, doubtless in the bodies of the lowest races then existing on earth.

The area allotted to the orange group was thus left vacant. The bodies, which they should have used, were gladly seized upon by the entities just emerging from the animal kingdom, the very lowest human type. The consequence of this was, that instead of maintaining the advancement which had been gained by so much effort, the forms were allowed to drop back again into a condition even worse than before. The primitive humans inhabiting the forms even intermingled with some of the animal forms, quite naturally feeling little difference between themselves and the ranks from which they had only just emerged.

This was what H. P. Blavatsky called the "sin of the mindless," and the result of it was various types of anthropoid apes.

The *Book of Dzyan* thus graphically describes the episode just mentioned:

"During the Third, the boneless animals grew and changed; they became animals with bones, their Chhâyas became solid.

"The animals separated the first. They began to breed. The two-fold man separated also. He said: 'Let us as they; let us unite and make creatures.' They did.

"And those which had no Spark took huge she-animals unto them. They begat upon them dumb races. Dumb they were themselves.

But their tongues untied. The tongues of their progeny remained still. Monsters they bred. A race of crooked red-hair-covered monsters going on all fours. A dumb race to keep the shame untold.

"Seeing which, the Lhas who had not built men, wept, saying: "'The Amanasa [mindless] have defiled our future abodes. This is Karma. Let us dwell in others. Let us teach them better, lest worse should happen.' They did."

"Then all men became endowed with Manas. They saw the sin of the mindless."

The karma of the refusal of the orange group of egos to take their due place in the work of peopling the world was that, later on, they were forced into incarnation and had to take even lower and coarser bodies, the Lords of the Moon having by that time gone on to other work. They thus became a backward race, cunning but not good; and passed through many unpleasant experiences. They diminished in number by constantly coming into collision with the common order, and being hammered; largely by suffering, into ordinary folk.

A few, strong, remorseless and unscrupulous, became Lords of the Dark Face in Atlantis (as we shall see when we come to deal with the fourth Race). Some were seen among the North American Indians with refined but hard faces; some few still persist, even down to our own day; by nature they are "turbulent and aggressive, independent and separative, prone to discontent and eager for change." They are the unscrupulous among the kings of finance, statesmen like Bismarck, conquerors like Napoleon. But they are gradually disappearing, for they have teamed many bitter lessons.

Those who are wanting in heart, who are always fighting, always opposing everything everywhere, on general principles, must ultimately be beaten into shape; a very few may end in black magic, but the steady pressure is too great for the majority.

THE FIFTH SUB-RACE

The Barhishads from Globes A, B and C of the Moon Chain now came into incarnation, to help the Manu in founding the fifth, sixth and seventh sub-races. In these later sub-races the Barhishads became Kings - the King-Initiates of the myths - which are often truer than history.

A King-Initiate would gather a number of persons round Him, forming a clan, and then would teach this clan some of the arts of civilisation, and direct and help them in the building of a city. One large city was erected under such instruction on what is now the island of Madagascar, and many others were similarly built in other parts of the Lemurian continent. The style of architecture was cyclopean, impressive by its hugeness.

During the long period thus occupied, the physical appearance of the Lemurians was changing. The central eye at the top of the head was retreating, as it ceased to function, to the interior of the head, to form the pineal gland, while the two

eyes - at first one on each side of it - were becoming active. The Greek legend of the Cyclops, as previously mentioned, is evidently a tradition from the early Lemurian age.

There was some domestication of animals, some of these being scaly monsters, almost as unattractive as their masters.

Animals of all sorts were eaten raw, some tribes even not despising human flesh. Creatures of our grades of slugs, snails and worms, much larger than their degenerate descendants, were regarded with peculiar favour as toothsome morsels.

Generally speaking the description of a third-round man would fit aptly enough the man of this fifth Lemurian sub-race. They have often been spoken of as the egg-headed people, from the resemblance of their skulls to an egg with the small end up. They had still but little forehead, and the eyes, as said, were set near the top of the egg.

They were black or brown-black.

The fifth, sixth and seventh sub-races of the Lemurian Race were much more what we should now call human than their predecessors had been.

The following is an abridged description of a Lemurian of one of the later sub-races - probably the fifth. "His stature was gigantic, between 12 and 15 feet. His skin was very dark, yellowish brown. He had a long lower jaw, a strangely flattened face, eyes small but piercing and set curiously far apart, so that he could see sideways as well as in front, while the eye at the back of the head enabled him to see in that direction also. Instead of a forehead he had a roll of flesh, the head sloping backwards and upwards. Arms and legs, especially arms, were longer in proportion than ours, and could not be perfectly straightened at elbows or knees. Hands and feet were enormous, the heels projecting backwards. The figure was draped in a loose robe of skin, something like rhinoceros hide, but more scaly. Round the head, on which the hair was short, was twisted another piece of skin to which were attached tassels of bright red, blue and other colours. In his left hand he held a sharpened staff, about 12 or 15 feet long. In his right hand was twisted the end of a long rope made of a creeping plant, by which he led a huge and hideous reptile, somewhat resembling the Plesiosaurus. The appearance of the man gave an unpleasant sensation; but he was not entirely uncivilised, being an average commonplace specimen of his day., Many were even less human than the individual here described.

THE SIXTH SUB-RACE

The men of the sixth sub-race were remarkable chiefly for their colour. They were no longer black or brown-black like the fifth sub-race; but blue-black, shading towards the end of the race into a distinct but rather livid blue.

They still showed a trace of egg-headedness, due to the retreating forehead.

While the sixth sub-race was developing, a large number of

Initiates and their disciples were sent off from the Inter-Chain Nirvana to the Earth, to help the Manu of the fourth Root-Race by incarnating in the best bodies He had so far evolved. The very best bodies were given to those who had exhausted their karma, their occupants being consequently able to improve them, and to get out of them everything which they were capable of yielding. These Arhats and their pupils worked under the Barhishads and the Manus of the third and fourth Root-Races, the seventh sub-race being evolved by their help.

THE SEVENTH SUB-RACE

The seventh sub-race, beginning as grey-blue, passed down through various greyish shades into a kind of grey-white. A fair idea of the type of their faces may be obtained from the statues which they themselves erected, some few of which still remain upon Easter Island. These statues, most of them about 27 feet high and 8 feet across the shoulders, were probably intended to represent both the features and the height of those who carved them, or possibly of their ancestors, for it was probably in the later ages of the Lemuro-Atlanteans that the statues were erected. The faces were long and horse-like, the tip of the nose being at first above the centre, and at the end of the race exactly in the centre, of a line drawn from the top of the forehead to the chin.

The forehead was still a mere roll of bone, though growing a little higher towards the end of the sub-race.

Like the sixth sub-race, they still exhibited a trace of egg-headedness, owing to the retreating forehead.

They had thick clumsy lips, and broad and flat noses, characteristics which have survived in a less aggravated form among the negroes, who are perhaps now their nearest representatives.

The stature had perceptibly decreased, and the appearance of hands, feet and limbs had become more like those of negroes of to-day. The men of the later sixth and seventh sub-races were great builders in a rough cyclopean fashion, and they had also a certain rude idea of art. They developed an important and long-lasting civilisation, and for thousands of years dominated most of the other tribes who dwelt on the vast Lemurian continent, and even at the end, when racial decay seemed to be overtaking them, they secured another long lease of life and power by inter-marriage with the Rmoahals, the first Atlantean sub-race. The progeny, while retaining many third Race characteristics, really belonged to the fourth Race, and thus acquired fresh power of development. Their appearance now became not unlike that of some American Indians, except that their skin had a curious bluish tinge not now to be seen.

The first cities were built on that extended mountainous region which included the present Island of Madagascar. Another great city is described in *The Secret Doctrine*, II, 331, as having been built entirely of blocks of lava. It lay some 30

miles west of the present Easter Island and was subsequently destroyed by a series of volcanic eruptions.

No race of pure Lemurian blood now exists; though the pigmies of Central Africa appear to represent a long-isolated fragment of the fourth sub-race; decreased to their present stature during millions of years in accordance with that curious law which appears to impose diminution of size upon the last relics of a dying race.

Most negro tribes have a considerable admixture of Atlantean, or fourth Race, blood; in the case of the Zulus, for example, we have in general build and bearing a close representative of the second Sub-race of the Atlanteans, the Tlavatli, although the colour and some of the faces are Lemurian.

Degraded remnants of the third Race may be recognised also in the aborigines of Australia, the Andaman Islanders, some hill tribes of India, the Tierra-del-Fuegians, the Bushmen of Africa, and some other savage tribes. The entities now inhabiting these bodies must have belonged to the animal kingdom of this chain.

There existed in Lemuria a Lodge of Initiation, but it was not primarily for the benefit of the Lemurians. Such of them as were sufficiently advanced were; it is true; taught by the Adept Gurus; but the instruction they required was limited to the explanation of a few physical phenomena, such as the movement of the earth round the sun; or the reason for the different appearance which physical objects assumed when viewed alternately by physical and by astral sight. The Lodge, however, was intended primarily for those entities who had come from Venus and who, while helping to direct evolution on the earth, were at the same time pursuing their own evolutionary development.

CHAPTER XXXIV

THE COMING OF THE LORDS OF VENUS

WE come now to describe the most dramatic moment in the history of the Earth - the Coming of the Lords of the Flame; an event for which long preparations had been made.

The Barhishads and the Manu of the Third Race had done all that was possible to bring entities up to the point at which the germ of mind could be quickened, and the descent of the ego could be made. All the laggards had been pushed on; there were no more in the animal kingdom capable of rising into the human. The "door" would be "shut" against further immigrants from the animal into the human kingdom only when there were in sight no more candidates capable of reaching the human level; without a repetition of the tremendous impulse which can be given once only in the evolution of a Scheme, at its midmost point.

A great astrological event, when a very special collocation of planets occurred and the magnetic condition of the Earth was the most favourable possible, was chosen as the time. It was 16½ million years ago. Nothing remained to be done, save what only They could do.

Then, "with the mighty roar of swift descent from incalculable heights; surrounded by blazing masses of fire which filled the sky with shooting tongues of flame, flashed through the aerial spaces the chariot of the Sons of the Fire, the Lords of the Flame from Venus; it halted, hovering over the White Island, which lay in the Gobi Sea; green was it, and radiant with masses of fragrant blossoms, Earth offering her best and fairest to welcome her coming King" - the great Being known as the King of the World, the Sanat Kumâra, with his three Assistants, and the remainder of His band of helpers.

In Chapter XIX this band has already been described, and also most of what is known of the King and His work in this world. It is necessary, therefore, only to recapitulate and amplify what has already been said, with special reference to the epoch of the world's history with which we are now dealing.

The Secret Doctrine, as we saw, spoke of Them as projecting the spark of mind into the mindless men and awakening the intellect within them. The meaning of this is that They acted as a magnetic stimulus; They shone upon the people as the sun shines upon flowers, and drew them up towards Themselves, thus enabling them to develop the latent spark and to become individualised.

H. P. Blavatsky mentioned some of the "sons of mind, as incarnating among the people whom they were trying to help. The Lords of the Flame did not Themselves incarnate among men in the ordinary way; H. P. Blavatsky was here referring to the Barhishads who did enter into ordinary human bodies and so for a time became part of the race.

But for the help kindly given to us by these great Leaders, the world would have been a very different place to-day. Without

Them not only would millions, who became human under the impetus which They gave, be still in the animal kingdom, but all the rest of humanity would be far behind the position in which it now stands.

The fourth round being especially destined to the development of the desire-principle in man, it is only in the next or fifth round that man is intended to devote himself to the unfolding of the intellect. Owing, however, to the stimulus given by the Lords of the Flame, the intellect has already been considerably developed, and we are therefore a whole round in advance of where we should have been but for Their help.

We also saw previously that They brought to the Earth bees, ants and wheat.

Until the Coming of the Lords of the Flame the batches or ship-loads from the Inter-Chain Nirvana had arrived separately, but now fecundity increased rapidly, like everything else, and large fleets were needed to bring in egos to inhabit the bodies. These came pouring in, while others of lower types took possession of all the animals with the germs of mind who were individualised at the Coming, the Lords of the Flame thus doing in a moment for millions what we now do by long care for units.

The Lords of the Flame arrived on the Earth about the middle of the third Root-Race, after the separation of the sexes. Diagram XL illustrates the Coming in its relation to other events.

It is part of the plan of the Logos that at a certain stage in its evolution humanity must begin to guide itself, instead of being dependent upon entities from other evolutions. Therefore all future Buddhas, Manus and Adepts will be members of our own humanity, the Lords from Venus having gone on to other worlds.

It may be noted here that the number of Adepts or Masters who retain physical bodies in order to help the evolution of the world is at present perhaps some 50 or 60 in all.

CHAPTER XXXV

THE FOURTH (ATLANTEAN) ROOT-RACE: THE RMOAHAL

THERE is available a good deal of information regarding the Fourth or Atlantean Root-Race, the classic book on the subject, for our purposes, being *The Story of Atlantis and Lost Lemuria*, by W Scott-Elliott. This book contains also four maps, covering roughly the following periods:

Map I from about 1,000,000 to 800,000 years ago.

Map II from about 800,000 to 200,000 years ago.

Map III from about 200,000 to 75,025 years ago.

Map IV from about 75,025 to 9,564 B.C.

During the first map period, Atlantis extended from a few degrees east of Iceland to about the site now occupied by Rio de Janeiro; it embraced Texas, the Gulf of Mexico, the Southern and Eastern States of America, Labrador, and the area from there to Ireland, Scotland and a small portion of the north of England. It reached also from Brazil to the African Gold Coast.

The second map period shows the distribution of land after the first great catastrophe about 800,000 years ago, in the Miocene Age. Much of the north of the continent was submerged, and the rest much rent. The growing American continent was separated by a chasm from the remainder of Atlantis, which then occupied the bulk of the Atlantic basin, from about 50° N. Lat. to a few degrees south of the equator. Considerable subsidences and upheavals in other parts of the world also took place, the British Isles, for example, forming part of a huge island embracing the Scandinavian peninsula, the north of France, all the intervening and some of the surrounding seas.

The third map period shows the land surface after the second catastrophe about 200,000 years ago, this catastrophe, however, being relatively much smaller than the first one. Atlantis proper was now split into a northern island called Ruta, and a southern called Daitya. The future North and South America were separated from one another, Egypt was submerged, and the Scandinavian island was joined to the future Europe.

The fourth map period shows the land surface after the stupendous convulsion which took place in 75,025 B.C. Daitya almost entirely disappeared, Ruta was reduced to the comparatively small island of Poseidonis, about the centre of the Atlantic ocean. The land surface was then roughly as it is to-day, though the British Isles were still joined to Europe, the Baltic Sea was non-existent, and the Sahara desert was still ocean.

In 9,564 B.C. Poseidonis was finally submerged.

The Troano MS., which appears to have been written about 3,500 years ago, among the Mayas of Yucatan, translated by Le Plongeon, gives the following description of the submergence of

Poseidonis:

"In the year 6 Kan, on the 11th Muluc in the month Zac, there occurred terrible earthquakes, which continued without interruption until the 13th Chuen. The country of the hills of mud, the land of Mu was sacrificed: being twice upheaved it suddenly disappeared during the night, the basin being continually shaken by volcanic forces. Being confined, these caused the land to sink and to rise several times and in various places. At last the surface gave way and ten countries were torn asunder and scattered. Unable to stand the force of the convulsions, they sank with their 64,000,000 of inhabitants 8,060 years before the writing of this book."

In addition to the four great catastrophes mentioned, there were many other minor ones.

The initiated kings and priests, who followed the "good law," were aware beforehand of the impending calamities. Each one, therefore, became a centre of prophetic warning, and ultimately the leader of a band of colonists. The names of the 7 sub-races are as follows:

- (1) Rmoahal.
- (2) Tlavatli.
- (3) Toltec.
- (4) Turanian.
- (5) Original Semites.
- (6) Akkadian.
- (7) Mongolian.

With the exception of the first two, the names chosen have been those given by ethnologists to traces of these sub-races, or parts of them, which they have found. The first two are given the names by which they called themselves.

THE FIRST SUB-RACE: THE RMOAHAL.

The Sanat Kumâra, the Head of the Hierarchy, began, almost immediately after His coming, to make arrangements for the founding of the fourth Root-Race. Accordingly, the fourth Race Manu selected the smallest, densest and best of the Lemurians, [from the fourth sub-race ?] at the time when they were under the guidance of the King-Initiates, and arranged for suitable egos to incarnate in the bodies they provided.

Much difficulty seems to have been experienced, tribes being segregated, their members intermarrying for long periods, the best being then selected and paired off with the best of another segregated party. The Manu and His disciples also incarnated in order to improve the physical type. It will be remembered that a number of Initiates and their disciples, from the Inter-Chain Nirvana, had incarnated in the Lemurian sixth sub-race, and that they had greatly improved the bodies of that sub-race. These improved bodies also the Manu used for His purposes, a large number of developed entities thus taking the lead and pressing

things forward.

Finally, the Manu took the bodies of the Lemurian seventh sub-race (bluish-white), improved by the Initiates using them, as the nucleus of His first sub-race - the Rmoahal. Only this group of Initiates and their disciples came into these bodies at first, there being none taken from those who had previously been evolving on the Earth Chain.

The colony of seventh sub-race people was settled on land represented at present by Ashanti and Western Nigeria, which was then a promontory to the north-west of the island-continent which embraced the Cape of Good Hope and parts of Western Africa. The colony was guarded for generations from admixture with a lower type, and increased in numbers until it was ready to receive the new impulse to physical heredity which the Manu was destined to impart.

The Manu had eliminated the blue from the colour of His people, passing through purple into red, and then, by mixing in the blue-white of the Lemurian seventh sub-race, obtained a type for the Rmoahals which we should call fully human, and that we could imagine as living among ourselves.

About a million years were spent in establishing the race-type, stupendous care and trouble having been taken to reach a fair resemblance to the type given to the Manu to produce. Then He may be said to have definitely founded the Race, He himself taking incarnation, and calling His disciples to take bodies in His own family, His posterity thus forming the Race. The Manu of a Race is, in the most literal sense, its Progenitor, for the whole Race has its Manu as its physical ancestor.

Even the Manu's immediate descendants, however, were not very attractive in appearance, although a vast improvement on the surrounding population. They were smaller than these, but had no nervous organisation worth speaking of, and their astral bodies were shapeless. He Himself moulded and shaped His physical body after His own astral and mental bodies, modifying the pigment in the skin until it became more nearly the colour designed for the Race.

After this many generations passed before the young Race took possession of its continent, Atlantis, but from this point onwards batches of egos began to come in from the Inter-Chain Nirvana, to inhabit the Fourth Race bodies.

We may note here that the Manu of the fourth Root-Race was one of the Adepts from Venus.

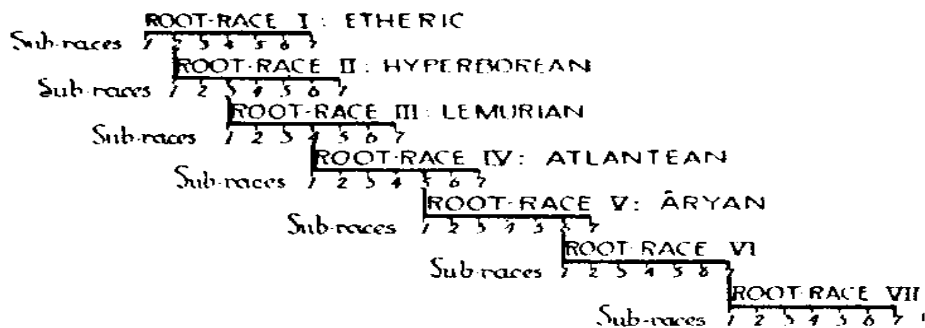

DIAGRAM NLI.—Evolution of Root-Races from Sub-Races.

It is convenient at this point to indicate the method by which a Root-Race is developed from its predecessor. The general principle seems to be that a Root-Race is developed from the numerically-corresponding sub-race of the preceding Root-Race. Thus, the *fourth* Root-Race should, by the rule, have been developed from the *fourth* sub-race of the third Root-Race; the *fifth* Root-Race was developed from the *fifth* sub-race of the fourth Root-Race; whilst the *sixth* Root-Race will be developed from the sixth sub-race of the *fifth* Root-Race. Diagram XLI illustrates the process.

In the case of the fourth Root-Race, however:, it seems that it was not until the time of the seventh Lemurian sub-race that humanity was sufficiently developed physiologically to warrant the final choice of individuals fit to become parents of the new Root-Race.

The Rmoahal race came into existence between 4 and 5 million years ago. Much of Lemuria still existed, and Atlantis had not yet become as large as it eventually became. The Rmoahal race was born about Lat. 7° N. and Long. 5° W., at a place which is now the Ashanti coast. It was a hot, moist country, where huge antediluvian animals lived in reedy swamps and dank forests; the fossil remains of such plants are now in our coal seams.

The race was at first mahogany black in colour. They were about 10 or 12 feet in height, their stature dwindling gradually through the centuries. They ultimately migrated to the southern shores of Atlantis, where they fought with the Lemurian sixth and seventh sub-races. Some of them settled down and inter-married with the black Lemurians. Others reached the extreme north-eastern promontories contiguous with Iceland; here they gradually became lighter in colour, and about a million years ago were tolerably fair.

Their occupation of these northern lands was not unbroken, because at intervals they were driven south by glacial epochs. A minor glacial epoch occurs about every 30,000 years; in addition, there are major epochs, one of which was in process about 3 million years ago.

The Rmoahals, being the children of the new Race, were themselves incapable of developing any plan of settled government, nor did they reach even as high a point of civilisation as the Lemurian sixth and seventh sub-races. They were ruled, therefore, by the Manu Himself, or by other Adept or Divine Rulers.

The brachycephalous, or round-headed specimen known as the "Furfooz man" may be taken as a fair average of the type of this race in its decay.

The modern Lapps, with some infusion of other blood, are descendants of the scattered and degraded remnants of the Rmoahals.

The government of the Rmoahals having been as described, the memory of their Divine Ruler was preserved, and in due time He came to be regarded as a god. Being to some extent psychic, this people adopted a religion which, though not profoundly

philosophical, was far from ignoble. In later days this phase of religious belief passed into a kind of ancestor-worship.

Amongst the Rmoahals, arts and sciences were crude in the extreme.

CHAPTER XXXVI

THE SECOND ATLANTEAN SUB-RACE: THE TLAVATLI

THIS sub-race arose on an island off the west coast of Atlantis; thence it spread across the continent, gradually tending northwards to the coast facing Greenland.

They were of a red-brown colour, powerful and hardy, but not quite so tall as the Rmoahals, whom they drove further north. They settled chiefly in mountainous districts approximately in an area which later became the island of Poseidonis.

Their tribes or nations were ruled by chiefs or kings who were acclaimed by the people on account of their being the most powerful individuals or greatest warriors. A considerable empire was eventually established among them, one king being the nominal head, though rather in titular honour than in actual authority.

Their colonists spread outwards in every direction. A mixture of this sub-race and the third sub-race - the Toltec - inhabited the western islands, which later formed part of the American continent; they reached also the extreme southern coasts, where Rio de Janeiro now is. Others occupied the eastern shores of the Scandinavian island, while numbers reached India, where they mixed with the indigenous Lemurians and formed the Dravidian race.

At a later period they occupied the south of South America, so that the Patagonians probably had remote Tlavalti ancestry. Remains of this sub-race, as of the Rmoahals, have been found in the quaternary strata of Central Europe, and the dolichocephalous "Cro-Magnon" man may be taken as an average specimen of the race in its decadence, while the "Lake-Dwellers" of Switzerland formed an even earlier and not quite pure offshoot. The only fairly pure-blooded specimens of the race now existing are some of the brown Indians of South America. The Burmese and Siamese are a mixture of the Tlavatli with one of the sub-races of the Fifth Root-Race (the Âryan).

The Tlavalti inherited the traditional reverence and worship for the Manu, but were taught by their Adept instructors to recognise a supreme being whose symbol was the sun. They thus developed a sort of sun worship; using for the purpose the tops of hills; where they built circles of upright monoliths. These both symbolised the sun's yearly course and also served for astronomical purposes, being so placed that, to one standing at the high altar, the sun would rise at the winter solstice behind one of the monoliths, at the vernal equinox behind another, and so on throughout the year. The stone circles were used also for more complicated astronomical observations of the more distant constellations.

The Manu brought into the Tlavatli sub-race some of the entities from Globe D (the Moon) of the Moon Chain, who had

individualised in the lunar fourth and fifth rounds.

Arts and sciences, among the Tlavatlis, were extremely crude.

CHAPTER XXXVII

THE THIRD ATLANTEAN SUB-RACE: THE TOLTEC

THE THIRD SUB-RACE: THE TOLTEC

THIS sub-race took its rise near the west coast of Atlantis, about Lat. 30° N. The whole of the surrounding country, and most of the west coast, was occupied by them. Later they extended right across the continent, their emperors holding almost world-wide sway from their capital on the eastern coast.

The people were a rich red-brown, redder or more copper-coloured than the Tlavatli. The first three sub-races have been spoken of as the "red" races, the four following as the "yellow" races.

The Toltecs were tall, averaging about 8 feet during their ascendancy, but later dwindling to the dimensions usual among us to-day. The type was an improvement on the two previous sub-races, the features being straight and well marked, not unlike the ancient Greek.

This sub-race was a magnificent development, the most splendid and imperial of the Atlantean peoples, ruling the whole of Atlantis for thousands of years in great material power and glory. So dominant and vital were they that the products of inter-marriage with later sub-races remained essentially Toltec. In fact, even hundreds of thousands of years later we find them ruling magnificently in Mexico and Peru, long before their degenerate descendants were conquered by the fiercer Aztecs from the north.

At first they were divided into a number of petty independent kingdoms, at war with each other and with the Lemurio-Rmoahals of the south. About a million years ago, after great wars, the separate kingdoms united in a great federation with an emperor at its head.

The second of these emperors was the Manu who founded the City of the Golden Gates, the first of many cities of that name. He also arranged for the incarnation at this time of a number of egos, with complete causal bodies, from Globe D (the Moon) of the Moon Chain, who had individualised in the lunar fourth and fifth rounds.

The Toltec, by virtue of its great superiority, was at this time the ruling race and subdued the rest of the world. The lower classes, however, were not of pure Toltec blood. Even in the City of the Golden Gates only the aristocracy and the middle class were Toltec, the lower classes being of mixed descent, largely composed of men and women taken captives in wars and reduced to servitude by the Toltecs. There arrived at this time also a group of "Servers" (*vide* p. 123), containing certain characters known in the "Lives" of Alcyone, such as Sirius, Orion and Leo. Some of

these were at once ear-marked by the Manu of the Fifth Root Race, Vaivasvata Manu, as part of His future materials.

Hence H. P. Blavatsky speaks of the founding of the Fifth Root-Race one million years ago, although it was actually led out from Atlantis only in 79,997 B.C.

The group of Servers, mentioned above, later formed the group with an average of 1,200 to 1,000 years' interval between incarnations. With the 1,200-year group were included the two egos who later became Masters with English bodies, Sir Thomas More and "Philalethes" or Thomas Vaughan.

The other, the 700-year group, did not arrive on the Earth until 400,000 years later.

For thousands of years the Divine dynasty ruled Atlantis, the islands on the west, and the southern portion of the land lying to the east. Usually the power was handed down from father to son, the dynasty being, when necessary, recruited from the Lodge of Initiates.

This was the golden age of the Toltecs, the rulers acting in harmony with the Occult Hierarchy. Government was accordingly just and beneficent; arts and sciences were cultivated and, with the assistance of occult knowledge; achieved tremendous results; religious belief and ritual were still comparatively pure; in fact the Atlantean civilisation was at its height.

After about 100,000 years of this golden age, degeneracy set in. Many of the tributary kings, as well as many of the priests and people, began to use their faculties and powers for personal aggrandisement, the attainment of wealth and authority, the humiliation and ruin of their enemies, and, in general, for all kinds of selfish and malevolent purposes. This led to "sorcery," and to the breaking of their connection with the Occult Hierarchy.

It is this desecration of psychic faculties and scientific attainments for selfish ends which constitutes "sorcery," and this, the "black art," rapidly spread. Higher spiritual guidance being withdrawn, the principle of Kâma (Desire), due in the natural course of things to reach its zenith in this Fourth Race, asserted itself more and more.

Lust, brutality and ferocity increased and the animal nature approached its most degraded expression.

Eventually the followers of the "black arts" rose in rebellion and set up a rival emperor who, after much struggle and fighting, drove the white emperor from his capital city - the City of the Golden Gates - and established himself on his throne.

The white emperor moved northwards and re-established himself in a city, now the seat of a tributary Toltec king, in the south of the mountainous district. The adherents of the white emperor gradually fell away from him; the hostile parties continually fighting one another, the destructive powers of the armies being supplemented by the use of sorcery.

This brings us to about 850,000 years ago, by which time more and more people had acquired and were practising the "black arts." The City of the Golden Gates had by this time become a den

of iniquity, and matters moved from bad to worse.

The emperor of the north, as well as the Initiated priests throughout the whole continent, had long been fully aware of the catastrophes at hand. Each one, therefore, became a centre of prophetic warning, and ultimately led an emigration. In the later days the rulers of the country deeply resented these priest-led emigrations, as tending to impoverish and depopulate their kingdoms, and it became necessary to get on board ship secretly at night.

About 800,000 years ago, the first great catastrophe occurred, the whole continent being terribly rent, whole provinces rendered by tidal waves desolate swamps, and the City of the Golden Gates being destroyed. Thus the black emperor and his dynasty fell; to rise no more.

This terrible warning was taken to heart, and for a time sorcery became less prevalent, but nevertheless during the whole period from now onwards the general tendency was for sorcery to become more and more prevalent.

During this period Corona, to be known later as Julius Cæsar, came from the City of the Golden Gates and conquered the Tlavatli tribe in which some members of the groups mentioned were incarnated. He treated the tribe kindly, assisted it, and incorporated it into the Toltec empire.

Batches of egos continued to arrive, the main cause of separation of the batches appearing to be the method of individualisation (*vide The Causal Body*, p. 82) which causes different intervals between incarnations. The various classes of Moon-Men and Animal-Men also kept separate from one another, as did the basket-works.

As stated previously, the first batch of the 700-year group arrived about 600,000 B.C., taking birth in the Tlavatlis, and including Surya, the chief of the tribe, Mercury his wife, Mars the eldest son, and Herakles as a daughter. Mars later became chief of the tribe, thus having his first experience of earthly rule.

Also at this time, about 600,000 B.C., the Head of the Hierarchy arranged for the incarnation of a special group of 105 egos, who had in Venus been pet animals of the Lords of the Flame, and strongly linked to Them by affection. They individualised on Venus and were all placed on the first or second Rays.

Another small group, from the third round, was sent to Mercury for special treatment in preparation for the Fifth Root Race, and came thence to the Earth at this time—thus accounting for those mentioned by H. P. Blavatsky as coming to the Earth from Mercury.

From this time forward, the 1,200 and the 700-Year groups formed what has been called the "Clan" and usually kept together. The whole Clan incarnated together in the City of the Golden Gates when Mars was king, in Peru when he was Emperor, in the mainland near the White Island under the Manu, and in the second and third sub-races at the beginnings and migrations—to name a

few out of many instances. The Theosophical Society of to-day is another meeting-ground of the Clan.

About 220,000 B.C. Mars was Emperor in the City of the Golden Gates, with the title of "Divine Ruler" transmitted from the Initiates of earlier days. Mercury was the chief Priest. These two come down the ages together, the one always as the Ruler, the other the Teacher and the Priest. Mars seemed to be always a man, though Mercury was sometimes a woman.

It was in this life that Ulysses, at the expense of his own life, saved that of Vajra, son of Mars. As Ulysses was dying, Mars said to him: "By the blood that was shed for me and mine, the bond between us shall never be broken. Depart in peace, faithful servant and friend." The bond became that of Master and disciple, for ever unbreakable.

When the Toltecs were at their zenith, the continent of Atlantis was probably as densely populated as England and Belgium now are, the population of the world being then about 2,000 millions, instead of, say, 1,200 to 1,500 millions as it is to-day.

The Toltecs, having emigrated chiefly to the west, spread abroad and flourished on what are now the continents of North and South America. The Peruvian empire under their Inca sovereigns, about 14,000 years ago, may be regarded as a traditional though faint echo of the golden age of the Toltecs on the mother-continent of Atlantis.

The best representative of the Toltecs to-day is the average Red Indian of North or South America, but of course he bears no comparison with the Toltec at his zenith. The Toltecs supplied the first great body of emigrants who mixed with and dominated the inhabitants of Egypt. About 400,000 years ago, Egypt being then isolated and thinly populated, a Lodge of Initiates, because of the spread of the "black arts" in their own country, emigrated to Egypt, and for nearly 200,000 years did its work there.

About 210,000 years ago, the Occult Lodge founded: the first Divine Dynasty of Egypt and an empire, bringing over for the purpose the first great body of colonists.

Between then and 200,000 years ago the two great Pyramids of Gizeh were built, partly to provide permanent Halls of Initiation, and partly to act as treasure-house and shrine for some great talisman of power during the submergence which the Initiates knew was impending.

It is legitimate to suppose that occult power was employed to facilitate moving and lifting the enormously heavy stones used in the Great Pyramid. Many thousands of years later, Cheops put his name on one of the Pyramids.

About 200,000 years ago Egypt was submerged and remained so for a considerable period. When it emerged again it was once more peopled by the descendants of its old inhabitants, who had taken refuge in the Abyssinian mountains, and by fresh bands of Atlantean colonists from various parts of the world. A considerable immigration of the sixth sub-race (the Akkadian)

helped to modify the Egyptian type. This was the era of the second Divine Dynasty of Egypt, the rulers again being Initiated Adepts.

The spread of black magic led up to the second great catastrophe, in 200,000 B.C., when the great continent was reduced to the two islands Ruta and Daitya.

For the next 100,000 years the people of Atlantis flourished, building up a mighty, but over-luxurious, civilisation. The capital was once more the City of the Golden Gates, a Toltec dynasty again rising to power, 5 on the island of Ruta, and ruling a large portion of the island. This dynasty also was addicted to the black craft.

It must, however, be borne in mind that down to the very end, when Poseidonis was destroyed in 9,564 B.C., an Initiate emperor or king, or at least someone acknowledging the "good law," held sway in some part of the island continent, instructing the small "white" minority and controlling where possible the evil sorcerers. In later days the "white" king was as a rule elected by the priests.

Members of the "Clan" were sometimes born into families addicted to the black art, occasionally dallying with it, sometimes breaking away. One incident is of particular interest, and may be briefly summarised here.

About 100,000 years ago, Corona was White Emperor in the great city, Mars being one of his generals, Herakles the wife of Mars. A great rebellion was plotted, headed by Oduarpa, a man of strange and evil knowledge, a "Lord of the Dark Face," leagued with the "Kingdom of Pan," semi-human, semi-animal creatures who are the originals of the Greek satyrs. Oduarpa gathered round himself, as Emperor of the Midnight Sun, a huge army He established a worship, with himself as the central idol, which was sensual, riotous, and held men by animal gratification. Against the White Cave of Initiation in the City of the Golden Gates was set up the Dark Cave of the mysteries of Pan, the Earth-God, in caverns deep in the earth.

Oduarpa, crafty and ambitious, was at the head of the Federation of the outlying kingdoms, which arrayed itself against the White Emperor. By his compact with the denizens of the nether world, he had abnormally extended his own life, and had materialised a metallic coating round his own body, which rendered him impervious to spears or sword-thrusts.

Alcyone, by instinct shrinking from the black practices and their orgies, was beguiled into taking some part in them by the allurements of a maiden, Cygnus. A wild and drunken revel ensued. Out of the earth emerged a wild procession of hairy bipeds, long-armed and claw-footed, with animals' heads and manes, non-human, yet horribly human. These gave the revellers drink and ointments which made them drop drugged and senseless on the ground.

From the huddled heaps there sprang animal forms, astral materialisations, fierce and conscienceless as animals, cruel and crafty as men, which passed into the outer world full of lust, snarling and ravaging, returning into the human forms again when

their orgy was over.

By means of these rites Oduarpa obtained firm hold over the people and gained great power also over the sub-human kingdom. He himself had a bodyguard of his magic animals, desire-forms materialised into physical bodies, and these he would loose at his enemies in battle: they fought with teeth and claws, spread panic among the startled hosts, and gorged on the bodies of the slain.

The decisive battle was fought against the White forces, at the City of the Golden Gates, Mars being slain by Oduarpa himself, Herakles captured and torn to pieces by the horrible animals.

Oduarpa became Emperor of the City of the Golden Gates, but not for long. Vaivasvata Manu came against him with a great army destroyed the artificially-created Pan animals, scattered Oduarpa's army, and slew Oduarpa himself.

The rule of the White Emperor was again set up in the City, now purified, but slowly the evil again gained power until Oduarpa, now reincarnated, fought against the White forces, defeated them, and set up his own throne. Then the Head of the Hierarchy spoke the words of doom, as the *Occult Commentary* states: the "Great King of the Dazzling Face" - the White Emperor-sent to his brother Chiefs: "Prepare. Arise, ye men of the Good Law, and cross the land while yet dry." The "Rod of the Four" - the Kumaras - was raised. "The hour has struck, the black night is ready." The "servants of the Great Four" warned their people, and many escaped. "Their Kings reached them in their Vimânas (aeroplanes) and led them on to the lands of fire and metal" (i.e., east and north).

Explosions of gas, floods and earthquakes destroyed Ruta and Daitya, and only Poseidonis remained. This was the catastrophe of 75,025 B.C.

In this catastrophe Egypt was again submerged, but this time it was only a temporary wave. The people tried to climb the Pyramids for safety, but failed owing to the smoothness of their sides. When the flood receded, the third Divine Dynasty, that mentioned by Manetho, began its rule, and under its early kings the Temple of Karnak and many more of the ancient buildings still standing in Egypt were constructed. With the exception of the two Pyramids, no building in Egypt is more than 80,000 years old.

In this catastrophe the Himalayas were heaved up a little higher, the land south of India was submerged, Egypt was drowned, only the Pyramids being left standing. The tongue of land which stretched from Egypt to what are now Morocco and Algeria disappeared, and the two countries remained as an island, washed by the Mediterranean and the Sahara Sea. The Gobi Sea became circular, and land was thrown up, now Siberia, separating it from the Arctic Ocean; Central Asia rose, and many torrents, caused by unprecedented rainfall, cut deep ravines through the soft earth.

Yet another tidal wave swept over Egypt when Poseidonis was submerged, in 9,564 B.C. This also was temporary, but it brought to an end the Divine Dynasties of Egypt, for the Lodge of

Initiates had transferred its quarters to other lands.

In Poseidonis the population was mixed, two kingdoms and a small republic in the west dividing the island between them, the northern portion being ruled by an Initiate king. In the south, too, the hereditary principle had given way to election by the people. Exclusive race-dynasties were at an end, but kings of Toltec blood occasionally rose to power both in the north and the south, though the north constantly lost territory to the south.

CHAPTER XXXVIII

THE CIVILISATION OF ATLANTIS

THE student will readily understand that the history of the Atlantean Race, as of the Aryan Race, was interspersed with periods of progress and decay. Eras of culture were followed by times of lawlessness, during which all scientific and artistic development was lost, these periods again being succeeded by civilisations reaching to still higher levels.

The following description, therefore, obviously applies to the periods of culture; and, whilst it is by no means exclusively applicable to any one sub-race, yet it may be taken to apply principally to the great Toltec civilisation, the chief of all the Atlantean civilisations.

Government was autocratic and, under the Divine Kings, no system could have been happier for the people. It was planned by the wise for the benefit of all, and not by special classes for their own advantage. Hence the general comfort was immensely higher than in modern civilisations. Governors were held accountable for the welfare and happiness of their provinces, and crime or famine were regarded as due to their negligence or incapacity. Rulers were drawn chiefly from the upper classes, but aptitude rather than class was the necessary qualification. Sex was no disqualification for any office in the State.

Music was practised, but it was crude, and the instruments most primitive. All the Atlanteans were fond of colour, both the insides and the outsides of their houses being brilliantly decorated. The art of painting, however, was never well established, though there; was some kind of drawing and painting. Sculpture was widely practised and reached great excellence.

It became customary for every man who could afford it, to place in one of the temples an image of himself. These were carved in wood or hard black stone like basalt, or even in aurichalcum, gold or silver. The result was a fair resemblance of the individual, sometimes a striking likeness.

Architecture was the art most widely practised, the buildings being massive and of gigantic proportions. Houses were built detached, even in cities, four blocks sometimes surrounding a central courtyard in the middle of which was a fountain.

A characteristic feature of the Toltec houses was the tower that rose from one of the corners or from the centre of one of the blocks. An outside spiral staircase led to the upper stories, and a pointed dome terminated the tower, this often being used as an observatory.

Some houses were ornamented with carvings, frescoes or painted patterns. The windows were provided with a material similar to glass, but less transparent. The interiors were furnished, but not in elaborate detail; nevertheless the life was highly civilised of its kind.

The temples were huge halls, even more stupendous than those of Egypt. The pillars supporting the roofs were square, or occasionally round. In the days of the decadence the aisles were surrounded with innumerable chapels containing statues of the more important inhabitants, ceremonial worship of the images being carried out by priests engaged for the purpose. The temples also had their towers and domes, which were used for sun-worship and as observatories.

The interiors of the temples were inlaid, or even plated, with gold and other precious metals, these metals being obtained by transmutation, this being a private industrial enterprise by which the alchemists earned their living. Gold, being more admired than silver, was produced in much greater quantity.

Gold, silver and aurichalcum were the metals most used for decoration and for domestic utensils. Armour was gorgeously inlaid with these metals, that used merely for show in pageants and ceremonies being often entirely made of precious metals; golden helmets, breastplates and greaves were worn on such occasions over tunics and stockings of the most brilliant colours - scarlet, orange and a very exquisite purple.

Buying and selling took place privately, except when large public fairs were held in the open spaces in the cities.

Up to about 800,000 years ago Toltec was the universal language, though remains of the Rmoahal and Tlavatli speech survived in remote districts. All the languages were agglutinative. All through the ages the Toltec language remained fairly pure and survived, with slight alterations, thousands of years later in Mexico and Peru.

All schools were endowed by the State, and primary education was compulsory, but reading and writing were not considered necessary for workers in the fields or in handicrafts. Children with aptitude were drafted into the higher schools at the age of twelve, where they were taught, as was most appropriate to each child, agriculture, mechanics, hunting and fishing, etc. The properties of plants and their healing qualities formed an important branch of study; there were no recognised physicians, but each man knew something of medicine as well as of magnetic healing.

Chemistry, mathematics and astronomy also were taught, the object being the development of the student's psychic faculties and instruction in the more hidden forces of nature. In this category were included the occult properties of plants, metals and precious stones, as well as alchemical transmutation. As time went on, they were principally occupied in developing the personal power, which Bulwer Lytton called *vril*, and the operation of which he fairly accurately described in *The Coming Race*.

As decadence set in, the dominant classes monopolised for themselves the educational facilities, natural aptitude being disregarded.

Having no sense of the abstract, the Atlanteans were unable to generalise; for example, they had no multiplication table;

arithmetic was to them a system of magic, a child having to learn elaborate rules without ever knowing the reason for them. Thus four sets of rules for mathematical magic had to be memorised for every combination of numbers from 1 to 10, viz., for addition, subtraction, multiplication and division.

Most of their calculations, however, were made by an abacus or framework, something like that now used by Chinese and Japanese.

The Atlanteans were clever at amassing facts, and had prodigious memories.

The habitual use of clairvoyance enabled them to observe the processes of nature, now invisible to most, so that science was carried far, its applications to arts and crafts being also numerous and useful. They had knowledge of forces, which to-day has been lost. One of these forces was employed to propel both air- and water-ships; another for changing the attractive force of gravity into a repelling force, so that the raising of gigantic stones to a lofty height was a matter of the greatest ease. The subtler of these forces were not applied to machinery, but were controlled by will-power, using the thoroughly-understood and developed mechanism of the human body.

Agriculture received much attention, experiments being carried out in the crossing both of animals and of plants. Wheat, for example, was crossed with the indigenous grasses of the earth and produced oats and others of our cereals. Less satisfactory were the attempts which produced wasps from bees, and white ants from ants. From an elongated melon with scarcely any pulp, and full of seeds, they produced the plantain or banana.

Among domesticated animals they had creatures like very small tapirs, which fed on roots or herbage, or on whatever came their way, like the modern pig. They had also large cat-like animals and wolf-like ancestors of the dog.

Their carts were drawn by creatures somewhat like camels, Peruvian llamas being probably descended from these. The ancestors of the Irish elk roamed about the hills, somewhat wild but still under the control of man.

Artificial heat and coloured lights were used in crossing and inter-breeding different kinds of animals, in order to expedite the process. They worked especially with amphibian and reptilian forms which had about run their course and were ready to assume the more advanced type of bird or mammal. Acting in co-operation with the Manu, from Whom originates all improvements in type, domestic animals like the horse were produced. But when war and discord set in, towards the end of the Golden Age, men began to prey on each other; and the animals, left to themselves, followed man's example, and also began to prey on one another. Some in fact were trained by men to hunt, and thus from the semi-domestic cat descended the leopard and jaguar. It seems that the lion would have been more gentle, and a powerful servant for purposes of traction; had men fulfilled the task entrusted to them by the Manu. In fact; if men had done all their duty, it is quite conceivable that we might have had no carnivorous mammals.

The City of the Golden Gates lay on the east coast about 15° north of the equator, and was surrounded by wooded park-like country, scattered over which were the residences of the wealthier classes. To the west lay a range of mountains, from which was drawn the water supply. The city was built on the slopes of a hill about 500 feet above the plain. On the summit of the hill lay the emperor's palace and gardens, in the centre of which welled up a stream of water, supplying the palace and the fountains in the gardens, and then flowing in four directions, falling in cascades into a canal which surrounded the grounds.

From this canal four channels led the water, through the four quarters of the city, to cascades which in their turn supplied another encircling canal. There were three such concentric canals, the lowest being still above the level of the plain. On the lowest level a fourth canal, on a rectangular plan, received the waters and discharged them into the sea (vide Diagram XLIII). The city extended up to the edge of the outermost canal, which was about 12 by 10 miles.

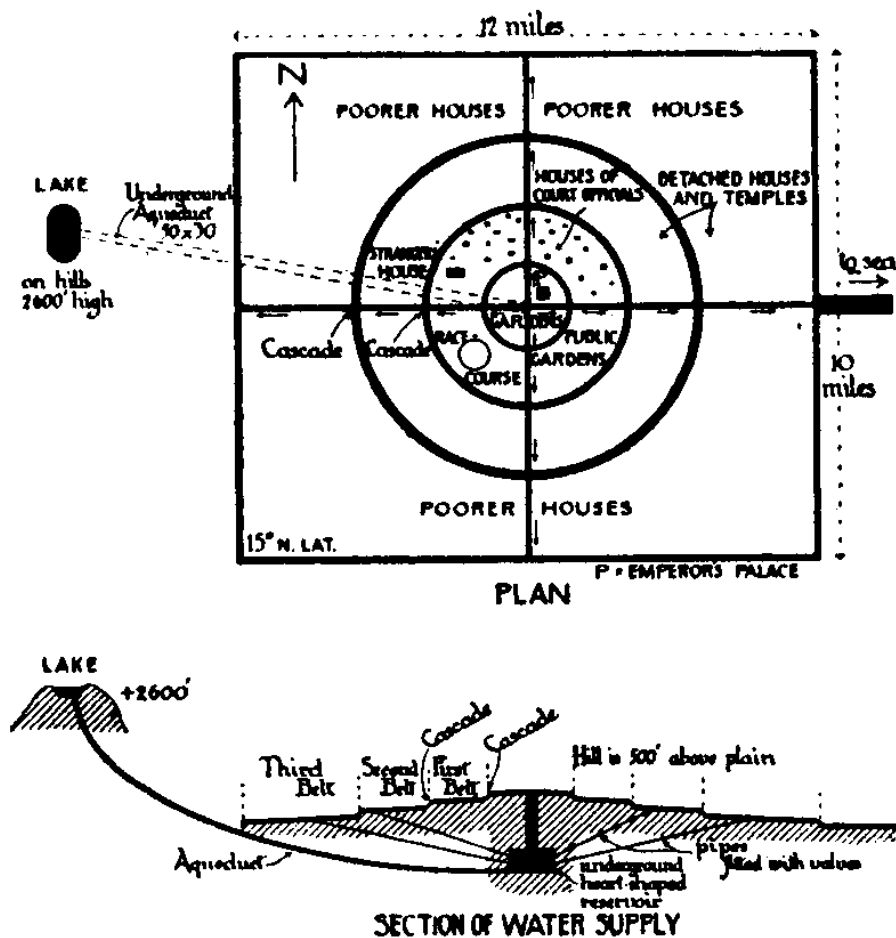

DIAGRAM XLII.—The City of the Golden Gates.

N.B.—Both plan and section are, of course, purely diagrammatic.

The uppermost of the three belts, into which the city was

thus divided, contained a circular race-course and public gardens, most of the houses of the court officials, and the "Strangers' House." This last was a palace where strangers were entertained, as guests of the Government, for as long as they cared to stay.

The other two belts were occupied by the detached houses of the inhabitants and the various temples.

In the days of the Toltec greatness there was no real poverty, even the slaves attached to most houses being well fed and clothed. But there were some comparatively poor houses in the lowest belt to the north, as well as outside the outermost canal towards the sea, where the inhabitants were connected mostly with shipping, their houses being closer together.

In the days of its greatness the City of the Golden Gates contained over two million inhabitants.

It was known also as the City of the Waters, because of its magnificent water supply, which was finer than anything which has been attempted since, in any age. The water came from a lake to the west, at an elevation of some 2,600 feet, the main aqueduct, of oval section, some 50 feet by 30 feet, leading underground to a huge heart-shaped reservoir, deep below the palace. From the reservoir a perpendicular shaft of about 500 feet up through the solid rock gave passage to the water, which welled up in the palace grounds. From the central reservoir also pipes led to different parts of the city to supply drinking water and the fountains. There were valves to control the various sections of supply.

The hydrostatic pressure must have been enormous, and consequently the strength of the material used in the aqueducts must have been very great.

Other towns, on the plains, were protected by immense banks of earth, faced on the outside with thick metal plates, thus forming a practically impregnable barrier against spears or arrows.

Airships were used by the wealthier classes; they contained from two to six or eight persons. In the later days of war and strife they constructed giant air-ships, which superseded battleships for the sea, and which contained 50, or even 100 fighting men.

The earlier ones were built of very thin wood, strengthened by the injection of some substance which did not add materially to the weight but greatly increased the toughness. Later they used an alloy, of two white metals and one red one, producing a white metal like aluminium, but even lighter in weight. This metal was beaten into shape over the framework and welded where necessary, producing a seamless and perfectly smooth surface which shone in the dark as though coated with luminous paint.

They were shaped like boats decked in, with propelling and steering gear at each end.

From the airships they dropped bombs filled with heavy poison-gas; allusions to these may be found in the great epics and Purânas of the Hindus.

In the earlier days the ships were propelled by *vril*, the personal power; this was later replaced by a force, generated in some unknown manner, and operating through mechanism. The force was etheric, and the generator was in a heavy metal chest in the centre of the boat. The force flowed through two large flexible tubes to each end of the vessel, and also through eight subsidiary tubes fixed fore and aft to the bulwarks, these having openings pointing both up and down.

To raise the vessel, the force was projected down-wards through the apertures in the tubes, impinging on the earth with force sufficient to drive the vessel upwards, the air acting as a fulcrum.

To drive the vessel forward, the force was projected downwards at 45°, thus maintaining the elevation and propelling the vessel; steering was effected also by means of the force projected from the tubes.

The maximum speed was about 100 miles an hour, the course being that of long waves in a vertical plane. They travelled at a few hundred feet elevation only, the rarefied air at greater heights being insufficient to provide the necessary fulcrum; but they could cross hills up to about 1,000 feet high.

They fought against other air-ships by using the force to upset the equilibrium of the enemy's vessels.

They had also sea-going ships propelled by some analogous power, but the most effective current force had a denser appearance than that used in the air-ships.

They had a good deal of complicated machinery, though we should consider most of it clumsy.

A curious trace of their limitations appears in the religion which the Egyptians inherited from them. They had names for most of the types of elemental essence and nature-spirits, and had special spells for each, by which it could be controlled. These they elaborately learnt, never realising that the force behind the spells in every case was the human will, which would have been equally effective without any spell at all. *The Book of the Dead* contains many of these, only that portion which it was thought each dead person would need being placed along with the body in the tomb.

Polygamy was practised at various times by all the sub-races; among the Toltecs two wives were allowed by law, but monogamy was quite usual. Women were regarded as in every way equal to men; many of them were the superiors of men in the use of the *vril* power. Co-education was practised, and women took part in government, sometimes representing the Adept emperor as local sovereigns.

Writing was done on thin sheets of metal, with a white porcelain-like surface. Reproduction of writing was achieved by dipping other sheets of metal in some liquid and then placing them on the original writing.

The Atlanteans ate flesh, but discarded the portions which we usually eat, consuming those portions which we discard, such as the entrails. They also drank blood, often warm from the

animal, and cooked dishes were also made of it.

Fish also was consumed, though often in an advanced stage of decomposition. They ate bread and cakes of cereals, as well as milk, fruit and vegetables. Fruit-juices were much used as drinks.

The Adept kings and emperors, however, as well as the initiated priests, were entirely vegetarian, though some of the court officials ate flesh-foods surreptitiously.

A very potent fermented liquor was at one time much in vogue, but later it was forbidden by law.

The Rmoahals and Tlavatlis used swords, spears, bows and arrows, with which they hunted mammoths with long woolly hair, elephants and hippopotami. Marsupials also abounded, as well as creatures half reptile and half mammal, others half reptile and half bird.

In later times explosives were carried to great perfection. Some exploded on concussion, others by what we should now call a time-fuse, but death resulted, not from the impact of bullets, but from the release of some poison gas. So powerful were these means of destruction that whole companies of men were killed by poison-gas, released from bombs exploded above their heads, thrown there by some sort of lever.

They had also weapons which projected sheaves of fire-tipped arrows, and many others, constructed by men well versed in the higher branches of scientific knowledge. Many of these are described in the ancient books of the Hindus, and are stated to have been given by, some superior Being. The knowledge required for their construction was never made common.

During the first three sub-races, state coinage was unknown, but stamped pieces of metal or leather were used as tokens, perforated in the centre and usually carried strung at the girdle. Each man made his own tokens, and used them as we use promissory notes, being entitled to fabricate only such quantity as he could redeem by the transfer of goods in his possession. The tokens did not circulate as coinage, whilst the holder of them was able by clairvoyance, which all to some extent possessed, to estimate accurately the resources of anyone from whom he received tokens. In later times Poseidonis used a system something like our own coinage, stamping on the currency a picture of the triple mountain visible from the great southern capital.

The Rmoahal and Tlavatli, living chiefly by hunting and fishing, had no need of a land system, though the Tlavatli had a system of village cultivation.

The increase of population and civilisation in early Toltec times made a land tenure system necessary, but, largely because of the excellence of this system, poverty and want were non-existent. The whole of the land and its produce, as well as the flocks and herds, were regarded as belonging to the emperor. The king or viceroy of each district was responsible in his own district for tillage, harvesting, pasturage and agricultural experiments. His agricultural advisers were versed in astronomy,

and took full advantage of occult influences on plant and animal life. They could produce rain at will; and could even partly neutralise the effects of a glacial epoch.

We may note here parenthetically that about 850,000 years ago, during the Toltec ascendancy, there occurred a glacial epoch which desolated most of Atlantis. During the winter, the northern inhabitants were forced to migrate far south of the ice-belt, returning again to their encampments for purposes of hunting in the summer.

Coming back to agriculture, the right day for each operation was duly calculated, and every detail was supervised. Each district usually consumed its own produce, though exchange sometimes took place with other districts.

After setting aside a small share for the emperor and the central government; the produce of the whole district was divided among the inhabitants, the local viceroy and his officials receiving the larger share, but everyone receiving sufficient to secure competence and comfort. Increase of production, whether agricultural or mineral, was shared by all, *pro rata*.

After a long period of successful working of this system, it declined, negligence, self-seeking and elaboration of luxury setting in. A particular cause of discontent was that the superior class, whose psychic faculties had been duly developed, delegated to their less highly trained subordinates the task of selecting children for the higher technical education. Many mistakes were thus made, and people found themselves tied for life in unsuitable and uncongenial occupations.

In the later days of Poseidonis the original system of land tenure gave way to that of individual ownership as we have it to-day.

A remnant of the original land-system survived until the time of the Incas in Peru, some 14,000 years ago. All land was vested in the Inca, but half of it was assigned to the cultivators, the other half, in equal shares, to the Inca and the priesthood, who were sun-worshippers.

Out of his share the Inca maintained the army, the roads and the whole machinery of government, which was in the hands of a special class, representing a culture and civilisation much in advance of the great mass of the people.

Out of their fourth share, the product of the "lands of the sun," the priests maintained themselves and the public worship, the entire education of the people in schools and colleges, as well as all sick and infirm persons, and pensioned off everyone over the age of 45, when leisure and enjoyment were considered proper.

In the days of the Toltecs, when an Adept emperor ruled, there was an initiated priesthood which constituted an immense occult fraternity, and began progress on the occult Path. These, of course, were the few, the masses being far behind them in spiritual development. Sun worship was adopted, the spiritually minded regarding the sun as a symbol, the ignorant being unable to see further than the outer symbol. Magnificent temples for sun

and fire worship were erected throughout Atlantis, but more especially in the City of the Golden Gates. No image of the Deity was permitted, the sun-disc being considered the only appropriate emblem, a golden disc being usually placed so as to catch the first rays of the rising sun at the vernal equinox or at the summer solstice.

This religious system survives in the Shinto worship in Japan, though, unlike the gorgeous temple decorations of Atlantis, the Shinto temples are exquisitely finished in plain woodwork, without carving, paint or any other decoration.

In later days the image of an archetypal man was placed in the temples, and adored as the highest representation of the divine.

The evil days, however, drew near, when the race would be overwhelmed in the abyss of selfishness. The ethical idea decayed and led to the perversion of the spiritual. Each man fought for himself and used his knowledge for selfish ends. The *Book of Dzyan* graphically describes the scene: "Then the Fourth became tall with pride. We are the kings it was said; we are the Gods. . . . They built huge cities. Of rare earths and metals they built, and out of the fires vomited, out of the white stone of the mountains and of the black stone, they cut their own images in their size and likeness, and worshipped them." The apotheosis of self could go no further.

Besides the sun, other symbols were known and, guarded by the priesthood, one of these being the conception of a Trinity in Unity. The Trinities of most sacred significance were never divulged to the people, but the Trinity personifying the cosmic powers of the universe as Creator, Preserver and Destroyer, became publicly known in some irregular manner in Turanian days. This idea was still further materialised and degraded by the Semites into a strictly anthropomorphic Trinity consisting of father, mother and child.

A further development took place in Turanian days. With the practice of sorcery, many became aware of the existence of powerful elementals, called into being, or animated by, their own powerful wills. So degraded had men become, that they actually began to adore these semi-conscious creatures of their own malignant thought. The ritual was blood-stained from the start, every sacrifice giving vitality to these vampire-like creations, some of them becoming thereby so powerful that they persist to this day, continuing to exact their tribute from unoffending village communities.

This blood-stained ritual did not spread to any extent outside the Turanians, though human sacrifice was not uncommon among some of the Semites. In the great Toltec empire of Mexico sun-worship was the national religion, the only offerings to their beneficent Deity, Quetzalcoatl, being flowers and fruit. With the coming of the savage Aztecs, human sacrifices to their war god, Huitzilopochtli, were introduced. The tearing out of the hearts of their victims on the summit of Teocali may be regarded as a survival of the elemental-worship of their Turanian

ancestors in Atlantis.

Amongst the Atlanteans a prominent symbol was the heart, which represented, amongst other things, the atom, which has a pulsation like the beating of the human heart, and also the sun, which they considered had a similar movement, connected with the sun-spot period.

They also thought that the earth itself breathed and moved, and it is true that recently scientists have discovered that there is a regular daily displacement of the earth's surface, which may be thought of as corresponding in a certain way to breathing.

The student is already well aware that the Atlantean Race, being the fourth Root-Race, represents the middle or turning-point of the cycle of descent of spirit into matter; and also that Kâma, desire, reaches its culmination in this Fourth Race. Hence we find that the intensification of Kâma resulted in degraded animal propensities and brutal passions, the slight development of mind, or Manas, serving only to add zest to the gratification of the senses.

Moreover, their sensitiveness to higher things had not yet been completely submerged or drowned by the descent into matter, so that, side by side with the unsavoury characteristics mentioned, we find they had considerable psychic faculties, and godlike intuition.

Save the more advanced few, none had attained to the powers of abstract thought, but the concrete mind was able to function strongly; consequently we see them well advanced in the practical concerns of every-day life, especially when their psychic faculties were directed towards the same objectives.

Gradually, of course, their psychic faculties were lost, and they descended deep into selfishness and materialism.

Although earlier races had begun to fight with one another, it was the Atlanteans who first developed organised warfare. In fact the principle of strife was the fundamental characteristic of the fourth Root-Race, and all through the Atlantean period war on land and sea was the order of the day. So deeply rooted in man's nature did the principle of strife become, that even now the most intellectually developed of the Aryan (fifth) Root-Race are ready to war upon each other.

The fact that Kings and Emperors consider it necessary or appropriate, on state occasions, to appear in the uniform of one of the fighting services, is a significant indication of the apotheosis reached by the combative qualities in man.

The sacred word of the Atlantean Race was Tau, just as that of the fifth or Aryan Race is Om. It is said that the sacred words given to the Root-Races in succession are consecutive syllables of one great word which is the true sacred Name.

There still exists to-day an occult Lodge for occult study preliminary to Initiation, founded originally in Atlantis by Adepts; it observes the same old-world ritual, even teaching as a sacred and hidden language the same Atlantean tongue used so many thousands of years ago. It was the chiefs of this Lodge who

founded the modern spiritualistic movement. For an account of this, the student is referred to *The Astral Plane*, p. 100, or *The Astral Body*, p. 191.

CHAPTER XXXIX

ANCIENT PERU: A TOLTEC REMNANT:

12,000 B.C.

THE civilisation of Peru, about 12,000 B.C., closely resembled that of the Toltec Empire at its zenith, and was in fact an attempt to revive, though, of course, on a much smaller scale, the original Toltec civilisation. We may therefore describe certain features of the Peruvian system as an example of Atlantean civilisation. This account is much condensed from *Man Whence How and Whither*, pp. 141-200.

Government was autocratic, for the Ruler - either the Manu Himself, or His Lieutenant, some Adept from a far higher evolution - was the only person who really knew anything, so that he had to take control of everything. The keynote of the system was responsibility; an avoidable evil, such as the inability of a man to find suitable work, or the illness of a child and the absence of proper attention, was regarded as a slur upon the administration, a blot upon the reign, a stain upon the personal honour of the king.

The Empire was divided into provinces, these being subdivided into cities or smaller districts, these into groups of 100 families, and these again into groups of ten families, suitable responsible officials being in charge of each unit, the honour of an official being involved in the perfect contentment and well-being of everyone within his jurisdiction. Vigilance and attention to duty were ensured not by outer law but by the universal feeling among the governing class" a feeling akin to the honour of a gentleman. Anyone who neglected his duty would be considered an uncivilised being, and regarded with horror and pity much in the way mediæval Europe regarded an excommunicated person.

Living under such conditions, laws were almost unnecessary, and there were no prisons. Every citizen looked upon his life in the Empire as the only life worth living. If a man fell short of his duty, the officer in charge would reprimand him; continued neglect led to the only punishment - exile.

The officials were known as "Fathers"; there was practically no law for them to administer, but they arbitrated in case of disputes. Officials were easily accessible, and made periodical tours through their domains so that they could see for themselves that all was well, and in order that anyone could consult them or appeal to them, if he so desired.

Births, marriages and deaths were registered with scrupulous accuracy, and statistics compiled from them. Each Centurion recorded on a small tablet - the ancestor of the modern "card" system - the name of every person in his charge, and the principal events in his life.

Land was not only carefully surveyed and parcelled out, but

its composition was analysed in order to put it to the best use. The land system was practically that described in Chapter XXXVIII. Every town or village was allotted an amount of land proportionate to the number of its inhabitants. Half the produce was for the cultivators and their families, in proportion to the number of mouths to be fed, half for the community. The government was always ready to buy surplus grain which it stored in huge granaries, in case of famine or other emergency.

Of the half share belonging to the community, one-half, *i.e.*, one-quarter of the whole, was considered the land of the Sun, and had to be cultivated first. Then a man was free to cultivate his own land; last came the quarter share belonging to the King. The same order of precedence applied to irrigation.

A similar division of produce was made in the case of manufactures and mineral products.

From his share the King maintained the entire government, paying their salaries and expenses. He also built and maintained all public works, such as roads, bridges, aqueducts, and the granaries which stored sufficient food for two years for the whole population. He also maintained the army.

With the produce of the land of the Sun the priests maintained the splendid temples of the Sun all over the land, with a magnificence which has never been approached elsewhere on earth. They provided free education to the entire youth of the Empire, including technical training up to the age of twenty, or even later. They also took complete charge of, and maintained, every sick person, who thus became a "guest of the Sun." If the sick man were the breadwinner, his dependents also became "guests of the Sun," until the man recovered. Lastly, the priests provided full maintenance for all over the age of forty-five except the official class.

Officials and priests did not retire at the age of forty-five, except in case of illness. It was considered that their wisdom and experience were too valuable not to be utilised; so in most cases they died in harness.

The reason for the land of the Sun having precedence in cultivation and irrigation is now obvious; for on the produce of that land depended religion, education and the care of the sick and aged.

The whole system worked so admirably that poverty was unknown, destitution was impossible, crime was practically non-existent. Exile was the worst punishment; barbaric tribes from the outside became absorbed into the system as soon as they could be brought to understand it.

They worshipped the Sun, but regarded the physical sun as a symbol of that from which everything came.

They did not seem to have any clear idea of reincarnation, but were certain man was immortal, and held that he returned to the Spirit of the Sun. Their religion was essentially joyous, grief or sorrow being held to be wicked and ungrateful. Death was regarded as an occasion for solemn and reverent joy. Suicide was looked upon with the utmost horror, as an act of grossest

presumption, and was almost unknown.

In their public services praise, but never prayer, was offered daily to the Spirit of the Sun. Fruit and flowers were offered as tokens of what they owed to the Spirit of the Sun. Sermons were simple, picture and parable being largely used. The people were taught that what the Sun did for their bodies, He did also for their souls, both actions being continuous. Men should aim at being perfectly healthy, physically and morally, thus becoming themselves minor suns, radiating out strength, life and happiness. They had accurate knowledge of the radiation of superfluous vitality from a man in good health.

Reading, writing and a kind of arithmetic, were taught, as well as a sort of a rough and ready knowledge of all the general rules and common interests of life, so that every child of ten or eleven had some idea of how the necessaries of life were obtained and how any common work was done. The utmost kindness and affection prevailed between teachers and children.

School hours were long, but the occupations were so various that there was no undue fatigue. Every child was taught how to cook, how to distinguish poisonous from wholesome fruits, how to find food and shelter in a forest, how to use simple tools in woodwork, building or agriculture, how to find the way by sun and stars, how to manage a canoe, as well as to swim, climb and jump with amazing dexterity.

They were instructed in first aid and in the use of herbal remedies. The whole of the instruction was practical, so that the children became thoroughly "handy" and competent.

Whilst they were taught the constitution of their country, and the reasons for customs and regulations, yet they knew no language but their own; this they spoke with great accuracy and purity, through practice rather than grammatical rules. They knew nothing of algebra, geometry or history, nor anything of geography save that of their own country. They knew nothing of chemistry, but much of practical hygiene.

About the age of twelve a definite career was selected for each child, and he was drafted into a suitable technical school, where he remained for a further nine or ten years. Again, they learnt far more by practice than by theory.

Every child had the opportunity of being trained for joining the governing classes, but the training was severe and the qualifications so high that the number of applicants was never unduly large.

The principal pursuit was scientific agriculture, but there were also manufactures, metal working, making machinery, and architecture.

The Agricultural Department carried out extensive and exhaustive researches, and kept careful records of all results, epitomising these in short maxims for popular use. Invention and discovery were well rewarded by the Government, the State being always willing to finance and carry out any tests required. Their sewage disposal methods were quite as effective as anything we have to-day.

Their machinery was rougher and simpler, and less accurately fitted than ours, but it was effective, and not liable to get out of order. Many machines were worked by hydraulic pressure, especially those used for irrigation. Much of the hilly land was laid out in terraces for purposes of cultivation.

Their knowledge of botany was extensive, but again severely practical; they sought to know only the uses of plants in medicine, as food, or to make dyes.

Similarly with chemistry; of atoms and molecules they knew nothing, but they knew a great deal of the practical uses of substances, for manure, manufacturing processes and the like.

Astronomy was regarded as a religious rather than a secular subject. Their knowledge of it was not great, but accurate so far as it went. They knew the difference between planets and stars, the shape of the earth, its rotation and the cause of the seasons. Comets they looked upon as messengers from other great Beings to their Lord the Sun.

Eclipses of sun and moon they could predict with accuracy by means of a traditional formula. The exact moment of noon they ascertained by observation of shadows, and by the same method they found the date of summer and winter solstices, in connection with which they held special religious services.

Their architecture was colossal, but unpretentious; designed for use rather than show, their buildings being what we should consider out of proportion. Such pillars as they used were massive and often monolithic.

They did not seem to use the arch proper, though they constructed openings with semicircular tops, built on heavy semicircular metal plates; but they depended for strength chiefly on their powerful adhesive cement. This was poured in hot and solidified like flint, being stronger than the stone itself. They cut and fitted enormous blocks of stone with the greatest accuracy, so that the joint was barely perceptible; nevertheless they managed to pour cement into the joints.

The majority of houses were built of large blocks of clay treated chemically in such a way that they became scarcely inferior to stone.

The walls were of enormous thickness, and the houses were built round a central courtyard. Very little exterior ornamentation was used.

The entrance was always at a corner, the door being a huge slab of stone, sometimes elaborately carved; raised and lowered by means of counterweights, like a modern sash-window. Later, metal plates were used instead of stone slabs. In a few cases heavy doors were fitted, turning on pivots.

Larger houses were more ornamented; both by carving and by the use of broad bands of metal. So massive were they that they were practically everlasting. Roofs were mostly heavy and nearly flat, of stone or metal sheets. Wood was scarcely used at all in their houses, because of the danger of fire.

No scaffolding was used, but earth was piled up level with the walls, the roof stones being laid on the earth, cement poured

in and allowed to set, after which the earth was removed, leaving a building which was practically monolithic.

Nearly all houses were of one storey only, though sometimes a curious erection was made in tiers, commencing with a platform, say, 1,000 feet square, and diminishing until the tenth tier was 100 feet square, a small shrine to the Sun being built on this final platform. The effect was thus of a flat pyramid rising by broad shallow steps. Rooms were hollowed out of each terrace, and a tunnel into the centre of the lowest tier led to subterranean chambers used for storing grain and other necessaries.

The temples of the Sun were large and massive, but, by modern standards, too low for their length. The interiors were frequently literally lined with gold and silver, the metal plates being as much as a quarter of an inch thick, and yet moulded over delicate reliefs in the stone.

All houses, except the very poorest, were lined inside with metal sheets, much as we now paper our houses. Palaces of the King and chief Governors were, like the temples, lined with pure gold: for other people, beautiful alloys were used, rich effects being obtained at low cost.

Round the boundaries of the empire was built a chain of fortresses; the height and thickness of the walls was enormous, and they tapered upwards. Within the thickness of the walls were chambers and secret passages, fully provisioned to stand prolonged siege without discomfort.

Roads were built on a colossal scale, with splendid disregard of natural difficulties. The whole road was paved with flat slabs, trees and odoriferous shrubs being planted along the sides. Bridges were built on the cantilever principle, i.e., by making each course of masonry project beyond the course below. Knowing nothing of coffer-clams or caissons, they would divert a river, or build a breakwater, in order to construct their bridges. Hence they preferred embankment work to bridging.

They had a wonderfully perfect system of irrigation, their roads and aqueducts being probably the greatest engineering feats the world has known. All the work was done by paid peasantry, or by the army.

Weapons being simple, and little drill being required, the army was mostly employed on public works and services. It supplied all the runners for despatches and letters, official and private. It maintained all public works. but called in additional labour for new works.

In their infrequent wars with less civilised tribes, their motto was: "You should never be cruel to your enemy, because tomorrow he will be your friend." They slew as little as possible, and endeavoured to make it possible for other tribes to come into the Empire. They used the spear, the sword, and the bow, as well as the bolas, which consisted of two stone or metal balls joined by a rope, and so thrown as to entangle the legs of man or horse and bring him to the ground. Their forts were arranged so that they could roll great rocks on to their assailants.

They used iron, but did not know how to make steel. More

valuable to them were copper and various brasses and bronzes, because these could be made exceedingly hard by alloying them with their remarkable cement; thus treated, even pure copper would take an edge as fine as our best steel, while some of their alloys were harder than any metal we have to-day. Iron did not blend so perfectly with the cement and consequently was not so useful.

Their metal work was exceedingly fine and delicate, some of the filigree-work being so gossamer-like that it had to be cleaned by means of a blow-pipe, as ordinary rubbing or dusting would have destroyed it. Some of their engraving was almost too fine to be seen by, at any rate, our modern eyes.

Pottery they made from clay, chemically treated, so that it became a rich crimson colour; they then inlaid it with gold and silver, with exceeding delicacy of line. Other fine colours also were obtained, and by mixing the clay with their cement they obtained a transparency almost equal to our clearest glass, and far less brittle. They could also make thin porcelain which would bend without breaking.

Metal-work and pottery to a great extent replaced wood, of which they made very little use.

Painting was practised to a considerable extent, but it was done on sheets of silicious material, with a delicate, creamy surface. These could be bent, and varied in thickness from that of notepaper to that of stout millboard.

Paint-brushes consisted of lengths of a fibrous plant, with the end beaten out and cut to a sharp triangle, so that it could be used for the finest as well as the thickest lines.

Colours were usually in powder, mixed with some vehicle which dried instantly, so that a touch once laid could not be altered. The colours surpassed in delicacy and purity any now employed. By using the dust of metals they obtained a rich effect, though perhaps to our tastes somewhat barbaric.

Perspective was good, and the drawing accurate. The completed picture was brushed over with a very quick-drying varnish, which made it practically indelible and impervious to sun or rain for a long time.

Books were written, or rather illuminated, on the same material and in the same manner as pictures. They consisted of a number of thin sheets, usually about 18 by 6 inches, strung together by wire or kept in a box 3 to 5 inches deep. The boxes were usually made of a metal resembling platinum, more or less richly ornamented.

Printing does not seem to have been known, though a kind of stencil-plate was used for multigraphing official notices and the like. Their attitude to books was much that of the mediæval monk, and to make a copy of one was a work of merit.

The range of their literature was limited. There were a few religious or ethical treatises, and some mystical, but the favourites were those more directly practical. There was a mystical book closely resembling the Chinese *Classic of Purity*.

Official treatises or manuals existed for every trade,

handicraft or art, and were kept up to date by appendices. Thus the Peruvian monograph on any subject was a compendium of useful knowledge, giving in condensed form all that was known on the subject.

There was also a class of story-book with a moral purpose, usually describing how a King or other official dealt with an emergency. Many of these were classics, constantly quoted. They were accepted as true, though some of them may possibly have been fiction.

Some of the stories had plenty of wild adventure, but there were no love stories. Some of the stories contained humour, though the professedly comic story had not yet been created. There was also no poetry, although maxims couched in swinging, sonorous speech, were widely known and constantly quoted.

In their music they had a pipe and a kind of harp, but their favourite was something like a harmonium. The keyboard was similar to that of a typewriter, an ingenious mechanical arrangement forcing wind against a vibrating tongue of metal to produce sounds.

The Peruvian musical scale was that of the Atlanteans, but very different from our own. They had no set pieces, but each performer improvised for himself.

Their sculpture was bold, dashing and effective rather than graceful. Their rugged statues were of colossal size. Fine work was done in bas-relief, usually covered with metal.

Minors were not allowed to marry, but adults were expected to do so unless there was good reason to the contrary. All marriages were performed on one day in the year, the Governor, after asking a few questions, going through a simple form, and pronouncing the couples man and wife. A new assignment of land was then made to suit the changed circumstances.

The flesh of animals was not eaten; they consumed the potato, yam, maize, rice and milk. Their principal food was composed of maize-flour, mixed with other chemical constituents, and reduced by enormous pressure to a highly concentrated cake. Its components were such that it was a complete food in itself. A man could therefore carry food for a long journey without inconvenience.

It was sucked slowly like a lozenge, or boiled or cooked in various ways. Having little flavour of its own, it was flavoured by pomegranate, vanilla, orange, guava, and so on.

It was manufactured in enormous quantities, and was very cheap. Many people ate scarcely anything else, though there were plenty of other foods available.

They were fond of pet animals, small monkeys and cats being the favourites, these being bred in many fancy varieties. With cats, they made a speciality of colour, and had produced a decided and brilliant blue type.

Many were fond of birds also, and it is possible that to them we owe some of the brilliantly coloured specimens in the Amazon forests. Some of the richer ladies had huge aviaries with golden wires, and devoted much time to cultivate the affection

and intelligence of their pets.

The national dress was a loose flowing garment, simple and scanty, usually brightly coloured. A Peruvian crowd on a festal occasion was a brilliant sight. Women usually preferred blue robes, often of the shape assigned to the Virgin Mary by mediæval painters. The material was usually cotton, though the fine wool of the llama and vicuna also was used. A cloth of great strength was made from the threads of the maguey, chemically treated in some way.

For calculation they used an abacus, or calculating frame, like the modern Japanese. A cheaper substitute was a fringe of knotted cord, possibly the original of the *quipus*, which the Spaniards found in use thousands of years later.

Speaking generally, their physical life was undoubtedly better managed than anything we have known since. The opportunities for unselfish work and devotion to duty, which were offered to the governing class, have perhaps never been surpassed. But no mental struggle or effort was necessary for the less intelligent classes, though any expression of these was richly rewarded.

The condition of public opinion then was higher, and the sense of duty stronger, than it is now. But it must be remembered that the race we have been examining was an offshoot of a race that had long passed its prime. We are yet a comparatively young race and should, in due time, reach a level even higher than that of the Atlanteans.

The Atlanteans had nothing which could be called Occultism, nor any grasp of the great scheme of the universe such as that which modern Theosophy presents to us. Hence, when our Fifth Root Race reaches the same stage of its life, our physical conditions should be as good as those of the Atlanteans and our intellectual and spiritual development should be higher than anything that was possible to the Peruvian relic of Atlantis, 14,000 years ago.

CHAPTER XL

THE FOURTH ATLANTEAN SUB-RACE: THE TURANIAN

THE Turanian or fourth sub-race arose on the eastern side of the continent, south of the mountains inhabited by the Tlavatlis. Most of them lived in the centre of Atlantis, west and south of the Tlavatli area, but these lands they shared with the Toltecs.

They were never a thoroughly dominant race on the mother-continent, though some of their tribes and family races became fairly powerful. They were always colonists, many migrating to the east.

In the period 800,000 to 200,000 years ago, they lived further south, occupying the country where Morocco and Algeria now are. They occupied also both the east and west coasts of the Central Asian sea. Some moved still further east, the inland Chinese being to-day the nearest approximation to them. A small branch of them became the brutal Aztecs, who conquered and replaced the last great empire that the Toltecs raised.

They developed a sort of feudal system, each chief being supreme in his own territory, the king being merely *primus inter pares*. Sometimes the council murdered their king and replaced him by one of themselves.

They were thus turbulent, lawless, brutal and cruel. At some periods regiments of women took part in their wars.

Being continually defeated in war by the Toltecs, who greatly outnumbered them, and desiring increase of population, every man was by law relieved from the direct burden of maintaining his family, the State regarding all children as its property, and therefore providing for them. This led to increase of the birth-rate, and disregard of the marriage ceremony. The ties of family life and parental love were destroyed, and the scheme was then given up, having proved a failure. They tried also, and abandoned, other socialistic solutions of economic problems.

The Turanians were the first of the four later "yellow" sub-races.

They used the Tlavatli tongue as a basis, but so modified it as to produce eventually an entirely different language.

At one time they experimented in democracy, carrying it to even wilder lengths than its most rabid advocates to-day have suggested. The results were so intolerable that the whole race broke up into anarchy and chaos. China even now bears the impress of the violent reaction towards aristocratic government which followed.

The Turanians had very strongly developed animal passions, and in many ways were not pleasant people.

CHAPTER XLI

A TURANIAN RELIC: CHALDÆA, 19,000 B.C.

A NATION of Turanian stock lived in Chaldæa about 30,000 B.C., as a number of petty, quarrelling tribes, living by primitive agriculture, and knowing little of architecture or culture of any sort.

To them came a leader from the East, one Theodorus, sent as Governor by the Manu. From Theodorus descended the royal line of ancient Chaldæa, a line differing widely in appearance from their subjects, being strong-faced, with bronzed complexion and deep-set gleaming eyes. A fair idea of this royal type may be obtained from later Babylonian sculptures, though by that time Âryan blood had permeated almost the entire race.

The civilisation which ensued was as remarkable as that of Peru, in 14,000 B.C., though entirely different. In Chaldæa the system of government was in no way exceptional; the emphasis was on religion, which permeated and dominated the life of the people to an extent equalled perhaps only among the Brâhmans of India.

The faith of Chaldæa was stern and mystical, with a complicated ritual for the worship of the great Star-Angels, or Planetary Logoi, as we should call them, and including a comprehensive and carefully worked-out system of Astrology.

Their idea of astrology was practically identical with that taught in modern Theosophy, based on the principles briefly indicated in Chapter XVI of this book. The theory given to the priests was probably handed down to them through unbroken tradition from Teachers who had first-hand knowledge of the great facts of nature, and it was exceedingly elaborate and mathematical.

They regarded the solar system as one great Being, all its physical components being His physical expression, its astral components collectively His astral expression, and so on.

Each and every class of matter was composed of material belonging to the seven great types or Rays, as explained in Chapter XVI. The Chaldæans held that the whole mass of what we now call elemental essence of any one of those seven types formed to some extent a separate vehicle, almost a separate entity. Since every man has within himself matter of all the seven types, it followed that any modification in, or action of, any one of the great centres controlling the matter of that particular type, would affect him, to a degree dependent upon the amount of matter of that type which he possessed.

Each of the seven great centres in the solar system has its own enormous sphere of influence; it also has certain orderly periodic changes of its own, like the beating of a heart. These periodic changes being of different rates, a complicated series of effects is produced, and it has been observed that the movement of the physical planets furnishes a clue to the

arrangement of the great sphere of influence at any given moment. The Chaldæans held that the intersection of these spheres of influence formed vortices which determined the location of the physical planets.

Whilst recognising that these various influences profoundly affected men, yet the Chaldæan priests were far from being fatalists. They held that the influences could not in the slightest degree dominate the will of man, but could only make it easier or more difficult, as the case might be, for him to act along certain lines. A really strong man had little need to trouble himself as to the influences which happened to be in the ascendant, but most ordinary people would do well to consider at what moment this or that influence could most advantageously be applied.

The influences themselves are no more either good or evil than is electricity, but a wise man would, in his electrical work, take into account the electrical condition of the atmosphere and select a time when this was most favourable to what he wished to do.

Thus, to take a simple example: the influence of Mars was held to affect astral matter in the direction of passion, so that when Martian influences were especially strong, he would be more *likely* to have passion quickened or intensified in him. Another influence would intensify nervous excitement, and at such times disputes would be more than usually likely to arise, and people would be more inclined to lose their tempers on less than ordinary provocation.

The priests calculated the position and action of the spheres of influence, as a guide to practical life. With prediction they did not concern themselves. For each year they drew up a sort of official almanac, by which the whole life of the race was largely regulated. They decided the best times for agricultural operations, for the breeding of plants or animals, for the administration of remedies, and so on.

Their followers were divided into classes, according to what modern astrologers call their "ruling planet." The calendars would contain such warnings as: "On the seventh day, those who worship Mars should be on the watch especially against irritation"; or: "From the twelfth to the fifteenth days there is unusual danger of rashness in matters connected with the affections, especially for the worshippers of Venus," and so on.

Certain daily hours of prayer, regulated by the apparent movements of the sun, were observed by all alike. At sunrise, noon and sunset, certain anthems or verses were chanted by the priests at the temples: those who were able to do so attended the temples at those times; others recited a few phrases of prayer or praise.

Apart from these observances, common to all, each person had his special prayers to the particular Deity to whom by birth he was attached. The proper time for them varied with the motion of the planet; the most favourable was that when the planet crossed the meridian, and next to that came the times of its rising and

its setting. But it could be invoked any time it was above the horizon, and, in emergency, even when it was below the horizon, though then by an entirely different ceremonial.

What may be called special calendars or periodical prayer-books were issued for each planet, and every person was careful to possess the one appropriate to himself. These calendars were considered also to possess various talismanic properties, so that the people carried them about with them.

At whatever hour the time for religious meditation or exercise arrived, however inconvenient, each devotee observed it faithfully, taking the view that at such a time it would be foolish and ungrateful not to take advantage of the special blessing his particular Deity, was then pouring out.

Gorgeous public ceremonies also were held, each planet having at least two great feast days in the year, the Sun and Moon considerably more than two. Each planetary Spirit had his temples in every part of the country, to which the devotees of that planet repaired; but for the greater festivals vast multitudes assembled at the unique group of magnificent temples near their capital city.

These temples were arranged so as to represent, on suitable scales, the proportionate sizes of the planets and their distances from the sun. The temples differed in design, every variation presumably having its special significance. Each of them, however, possessed a brilliantly coloured hemispherical dome, the diameter proportionate to the size of the planet concerned.

The place in the scheme where the earth should have been represented was occupied by the temple of the Moon. Close by, there was an isolated dome of black marble supported by pillars, typifying the Earth, but containing no shrine.

In the space, correctly calculated, between Mars and Jupiter, there was no temple, but instead a number of columns; each ending in a tiny hemispherical dome; these presumably represented the asteroids. Satellites were indicated by correctly proportioned subsidiary domes, and Saturn's rings were also clearly shown.

On the principal festivals of any given planet the devotees of that planet wore brilliantly coloured mantles or copes of the colour sacred to the planet. The colours were as follows:

The Sun: delicate silken material, interwoven with gold threads, like cloth of gold, but as flexible as muslin.

Vulcan: flame-colour, very striking and gorgeous.

Mercury: brilliant orange, shot with lemon-colour.

Venus: pure sky-blue with an underlying thread of light green, giving a quivering iridescent effect.

Moon: white, interwoven with threads of silver, which in certain lights showed pale violet shades.

Mars: brilliant scarlet with a strong crimson shade underlying it and, in certain lights, showing as the predominant colour.

Jupiter: gleaming blue-violet dappled with tiny silvery

specks.

Saturn: sunset green, with pearl-grey shades underlying it.

Uranus: deep rich blue - the colour of the South Atlantic.

Neptune: plain-looking dark indigo, though unexpectedly rich in high lights.

The devotees; thus arrayed, marched in procession to the temples, decked with garlands of flowers, bearing banners and gilded staves, sonorously chanting.

The Sun-God feasts afforded the grandest display, the whole multitude, each person arrayed in his own planet's colour, performing the solemn circumambulation of the Sun-Temple, the followers of each planet forming a concentric ring in its appropriate place relative to the Sun-temple in the centre.

The temple of the Sun was built according to Diagram XLIII, which is practically self-explanatory. The immense

concave mirror behind the main altar was of metal, probably silver, very highly polished, it being considered a religious duty to keep it bright and free from dust. Along the line marked SS was a narrow slit in the roof, so that the light from a star exactly on the meridian fell upon the mirror; and was brought to a focus at the spot where the brazier is shewn. Incense being thrown on

the brazier, the image of the star gleamed in the light grey smoke. The worshippers bowed their heads and the priests chanted, reminding one of the elevation of the Host in a Catholic church.

Sometimes a flat mirror; suspended above the brazier, would be lowered to the focal point of the concave mirror, so as to catch the image of the planet and reflect it upon a certain spot on the floor of the temple. On that spot were laid the sick for whom that particular influence was considered beneficial. Diagram XLIV illustrates the arrangement in outline.

On the western altar burnt always what was called the "sacred Moon-fire," which was allowed to go out only on the night before the spring equinox. The following morning the rays of the Sun, passing through an orifice above the eastern altar, fell upon and were concentrated by a glass globe filled with water, the Sun himself thus relighting the sacred Moon-fire, which was kept burning for another year.

The inside of the dome was painted to represent the night-sky, complicated mechanism causing the principal constellations to move over it exactly as the real stars move. The planets were

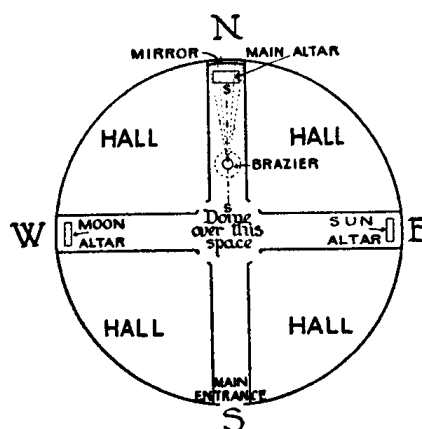

DIAGRAM XLIII.—Plan of Chaldean Temple.

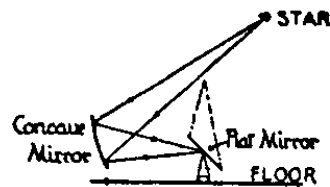

DIAGRAM XLIV. — Arrangement of Mirrors in the Chaldean Temple.

represented by luminous bodies, which originally were materialisations produced by the Adept Teachers, and which moved freely in the air. Later these were replaced by ingenious mechanical contrivances.

The outside of the dome was thinly plated with gold, with a peculiar dappled effect evidently intended to represent the "willow-leaves" or "rice-grains" of the Sun.

Beneath the temple was a crypt, used exclusively by the priests for meditation and self-development. Light, reflected when necessary, was admitted only through thick plates of a crystal-like substance of various colours, and directed on to the various chakrams or centres in the body, thus aiding in the development of the power of divination, clairvoyance and intuition.

A hollow rod, or thyrsus, charged with electric or vital fire, also was used here, as in the Grecian Mysteries.

To the Chaldæans, the title "the Spirit of a planet" included three different conceptions. First, what we may call the "planetary elemental," an undeveloped, semi-intelligent yet exceedingly potent entity, consisting of the collective elemental essence of the planet, regarded as one huge creature, corresponding to what in man's astral body we call the desire-elemental. It was the influence, or magnetism, of the planetary elemental which they tried to focus on to a sick person, or to imprison in a talisman.

Secondly, the Spirit of a planet represented that one of the ten types of essence which poured through that planet, regarded as a centre in the body of the Logos Himself. In this sense the Spirit of the planet was omnipresent throughout the solar system, working in each man, through certain plants, minerals, etc., and giving them their distinctive properties. It was this Spirit of the planet in a man to which their astrological warnings referred.

Thirdly, they regarded the Spirit of a planet as the Head of a whole hierarchy of spirits, Who was pre-eminently *The Spirit of the planet*, or the Star-Angel. He was regarded by them much as a Christian regards the great Archangels, the "seven Spirits before the throne of God," as a mighty minister of the divine power of the Logos. It was said that when the image of a Star was reflected in the incense-cloud, clairvoyants could see the form of the Star-Angel, the image of the star shining upon His forehead.

One of their tenets was that in rare cases it was possible for a man, through meditation and devotion, to secure his next birth on the planet of the Star-Angel whom he worshipped, and the temple records contained accounts of this having been done. Once or twice in history, they said, the same thing has been done with a still greater order of stellar Deities, belonging to fixed stars outside the solar system altogether.

The term "worship" is perhaps a little misleading, when speaking of the Chaldæans. The feeling was rather the deep affection, veneration and loyalty which we to-day feel towards

the Masters of Wisdom.

Their religion evidently meant a great deal to the Chaldæans. The priests were men of great learning along their own lines. They studied history and astronomy profoundly, blending the two sciences into one. They were fairly well versed in chemistry, and used some of its effects in their ceremonies. A priest, for example, would make the astrological sign for a planet with some brilliantly phosphorescent substance on the pavement in front of him.

Some priests specialised in medicine, studying the properties of drugs when prepared under certain stellar influences; others studied agriculture, the composition of soil and its improvement, the use of coloured lights for plants, and so on. Others again constituted a weather bureau, foretelling with accuracy storms, cyclones, or cloud-bursts. Later this became a Government Department, priests who predicted inaccurately being deposed.

Very great importance was attached to pre-natal influences, a mother being directed to live a sort of semi-monastic life both before and after the birth of a child.

The priests were not responsible for education, although they decided, by calculation, and sometimes by clairvoyance, to which planet a child belonged. Each planet had its own school, both for scholars and teachers, the training for each type differing considerably, the intention in each being to develop the good qualities and counteract the weaknesses characteristic of each type.

Imparting knowledge was quite secondary, the primary object being the formation of character. The hieroglyphic script, and elementary calculation, were taught to every child, but nothing else that we should recognise as a school subject. Religious or ethical precepts were learnt by heart, indicating the conduct expected from a "son of Mars," a "daughter of Venus," and so on, the only literature being an endless commentary upon these, the children being taught to criticise the actions of the heroes in the stories.

Many years were thus spent in familiarising themselves, theoretically and practically, with the teachings of this unwieldy *Book of Duty*, as it was called, the children being expected to impersonate the various characters in the stories, acting as in a theatre.

The school curriculum did not comprise history, mathematics, agriculture, chemistry or medicine, though any young man, on leaving school, could attach himself as an apprentice to a priest who specialised in any of these subjects.

Literature was not extensive. Official records were kept with great care, transfers of land were registered, and the decrees of the Kings were filed for reference. But no connected history was compiled. It was taught orally, and episodes were tabulated and related to astronomical cycles.

Poetry, handed down orally, was represented by a series of sacred books, giving a highly symbolical account of the origin of

the worlds and mankind, and also by ballads celebrating the deeds of legendary heroes.

After a long period of splendour and prosperity, the mighty Empire of Chaldæa slowly waned and decayed, until it was utterly destroyed by hordes of fanatical barbarians who, with puritanical fervour, destroyed every trace of the temples. The spoilers were in their turn driven out by the Akkads, members of the sixth sub-race, from the north. These, coalescing with the remnants of the old race and other Turanian tribes, made the Sumiro-Akkad nation out of which the later Babylonian Empire developed.

This became more and more affected by admixture of Âryan blood, first from the Arabian, or Semitic, and then from the Iranian sub-races, until, in what we call historical times, there was scarcely any Turanian left in the faces of the sculptures and mosaics of Assyria.

This later race endeavoured to reproduce the worship of the past, of which it still had tradition, but succeeded in producing only a pale and distorted copy of the original magnificent cult of the Star-Angels.

Looking at such civilisations as those of Chaldæa and Peru, in which whole nations lived a happy and religious life, free from intemperance and from grinding poverty, it might be thought that humanity, since then, has not evolved but retrogressed. Progress, however, is subject to a law of cyclic change, and under that law personalities, races, empires and worlds pass away, all forms, however beautiful, perishing, in order that the life within them may grow and expand. The Fifth Race, when it attains the zenith of its growth, should reach to a height even loftier than that attained by the Atlantean Race.

For further details of the Chaldæan civilisation the student is referred to *Man Whence How and Whither*, pp. 201-238, from which this chapter has been condensed.

CHAPTER XLII

THE FIFTH ATLANTEAN SUB-RACE: THE ORIGINAL SEMITES

THE fifth sub-race, or Original Semites, rose in the mountainous country now represented by Scotland, Ireland and some of the surrounding seas. In this least desirable portion of Atlantis they grew and flourished, maintaining their independence against aggressive southern kings, till the time came for them to spread abroad and colonise.

They were turbulent and discontented, always at war with their neighbours, especially with the growing power of the sub-race that followed them - the Akkadians.

They leant towards a patriarchal form of government, their colonists, mostly nomadic, almost exclusively adopting this form. Nevertheless; in the period 800,000 to 200,000 years ago, they developed a considerable empire, and even possessed the City of the Golden Gates. Ultimately they had to give way to the Akkadians, the final overthrow being about 100,000 years ago.

During the period 800,000 to 200,000 years ago, they spread both west and east: west to what is now the United States of America; thus accounting for the Semitic type found in some of the Indian races; and east to the northern shores of the continent which combined all there was then of Europe, Africa and Asia. The ancient Egyptians, and other neighbouring nations, were to some extent modified by Semitic blood. With the exception of the Jews, the only representatives of comparatively unmixed blood at the present day are the lightly coloured Kabyles of the Algerian mountains.

In addition to these normal emigrations, a special emigration was arranged by the Manu; this being the fifth sub-race, and therefore especially associated with the development of manas, or mind; from it was chosen the nucleus from which the Fifth Root-Race was to be formed. The tribes resulting from the segregation travelled to the southern shores of the central Asian sea, where the first great Âryan kingdom was established.

The Semites, although the second of the four later "yellow" sub-races, were comparatively white in complexion.

In their language they adopted a Toltec groundwork, but modified it into a language of their own.

CHAPTER XLIII

THE SIXTH ATLANTEAN SUB-RACE: THE AKKADIAN

THE sixth, or Akkadian, sub-race arose, after the great catastrophe 800,000 years ago, in the land east of Atlantis, about where Sardinia is to-day. Soon, however, they overran the now diminished continent of Atlantis. They fought with the Semites both on land and sea, very considerable fleets being used on both sides. About 100,000 years ago they finally vanquished the Semites, setting up a dynasty in the old Semite capital, and ruling the country wisely for several hundred years. They were a great trading, sea-going and colonising people.

They were law-abiding, lived in settled communities, and produced an oligarchical form of government. Like Sparta, in modern times, they had a dual system of two kings reigning in one city. They made great advances both in astronomy and in astrology.

Spreading eastwards, they occupied what later, became the shores of the Levant, reaching as far as Arabia and Persia, and helping to people Egypt. The early Etruscans and Phœnicians, including the Carthaginians and the Shumero-Akkads, were branches of this race, while the Basques of to-day are probably principally of Akkadian origin.

In early Akkadian days, about 100,000 years ago, a colony of Initiates founded Stonehenge, on what was then the Scandinavian part of Europe. The priests and their followers belonged to an early strain of Akkadians, and were taller, fairer and longer-headed than the aborigines of the country, who were of mixed descent, but mostly degenerate descendants of the Rmoahals. The rude simplicity of Stonehenge was intended as a protest against the extravagant ornament and over-decoration of the Atlantean temples of that time, where the inhabitants were worshipping their own images.

The Akkadians, the third of the four later "yellow" sub-races, were yet, like the Semites, comparatively white in colour.

Adopting a Toltec ground-work, they modified that language until they produced one of their own.

All the Atlantean languages were agglutinative. In the Fifth Root-Race the descendants of the Semites and the Akkadians developed inflectional speech.

CHAPTER XLIV

THE SEVENTH ATLANTEAN SUB-RACE: THE MONGOLIAN

THE Mongolian or seventh sub-race seems to have been the only one which had no touch with the mother-continent. It arose on the plains of Tartary in Eastern Siberia about 63° N. Lat. and 140° E. Long. It was directly descended from the Turanian race, which it gradually supplanted over most of Asia. It multiplied exceedingly, so that even at the present day a majority of the earth's inhabitants technically belong to it, though many of its divisions are so deeply coloured with the blood of earlier races as to be scarcely distinguishable from them.

They were a nomadic people, and an improvement on their ancestors of the brutal Turanian stock, being more religious as well as more psychic than the Turanians. The government they adopted required a suzerain in the background who should be supreme both as a territorial ruler and as a chief high priest.

Wide as are the plains of Tartary, Mongol tribes have more than once overflowed from northern Asia into America, across Bearing's Straits. The last of these emigrations, that of the Kitans, some 1,300 years ago, has left traces which have been followed by ethnologists, such as in some tribes of North American Indians. The Hungarians are an offshoot of this race, ennobled by a strain of Aryan blood, whilst the Malays are another offshoot, though degraded by mixture with the effete Lemurians.

The Mongolian is the last Atlantean sub-race in full force to-day, and has, in fact, not yet reached its zenith, the Japanese nation having history still to give to the world.

The Mongolians; like the Turanians, were yellow in colour.

CHAPTER XLV

BEGINNINGS OF THE FIFTH (ÂRYAN) ROOT-RACE

IT was mentioned in Chapter XXXVII that the Manu of the Fifth Root Race, the Lord Vaivasvata, selected a group of egos; including the 1,200-year group, whom He hoped to shape for His Race, and with whom therefore He kept up a connection. This was about 1,000,000 years ago; 400,000 years later He made a further selection of likely candidates.

The first decisive step, however, in founding the Race was about 100,000 years ago; when a tribe of the Atlantean fifth sub-race; the Semites, white in colour, was isolated in the mountains to the north of Ruta. This sub-race was addicted to mountains, the Kabyles of the Atlas Mountains being its best modern representatives.

Their religion was different from that of the Toltecs living in the plains, a fact of which the Manu took advantage to effect the Isolation. Then the Bodhisattva, the future Lord Buddha, founded a new religion; those who came into it were told to keep apart and forbidden to intermarry with other tribes.

The people were told that they were under a King and Lord, physically unknown to them, and that they would be taken away to a "promised land." Some, but not all, of the Hebraic story was probably derived from these facts.

Owing to the impending subdual of the fifth sub-race by the Dark Ruler, the Manu, in 79,797 B.C., shipped His people off through the Sahara Sea and then by land to Arabia. A fleet of thirty ships was provided for the purpose. These were not more than 500 tons; they were clumsy, running before the wind fairly well, but bad at tacking: oars also were used. Three trips were made, and about 9,000 people were brought over, together with some animals which were a sort of mixture of buffalo, elephant and pig, something like a tapir.

Out of the 9,000 people five-sixths were from the fifth sub-race, one-twelfth were Akkadian, and one-twelfth were Toltec, each group the best of its kind.

At this time there was a splendid Toltec civilisation in Egypt and, as the emigrants passed through that country, the Egyptians tried to bribe them to remain. A few succumbed to the temptation, defying the Manu's command, and later became slaves of the Toltecs.

The rest, led by the Manu, reached the Arabian highlands, by way of what is now the route of the Suez canal. The valleys were fertile when irrigated, the country being sparsely populated by a negroid race.

In one of the valleys a large number of the Servers, of the 1,200 and 700 years groups, settled; they were so fanatically devoted to the Manu that they drew upon themselves the anger of the Egyptians, who fought and exterminated them, though

Vaivasvata Manu eventually drove out the Egyptians.

After this the colonists lived in peace for some time, cultivating their land and using various kinds of seeds they had brought from Atlantis. In about 2,000 years they numbered several millions; they were isolated from the world by a belt of sand, the only way across it, with grass and water, being about where Mecca now stands. The least desirable types were sent away as emigrants, one party going to the south of Palestine, another to the south of Egypt. In one of the colonies the horse was developed. Occasionally, in order to improve the human type, the Manu Himself incarnated.

The people were pastoral and agricultural and became so numerous as to cause over-crowding. Accordingly a very large number were sent to Africa to found a colony. This colony was later exterminated.

A few years before the catastrophe of 75,025 B.C., under instructions from the Head of the Hierarchy, the Manu selected some 700 of His own descendants, and made them into an unorthodox and strict sect. He formed them into a caravan and set off northwards (*vide* Diagram XLV). He sought and obtained peaceful passage through the dominions of the Ruler of the Sumiro-Akkad Empire, embracing what are now Turkey in Asia, Persia and the

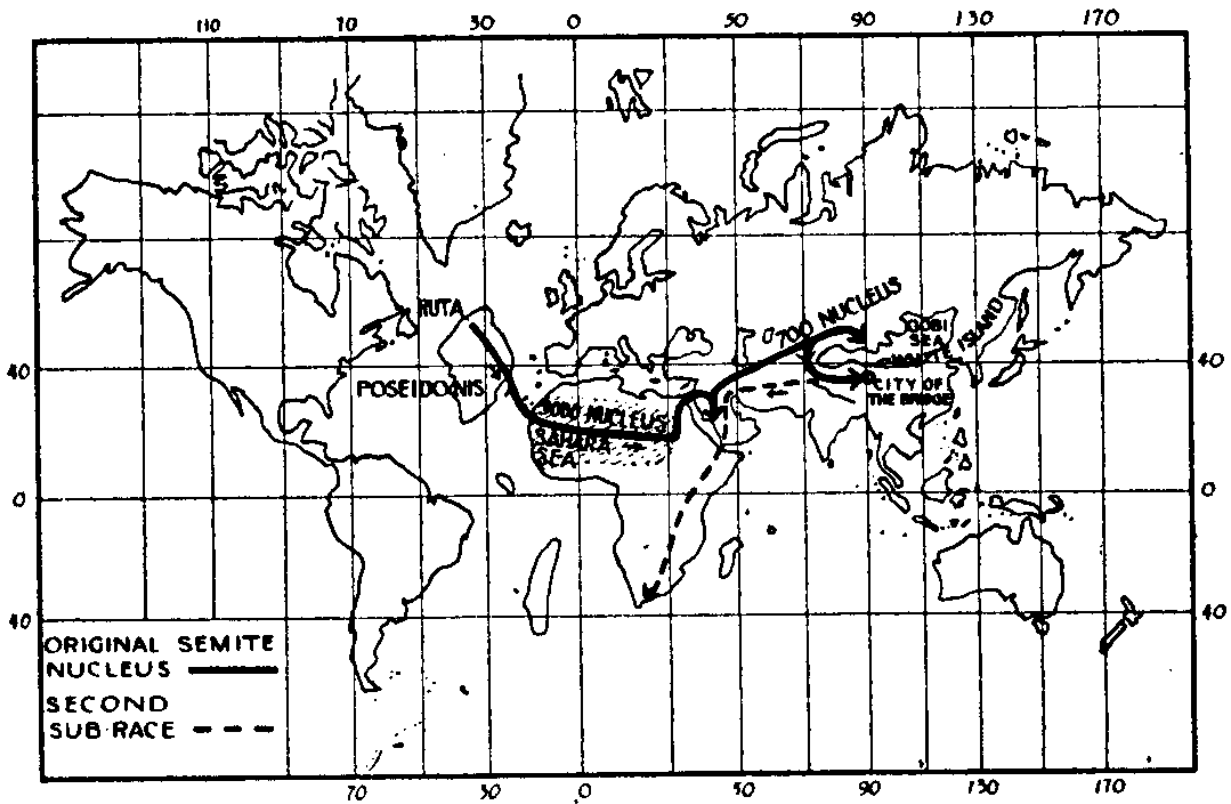

DIAGRAM XLV.—The Fifth Root-Races and the First Migration (Second Sub-Race).

countries beyond. In Turkestan He treated with a Confederation of Turanian feudatory States, including what is now Tibet, and was permitted to pass. After some years the caravan reached the Gobi

Sea; here it turned into the hills to the north, where a great shallow sea stretched northwards to the Pole. At this time the Lemurian Star was much broken up, its nearest point being about 1,000 miles to the north.

The Manu posted some of His followers on a promontory looking to the north-east, but the majority He settled in a fertile, crater-like depression. The White Island was to the south-east, and out of sight until later when, covered with lofty temples, it became visible.

The people remained here until after the great catastrophe, which was then close at hand. The geological formation was such that, unless the whole land was broken up, very little harm would be done by earthquakes. When the seismic changes were in progress, the community was undisturbed by absolute cleavage or change of surface, although the people were terrified by the recurring earthquakes, and almost paralysed by fear that the sun, invisible for a year owing to clouds of fine dust, had gone out for ever. Terrible rains fell incessantly, whilst masses of steam and clouds of dust darkened the air. Nothing would grow properly, and the people were exposed to severe privations. Of the original 700, increased to 1,000, only 300 of the strongest survived.

At the end of five years, they again became settled; the weather became warm, and much virgin soil was thrown up, which they were able to cultivate.

The Manu, by this time an old man, was ordered to bring His people to the White Island. There he was shown the plan of the future, stretching over tens of thousands of years. His people were to live on the shores of the Gobi Sea, to increase and grow strong. The new Race was to be founded on the White Island itself, and a great city was to be built on the opposite shore, the plan of this being suggested.

There was a mountain range running along the shores of the Gobi Sea, some 20 miles distant, and low hills stretched out from that range to the shore. Four valleys; entirely separate from one another, ran down to the sea. The Manu was instructed to plant certain selected families in these valleys and develop from them four separate sub-races, which were then to be sent out to different parts of the world. Some of His own people were to be born in the outer world, and were then to return and marry into His family, in order to improve the racial type. He Himself was then to incarnate and fix the improved type.

Five types were thus to be formed - the original main type and four sub-types.

About 70,000 B.C. the Manu instructed His people to settle and build villages on the mainland. Here they were to live and multiply for some thousands of years. The Manu, the recognised King, resided at Shamballa.

Some years later the Manu instructed Jupiter, Corona (who later became Julius Cæsar), Mars, and Vajra (who later became H. P. Blavatsky) to select certain of the best children and send them to Shamballa. These children were Uranus, Neptune, Sûrya, Brhaspati, Saturn, Vulcan and Venus, all of whom have since

become Masters.

Soon after this the Turanians swept down on the community horde after horde, and eventually annihilated it.

The descendants of the children who had been saved eventually founded another populous and flourishing civilisation, at a higher level than before. Many of the Servers were included; they were often stupid, and made many mistakes, but they were bound closely to those whom they served by loyalty and wholeheartedness.

They built houses of great size, and strongly fortified them, as well as their towns and villages, against the savage Turanians who continually harassed them.

Again they became a small nation, only to be once more massacred by the Turanians, a few children and their nurses being saved and brought up in Shamballa. The Race-type was in this way preserved, the Manu and His lieutenants incarnating in it as soon as possible to bring it nearer to the standard required.

It is noteworthy that even the bloodthirsty Turanians held the White Island in deep veneration, and refrained from attacking it.

Going back for a moment to the people who were left behind in Arabia when the Manu took his selected 700 to Central Asia, we may note that from those left behind were descended the Jews; we shall take up the history of the Jews again in a later chapter.

CHAPTER XLVI

THE CITY OF THE BRIDGE

AFTER the second destruction, described at the end of the preceding chapter, the Manu sent Mars to incarnate in one of the best Toltec families in Poseidonis, and recalled him when twenty-five years old. Mars then married the daughter of the Manu, thus bringing in an additional strain of Toltec blood, which was needed for the Race. From this date, about B.C. 60,000, the Âryan Root-Race may be said to have begun, as a really successful foundation, for after this it was never again destroyed.

The descendants of the Manu remained on the Island until they numbered 100; they then went over to the mainland to begin the building of the City which the Manu had planned as the future capital of His Race.

The city spread out fanwise round the edge of the shore, sloping up to the hills, 20 miles distant; the streets, which were very wide, all pointed towards the White Island. The whole City was thus planned carefully, 1,000 years in advance of the people who were to live in it. From the hills they obtained metals, and stones of various colours - white, grey, red and green, as well as porphyry of a splendid purple. The builders worked gladly, as a brotherhood, knowing that they were carrying out the wishes of Him who was at once their Father and their King.

They used stones larger even than those at Karnac, slinging them on rollers with the aid of machinery, some of the stones being 160 feet long. The Manu and His lieutenants lightened the stones by occult power so that they could be lifted into their places. The buildings were on the Egyptian scale, but much lighter in appearance. This was especially so on the White Island; where the domes bulged at the base, and went up to a point, like a closed lotus-bud, in which the folded-in leaves had been given a kind of twist, as though two helices, right- and left-handed, had been superimposed so that the lines crossed each other. The lower parts of the huge buildings were immensely solid; then a crown-work of minarets and arches with a very graceful curve, and then the fairylike lotus-bud dome on top.

The building work occupied many hundreds of years, the White Island, when completed, being a marvel of beauty. The Island sloped up to a point, on which were built stupendous Temples, all of white marble inlaid with gold. These covered the whole Island, making it a single sacred City, with a huge central Temple. The dome was over the great Hall, wherein the Four Kumâras appeared on special occasions.

The streets were arranged as four radii, meeting at the central Temple; the view from the end of one of the City streets, say ten miles away, being exceedingly beautiful and impressive. Seen from the north-west the whole looked like the Great Eye of Masonic symbolism, foreshortened so that the curves became cylindrical, the darker lines of the city on the mainland forming

the iris.

Inside and outside the Temples were adorned with many carvings, a large number containing Masonic symbols. There was one series of carvings illustrating the physical and the chemical atoms. Other atoms and particles, such as those of vitality, were modelled in alto-relievo.

For 1,000 years this capital was under construction, for a people destined to become imperial. Gold was much used, especially on white marble. Jewels were also greatly used in decoration, as well as slabs of chalcedony and a stone resembling Mexican onyx. A favourite device was a combination of green jade and the purple porphyry.

Paintings were not used, nor drawings on a flat surface, nor perspective. Friezes were in alto-relievo, exceedingly well done, the figures often being painted.

A massive and splendid bridge connected the White Island with the mainland, the City being known as the City of the Bridge. It was a cantilever construction, very graceful, and decorated with great groups of statuary. The stones of the causeway were 100 feet in length and wide in proportion.

In B.C. 45,000 the City was at its zenith, the capital of an immense Empire which included all East and Central Asia, from Tibet to the coast and from Manchuria to Siam, besides claiming suzerainty over all the islands from Japan to Australia. The ineffaceable stamp of the Âryan blood may still be traced upon races so primitive as the Hairy Ainus of Japan and the Australian aborigines.

The cyclopean buildings were finished with great delicacy and polished to a high degree. Their colossal ruins are said to be the wonder of those who have seen them at Shamballa to-day. The Bridge also still stands, though now only the shifting desert sand flows beneath it.

Such was the mighty City planned by Vaivasvata Manu and built by His children. Many and great were the cities of Asia, but the City of the Bridge outshone them all. And over it ever brooded the mighty Presences who had, and still have, Their earthly dwelling-place on the sacred White Island, giving to this one, out of all the cities of the earth, the ever-abiding benediction of Their immediate proximity.

CHAPTER XLVII

THE FIRST ÂRYAN SUB-RACE: THE HINDU:

B.C 60,000

FROM the small beginning of B.C.60,000 there grew up a thickly populated kingdom, surrounding the Gobi Sea and gradually obtaining dominion over many neighbouring nations, including the Turanians who had so mercilessly massacred its forefathers.

This was the root-stock of the original Root-Race, from which all the branches or sub-races went out as emigrations. The root-stock is usually called the first sub-race; the first sub-race is also sometimes called the Hindu or the Hindu-Âryan sub-race, to describe more particularly the emigrants that went into India. For many huge bands of conquering emigrants marched into India, subdued the land and possessed it. The last remnants of the root-stock left their home and joined their forerunners in India only shortly before the sinking of Poseidonis in B.C. 9,564, being sent away, in fact, to escape the ruin wrought by that tremendous cataclysm.

As we shall see presently, the parent race sent out no less than four migrations westward, the first of these forming the second sub-race, the second the third sub-race, and so on.

From B.C., 60,000 to B.C. 40,000 the parent race grew and flourished exceedingly, reaching its zenith about B.C. 45,000. It conquered China and Japan, peopled chiefly by Mongols, the seventh Atlantean sub-race; going northward and eastward until stopped by the cold. It also added to its empire Formosa and Slam, populated by Turanians and Tlavatlis, fourth and second Atlantean sub-races. It also colonised Sumatra and Java and the adjoining islands, which were then not so broken up as they are now. For the most part they were welcomed in these regions by the people, who looked on the fair-faced strangers as Gods and were more inclined to worship than to fight them.

There is still left in Celebes, an island to the east of Borneo, a hill tribe called Toala, which is a remnant of one of these settlements. They spread also over the Malay peninsula, the Philippines, the Liu-Kiu Islands, the Eastern Archipelago, Papua, the islands on the way to Australia; and Australia itself, then still thickly populated with Lemurians.

Over all the huge Empire, with its many kingdoms, the Manu was suzerain; whether He was in incarnation or not, the Kings ruled in His name, and He sent directions from time to time for carrying on the work.

The general characteristics of the Race, and its civilisation, well repay study. Beginning, as it did, with hundreds of thousands of years of Atlantean civilisation behind it, and having spent thousands of years under its own Manu in Arabia and northern Asia, it was in no sense primitive.

The whole population could read and write; all work was considered honourable, no matter what it was, being done for the Manu. Especially cultivated was the feeling of the brotherhood of

the Race, a wonderful fundamental equality; and a mutual courtesy. Whilst personal merit was fully recognised; there was respect and gratitude for the greater people, and complete absence of rude self-assertion. The people trusted one another, gave each other credit for good intentions, and therefore did not quarrel. Very different was this from the elaborate and luxurious Atlantean civilisation, where each sought his own comfort and recognition for himself, where people distrusted each other and were mutually suspicious. With the Âryans a man's word was sufficient; it would be un-Âryan to break it.

Everyone seemed to know large numbers of other people. in fact the knowledge of a large number of people was one of the qualifications for a man to be an official.

The feeling of brotherhood, however, did not extend outside the Âryan Race itself, as, for example, to the Turanians, who were of different stock, different culture, crafty, cunning, and not to be depended on. Towards these the Âryans showed a marked and dignified reserve, though they were not hostile to foreigners, nor did they despise them. People of other nations were allowed only into the outer courts of houses; for the lodging of strangers, of whom there were few, special houses and courtyards were set apart.

In governing foreign nations, whilst not cruel or oppressive, they were yet stern and somewhat hard.

A man was an Âryan, a "noble man," and this fact imposed on him a certain code of behaviour. The children of the Manu were aristocrats, in the true sense of the word, proud of their high descent, and fully recognising the demands it made upon them. For them *noblesse oblige* was no empty phrase.

The civilisation was bright and happy, with much music, dancing and gaiety, its religion being one of praise and thanksgiving. The people were constantly singing hymns of praise, and recognised Devas behind natural forces. The Dawn-Maidens were joyously hymned each morning, and the Spirit of the Sun was the chief object of worship.

The four Kumâras were regarded as Gods, and Their Presence was evidently felt by a people so near to nature as to be sensitive and psychic. The planet Venus also was an object of worship, perhaps because of the tradition that the Lords of the Flame had descended from Venus. The Sky itself was worshipped, and even the Atom as the origin of all things and a manifestation of the Deity in miniature.

An annual ceremony may serve as an example of one of their greater religious festivals.

There was held every Midsummer Day, in the City of the Bridge, the Festival of the Sacred Fire. Numbers of men, women and children marched in procession at an early hour along the converging streets into the crescent facing the Bridge. Flags were flown from the buildings, the roads were strewn with blossoms, incense was burnt, and the people were clad in coloured silks, often heavily jewelled, wearing splendid coral ornaments and wreaths and garlands of flowers. They marched with clashing

of metal plates and blasts of horns.

In silence they crossed the Bridge and went on into the central Hall. There stood the great throne, cut out of the living rock, gold-encrusted, richly jewelled, covered with golden symbols. Before it stood an altar piled high with fragrant woods. Above it an immense golden Sun, a half sphere, projected from the wall. High in the vault above, the planet Venus hung in the air.

When the people were assembled, the three Manus entered, in their robes of office, the Mahâguru (the future Gautama Buddha) standing behind Vaivasvata; behind him stood Sûrya (the future Lord Maitreya), and nearest to the throne the three Kumaras. In the air above, in a semicircle, were gorgeous purple and silver Devas, attendant, watchful.

Those around the throne softly chanted an invocation to the King to come among them. A single silvery note rang out, the golden Sun blazed, and below it, just over the throne, flashed out a brilliant star. The supreme Lord of the Hierarchy appeared, seated on the throne, and all fell on their faces, hiding their eye from the blinding glory of His Presence.

The King softened the glory so that all might see Him, the Sanat Kumâra, the "Eternal Virgin" in all the beauty of His unchanging Youth, who was yet the Ancient of Days. (It should be noted that the Sanskrit term translated Virgin has a masculine termination.)

He stretched forth His hands towards the altar, and fire blazed upon it. Then He disappeared; the star vanished, the golden Sun glowed but faintly, only the Fire burnt on. The priests then reserved glowing fragments of wood for the altars of the various Temples, these being given to them and to the heads of households, in vessels with lids.

The processions re-formed and passed out to the City with great rejoicings. The sacred fire was placed on the family altars and kept alive during the ensuing year; brands lighted from these altar fires were taken to those who had been unable to attend.

Some of the people studied deeply and reached great proficiency in occult science, in order to devote themselves to certain branches of the public service. They became clairvoyant and gained control of various natural forces, learning to make thought-forms and to leave their physical bodies at will. Remembering the evil in Atlantis, the instructors chose their pupils with great care, one of the lieutenants of the Manu supervising the classes.

Instead of newspapers, clairvoyants obtained any news required, from any part of the Empire, as we do in modern days by wireless or other telegraphy.

Occasionally, if the Manu were unable to impress His instructions on one of His distant rulers, He would bid one of the trained students leave his physical body, travel astrally to the ruler, materialise himself on arrival, and deliver the message. In this way the Manu remained the real Ruler throughout the whole Empire.

Writing was done on various substances, as, for example,

with a sharp instrument on a waxy surface, the script being afterwards filled with a liquid which hardened.

Machinery was simpler than in Atlantis, and there was more handwork. The Manu evidently wished to avoid the extreme luxury of Atlantis.

By B.C. 40,000 the Empire began to decline, the islands and outer provinces asserting a barbarian independence. The Manu still occasionally incarnated, but usually directed from higher planes. The central kingdom, however, remained splendid in civilisation for another 25,000 years and more, whilst the later sub-races were spreading in all directions.

CHAPTER XLVIII

THE SECOND ARYAN SUB-RACE:

THE ARABIAN: B.C. 40,000

THE work of developing the four sub-races, in the four valleys (see p. 285), had now to begin. The Manu selected from the band of Servers, who had been developing in the great Âryan civilisation, a few families which were willing to act as pioneers, to leave the City of the Bridge, and go into the wilderness to found His new colony. Most of those chosen are or have been in the Theosophical Society, and are constantly used in this way as pioneers; such work may be thankless; but it is necessary and to many congenial.

In the third generation Mars and Mercury took birth among the descendants of these, and some of the great people incarnated to specialise the type. When the highly developed egos incarnate, the type is seen at its best, and the race has its Golden Age. Younger egos then come in, but they are, of course, unable to maintain the same high standard.

Those who remained behind in the City of the Bridge thought the people who went to the valley very foolish, for the existing civilisation was a very fine one and there seemed no sense in going off to make a new one in an unreclaimed valley. Moreover the new religion followed by the valley-dwellers seemed quite unnecessary, and inferior to the existing religion.

For some centuries the people in the valley increased and multiplied, the careful specialisation proceeding, until in B.C. 40,000 the Manu decided to send them out into the world (*vide* Diagram XLV, p. 213). Under the leadership of Mars; they retraced the steps of their predecessors to Arabia, with the intention of Âryanising the Arabs who, of all the Atlanteans, were the nearest to the possession of the new characteristics.

Later the Manu in person took the lead of His forces, and obtained permission from a strong and friendly power, then ruling in what is now Persia and Mesopotamia, to march His host along a carefully guarded route.

In this migration about 150,000 men, of fighting age only, were taken; together with some 100,000 women and children.

Two years previously the Manu had prepared the Arabs for His coming by sending messengers. After some little opposition and trouble the Arab Chief allowed the visitors to settle in a great desolate valley on the borders of his territory. In a short time they had the whole valley irrigated, with a stream flowing down the middle of it. Within a year the land was cultivated and good crops obtained. In three years they were prosperous and self-supporting.

The Arab Chief, becoming jealous, endeavoured to induce the Manu to join him in attacking a neighbouring enemy. The Manu

refused; whereupon the Arab joined with his one-time enemy and tried to exterminate the new-comers. The Manu, however, defeated and slew them both, and made Himself Ruler over their combined States. The defeated peoples soon became better off under the Manu, who promptly proceeded to Âryanise them. His kingdom prospered and grew stronger, as He absorbed tribe after tribe, usually without bloodshed and with their own consent.

Before His death; forty years later, He ruled the upper half of Arabia. The southern half held aloof because of a religious fanatic, called Alastor in *The Lives*, who took his stand on the directions of the Manu, given in ancient days, forbidding them to inter-marry with aliens. The southern tribes thus united to oppose their own Leader, now re-incarnated, making His own original order as to purity of race their rallying cry against Him.

The Manu had intended to Âryanise these descendants of His old followers, but the idea that they were a chosen people was held by them so strongly that they rejected his overtures. It will be recollected that it was from these people that the Jews were descended, as we shall see presently in more detail.

While this long struggle was going on the Mahâguru (the future Gautama Buddha) came to the second sub-race to give it the new religion which He had been teaching in Egypt, as a reform of the ancient faith there prevailing.

At this time, about B.C. 40,000 an Atlantean Empire was ruling in Egypt; it had attained a very high state of civilisation; it had immense Temples, a very ornate ritual, and elaborate religious teaching. The Egyptians were profoundly religious, as well as psychic. They held gorgeous religious processions, and ceremonies palpitating with reality, whole multitudes being carried away with passionate emotion as they mourned the death of Osiris and called on him to return.

The Mahâguru came to this people as Tehuti or Thoth, called later by the Greeks Hermes. His doctrine was that of the Inner Light. "The Light that lighteth every man that cometh into the world" was a phrase of His echoed in the fourth Gospel. "I am that Light," He bade them repeat, "that Light am I." "That Light is the true man. . . . The Light is hidden everywhere; it is in every rock and in every stone. . . . The Light is the life of men. To every man - though there are glorious ceremonies, though there are many duties for the priest to do, and many ways in which he should help men - that Light is nearer than aught else, within his very heart. For every man Reality is nearer than any ceremony, for he has only to turn inwards, and then will he see the Light. That is the object of every ceremony, and ceremonies should not be done away with, for I come not to destroy but to fulfil. When a man knows, he goes beyond the ceremony, he goes to Osiris, he goes to the Light; the Light Amun-Ra, from which all came forth, to which all shall return."

And again : "Osiris is in the heavens, but Osiris is also in the very heart of men. When Osiris in the heart knows Osiris in the heavens, then man becomes God; and Osiris, once rent into

fragments, again becomes one."

To Pharaoh, the Monarch, He gave the motto: "Look for the Light," for only as a King sees the Light in the heart of each can he rule well. To the people He gave the motto: "Thou art the Light. Let that Light shine." This motto was inscribed on a Temple pylon, doors of houses, and on models of the pylon made of precious metals or of clay. Another favourite motto was: "Follow the Light," and this became later: "Follow the King," spreading west-ward and becoming the motto of the Round Table. The people said of their dead: "He has gone to the Light."

From Egypt, as said; the Mahâguru went to Arabia to teach His doctrine to the second sub-race. Returning to the history of the second sub-race, after some centuries a more ambitious ruler succeeded to the throne, marched down to the ocean; and proclaimed himself Emperor of Arabia.

A fanatical section of the southerners; however, under a prophet of rude and fiery eloquence; protested against what they considered the triumph of evil, abandoned their conquered fatherland and settled on the opposite Somali coast. There they lived and increased in numbers for some centuries until a serious rupture occurred. The ruling prophet, enamoured of a young negress, boldly pronounced that this was no infringement of the stern order against inter-marriage with other races; the negroes being merely slaves, and therefore goods and chattels rather than wives.

A substantial minority rebelled against this clumsy artifice of a licentious priest, made themselves into a caravan and wandered round the Gulf of Aden, up the Red Sea coast, into Egyptian territory. Their story pleased the Pharaoh, who gave them an outlying district in which to settle.

A later Pharaoh demanded additional taxation and forced work. Resenting this, they again emigrated, this time to Palestine, where we know them as the Jews, still maintaining the theory that they are a chosen people.

The karma of the rejection has left the Jews ever since a race apart, the same egos incarnating again and again in that line instead of passing from race to race in the usual way. It is possible that some unconscious perception of this difference may account for the treatment the Jews have received from other races; it may also be partially due to the fact that because of the tradition of that original selection by the Manu they have always had a feeling somewhat similar to that of the Brâhmanas - that they are superior to the rest of the world.

Originally a nomad tribe like the Bedouin Arabs, they lived largely by robbery, their deity being confessedly but a tribal god who fought against the gods of other nations and was perpetually vaunting himself as superior to them. His demand for blood-sacrifices is a criterion as to his status.

The carrying away into captivity to Babylon of a number of these turbulent people was the best thing that could have happened to them, for then for the first time they came into contact with a highly civilised race, and heard of a supreme God.

They tried to identify their own tribal deity with this Supreme Being; and so caused much confusion. When they returned from captivity, they re-wrote their scriptures and put into them a certain admixture of the higher ideas about a supreme deity.

The Founder of Christianity having taken possession of a Jewish body, and all the earlier teachers of the religion also being Jews, there was brought into Christianity a very mixed conception of a god full of irreconcilable characteristics. If the Christians could have left alone the primitive Jewish conceptions, and taken the teachings of the Christ, who spoke of the Deity as the Father in Heaven, many of the troubles of the Christian Church would have been avoided.

The majority, left behind in Somali-land, harassed by slave-raiders, after losing thousands of lives, abandoned their homes, and migrated across the Gulf back to Arabia. They were received in a friendly manner and were soon absorbed in the general population. They called themselves the "true Arabs," though they deserved the title less than any. Even to-day there is a tradition that the true Arabs landed at Aden and spread northwards. And among the Hamyaritic Arabs of southern Arabia may still be seen traces of the admixture of negroid blood so many thousands of years ago. There is also a legend that the Mostareb Arabs of northern Arabia went away for a long time into Asia, far beyond Persia, and returned bringing with them many marks of their stay in foreign lands.

The second sub-race grew and increased for many thousands of years, extending its dominion over nearly all Africa, except that part possessed by Egypt. Later, they invaded Egypt, and for a short time ruled as the Hyksos Kings; but their palmy days were when they ruled the great Algerian island, pushed down the east coast to the Cape of Good Hope, and founded a kingdom which included Matabeleland, the Transvaal and the Lorenzo Marques district.

The Servers, after several births in Arabia, took part in the building of the South African Empire, Mars being there as Monarch. Cities were built of the favourite massive type, and huge Temples, the civilisation being by no means unworthy. But the gulf between the native Africans and the Arab conquerors was too wide to be spanned, and the Africans remained labourers and domestic servants, kept entirely in subjection.

The Arabs made settlements also on the West Coast of Africa; but they came in collision with men from Poseidonis, and were eventually entirely driven back.

Madagascar was invaded, the southern Empire trying to occupy it, but it succeeded only in maintaining for a time settlements on parts of the coast.

When the great Sumero-Akkad Empire of Persia; Mesopotamia and Turkestan finally broke up into small States and disorder, an Arab monarch fought it for twenty years and made himself master of the plains of Mesopotamia and of almost the whole of Persia, up to the lake of Khorasân; where the desert now is. But he failed to conquer Kurdistân and the mountain tribes.

On his death; his son consolidated rather than tried to extend his Empire. It held together for some centuries, but dynastic troubles broke out in Arabia itself; and the governor of Persia, a cousin of the Arab King, proclaimed himself independent. The Arab dynasty which he founded lasted for 200 years, but amidst incessant warfare.

Then again came a period of upheaval and of small tribes, and frequent raids from the savage Central Asian nomads. One Arab King, tempted by the fabulous wealth of India, sent a fleet to attack it, but his fleet was destroyed and his men killed or taken prisoners.

After the final collapse of the Arabian Empire of Persia and Chaldæa, there were centuries of anarchy and bloodshed, the countries becoming depopulated. So the Manu determined to come to their rescue; and sent to them His third sub-race, which established the great Persian Empire of the Îrânians.

The Arabian sub-race is sometimes called the Semitic, a name which belonged originally to the fifth sub-race of the Atlanteans.

CHAPTER XLIX

THE THIRD ÂRYAN SUB-RACE: THE ÎRANIAN: B.C. 30,000

AN interval of 10,000 years elapsed after the despatch of the second sub-race before the Manu sent forth the third. This brings us to B.C. 30,000. The City of the Bridge at that time was still great, though decreasing in splendour.

The people for the third sub-race had been prepared for many centuries, being kept apart in one of the four valleys until they showed quite a distinct type. In His original selection in Atlantis, the Manu had included a small proportion of the best of the sixth Atlantean sub-race, the Akkadians, and He now utilised the families which had preserved most of that Akkadian blood, sending into incarnation in them His group of pioneers. One or two of them were sent further afield to bring back a strain of Akkadian blood from its home in more western countries.

The people of the young third sub-race, as they multiplied, were more pastoral than agricultural, keeping large herds of sheep, cattle and horses. The Manu who, on this occasion; had considerably modified His appearance, came into the sub-race in its fifth generation, and allowed the people to multiply for some 2,000 years until there was available an army of 300,000 fighting men. He then sent into incarnation Mars, Corona and others, fit captains for His host, and Himself led forth the army, leaving

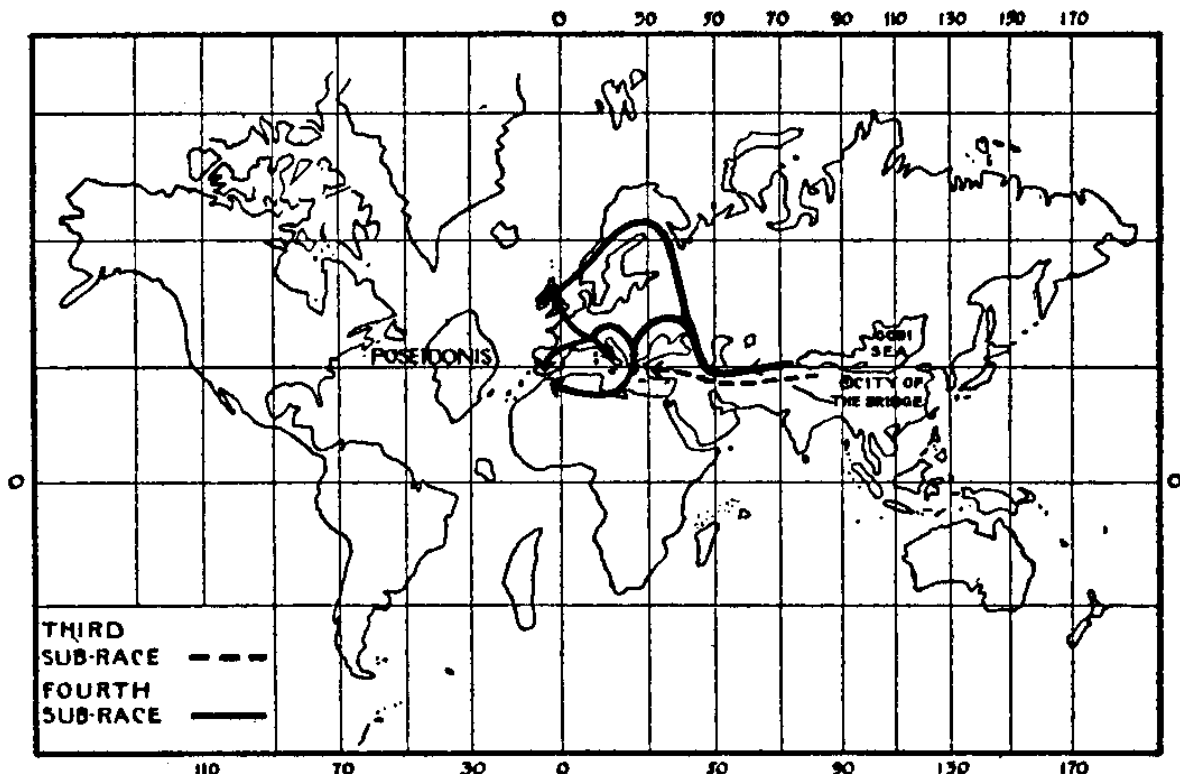

DIAGRAM XLVI.—The Third and Fourth Sub-Races.

the women and children behind in the valley.

The route (*vide* Diagram XLVI) lay through difficult country, some of the passes of the Tian-shan range, where it curves round into the Kashgar district, being 9,000 feet high. For part of the way they followed the course of a river which passed through ravines and valleys. Pouring his fine army into Kashgar, the Manu easily defeated such nomad hordes as ventured to attack Him as He crossed their deserts. The weapons used were long and short lances and spears, short strong swords, slings and bows. Many of the villages, long harassed by forays, often pillaged and massacred; welcomed a power which would restore and maintain order.

In two years Persia was overrun without much difficulty; and then Mesopotamia was subdued. Military posts were established at frequent intervals; the country being divided between His chiefs. Forts were built, first of earth, later of stones, until a network was made over Persia to prevent raids from the mountains. No attempt was made to conquer the warlike tribes, but they were practically confined within their fastnesses, and were no longer permitted to plunder the peaceable inhabitants of the plains.

The land was conquered down to the desert to the south and up to the Kurdish mountains on the north. When the country had been settled and peaceful for some years the Manu called to it the vast caravan of the wives and children; left behind in the valley.

For the next fifty years the Manu kept the new Empire under His direct rule, visiting it several times, and appointing members of His family as its Governors. He was succeeded by Mars, Corona being the independent King of Persia.

From this time the third sub-race rapidly increased in power until in a few centuries it dominated the whole of western Asia from the Mediterranean to the Pamirs, and from the Persian Gulf to the Sea of Aral.

The third sub-race; when it settled down in Persia and Mesopotamia, numbered about a million, and they multiplied rapidly, incorporating in their nation also the sparse population which existed in the country when they entered it.

With certain changes its Empire lasted until about B.C. 2,200, though in this 28,000 years there were naturally many fluctuations.

Most of the time Persia and Mesopotamia were under separate rulers, of whom sometimes the one; sometimes the other, was nominally Overlord. Sometimes the two countries split up into smaller States, owing a kind of loose feudal allegiance to the central King. All through their history they had constantly recurring difficulties with the nomad Mongolians on the one hand and the mountaineers of Kurdistân and the Hindû Kush on the other. Sometimes the Îrânians pushed the savages back, at other times they withdrew from them.

At one period they ruled most of Asia Minor and made temporary settlements in several of the countries bordering the mediterranean. At one time they held Cyprus, Rhodes and Crete;

but on the whole in that part of the world the Atlantean power was too strong for them and they avoided conflict with it.

On the west at various times they came into conflict with powerful Scythian and Hittite confederations. Once at least they conquered Syria, but abandoned it as useless. Twice they embroiled themselves with Egypt, but could do little against it.

During most of this long period they kept up a high level of civilisation, and many relics of their great architecture lie buried beneath desert sands. Various dynasties arose among them; and several different languages prevailed in their chequered history.

They avoided hostilities with India, being separated from it by a wild territory, a sort of no-man's land. Arabia troubled them but little, for there again a useful belt of desert intervened.

They were great traders; merchants, manufacturers, being much more settled than the second sub-race, and with more definite religious ideas. The best specimens of the Parsis of the present day give a fair idea of their appearance. The present inhabitants of Persia have still much of their blood in them, though largely commingled with that of their Arab conquerors. The Kurds; the Afghâns and the Baluchis are also mainly descended from them, though with various admixtures.

In B.C. 29,700 the Mahâguru (the future Gautama Buddha) came to the third sub-race as the first Zarathustra and founded the Religion of the Fire. The second son of Mars; the tenth of the Kings who had succeeded Corona, was chosen as the vehicle for the Supreme Teacher, the Bodhisattva. Sûrya (the future Lord Maitreya) was the Chief Priest at the time, at the head of the State religion, which was a mixture of Nature and Star worship, and he wielded an immense authority, partly because of his office and partly because he was of the blood royal. Mercury had been trained from childhood for his great destiny.

The Mahâguru came from Shamballa in his subtle body and took possession of the body of Mercury. A great procession started from the Royal Palace to the chief Temple of the city; the King walked on the right, under a golden canopy, the High Priest under a jewelled canopy on the left; between them, carried shoulder-high, seated on a golden chair, was the Prince. Halting at the foot of the steps in front of the door of the Temple; the three central figures ascended the steps, the Prince, who was now the Mahâguru, in the centre.

Sûrya announced that He who stood there was no longer the Prince, but the Messenger from the Most High and from the Sons of the Fire who dwelt in the far East, whence their forefathers had come forth. As the Head of their faith, he humbly bade Him welcome.

The Mahâguru then spoke of His mission, entrusted, to Him by the Lords of the Fire, and told them He had brought them a symbol which should ever keep Them in their minds. He told them that Fire was the purest of all elements and the purifier of all things, and that thereafter it should be for them the symbol of

the Holiest. It was embodied in the Sun and burned, though hidden, in the heart of man. It was heat, light, health and strength, and in it and by it all things had life and motion. He told them how in all things they should see the hidden presence of the Fire.

Lifting His right hand, there shone in it a Rod shooting out flashes on every side; He pointed the Rod to the East, cried some words in an unknown tongue, and the heavens became a sheet of flame. Fire fell upon the altar, on which wood, gums and incense had been piled, and a Star shone above His head. Priests and people fell on their faces, Sûrya and the King bowed in homage.

The procession then returned to the Palace. The people carried home the flowers which had rained down from the sky when the Fire had passed, and kept them as heirlooms for their descendants.

The Mahâguru remained for a considerable time in the city, going daily to the Temple to instruct the priests. He taught them that Fire and water were the purifiers of all else and must never be polluted, and that even the water was purified by the Fire: that Fire and water were the two Spirits, Fire being life and water form: and much else.

It is possible that out of this arose the later teaching of Ormuzd and Ahriman. There are passages which show that the double of Ormuzd was not originally an evil power, but rather matter, while Ormuzd was Spirit.

Around the Mahâguru was an august assembly of Masters and others less advanced. These He left to carry on His teaching when He departed.

His departure was as dramatic as His first preaching. Speaking from the great platform for the last time, though the people did not know it was to be the last time, He inculcated the duty of gaining knowledge and of practising love, and bade the people follow and obey Sûrya, whom He left in His place as Teacher. Then He told them He was going, blessed them and, lifting up His arms to the Eastern sky, He called aloud; out of the sky came a whirling cloud of flame, which enwrapped Him as He stood, and then, whirling still, it shot upwards and eastwards, and He was gone.

Mercury, who, in his subtle body, had ever remained near Him, at His service, returned with Him to the Holy Ones, and rested for a while in peace.

After He had gone Star-worship did not at once disappear, for the people regarded His teaching as a reform, not as a substitution, and still worshipped the Moon, and Venus, the constellations and the planets. But the Fire was held sacred as the emblem of the Sun, the new religion enfolding rather than replacing the old one. Gradually the Faith of the Fire grew stronger; Star-worship retreated from Persia to Mesopotamia, where it remained the dominant faith, and took a very scientific form.

Astrology there reached its zenith, and scientifically guided human affairs, both public and private. Its priests

possessed much occult knowledge, and the wisdom of the Magi became famed throughout the East.

In Persia the Religion of the Fire triumphed, and later Prophets carried on the work of the great Zarathustra, and built up the Zoroastrian Faith and its literature, which have endured to the present day.

CHAPTER L

THE FOURTH ARYAN SUB-RACE: THE KELTIC: B.C. 20,000

BY this time the great Central Asian Race was far on the road to its decline, but the Manu had been careful to preserve dignity, power and vigour in the seed of the fourth and fifth sub-races, to which He had given much special training. He had drawn apart, into one of the four valleys, some of the most refined families from the City, and there arose in the colony a division of classes. For the Manu was now striving to develop certain new characteristics, to awaken imagination and artistic sensibility, to encourage poetry, oratory, painting and music, and the people who responded to this could not do agricultural or other hard manual labour.

Anyone who showed artistic talent was accordingly drafted off for special culture. He trained them also to be enthusiastic, and to be devoted to their leaders. So effective was the work, carried on for many centuries; that the special marks of the Kelt remain to this day.

The valley was managed practically as a separate State, art of all kinds being endowed in various ways. As time went on the sub-race grew somewhat conceited; looking upon the rest of the kingdom as what we should now call "Philistine." Their vanity was justified, for they were extraordinarily handsome, cultured and refined in their tastes, and with much artistic talent.

The Servers took no part in the founding of the fourth and fifth sub-races. They were at work in many countries, and may be met in the *Lives of Alcyone*.

Ten thousand years after the third sub-race had gone forth, *i.e.*, in B.C. 20,000, the fourth sub-race was instructed to proceed along the northern frontier of the Persian Kingdom (*vide* Diagram XLVI), and to win for themselves a home in what are now the Caucasus mountains, which were then occupied by wild and predatory tribes.

The Manu arranged with the Persian Monarch to allow free passage and food for the enormous host, and also to send with them a strong army to assist in subduing the mountaineers. Even so it proved no easy task, for though the tribes could easily be defeated in a pitched battle, yet in guerilla warfare they were far more formidable antagonists.

Eventually they established themselves in the district of Erivan, on the shores of Lake Sevanga. Increasing greatly in number, they exterminated the tribes or reduced them to submission, until eventually all Georgia and Mingrelia was in their hands. In 2,000 years they occupied Armenia and Kurdistan as well, and later on Phrygia; so that they held nearly all Asia Minor as well as the Caucasus. In their mountain home they flourished and became a mighty nation.

Their country was so broken up that free communication was

impossible; they therefore formed rather a federation of tribes than an Empire. Even after they had begun to colonise the Mediterranean coast; they looked back to the Caucasus as their home, and it was really a second centre from which the sub-race went forth to its great destiny.

By 10,000 B.C. they resumed their westward march, travelling as tribes; so that they finally arrived in Europe, their ultimate destination; in comparatively small waves.

The tribes left many of their members behind to carry on their work of cultivation. These intermarried with other races, and their descendants, with some admixture of Semitic blood, are the Georgians of today. But in some cases the whole tribe emigrated to the new home.

The first section to cross into Europe from Asia Minor were the ancient Greeks - not the Greeks of our "Ancient History," but their ancestors, sometimes called Pelasgians. Plato in *Timæus* and *Critæus* mentions that the Egyptian priests spoke to a later Greek of the splendid race which had preceded his own people in his land. How they had turned back an invasion from the mighty nation from the West that had subdued all before it until it shivered itself against these Greeks. In comparison with these the Greeks of our history were as pigmies. From these sprang the Trojans who fought the modern Greeks; and the city of Agadé in Asia Minor was peopled by their descendants.

For a long time they held the seaboard of Asia Minor and the islands of Cyprus and Crete, all the trade of that part of the world being carried in their vessels. A fine civilisation was built up in Crete, enduring for thousands of years, and still flourishing in B.C. 2,800. Minos was its chief founder, and he was one of these elder Greeks, even before B.C. 10,000.

The final cause of their definite entry into Europe was an aggressive movement on the part of the Emperor of Poseidonis. For many centuries the coasts and islands of the Mediterranean had been in the hands of a number of small nations, most of them Etrurian or Akkadian; but some Semitic, who were usually peaceful merchantmen. The Emperor of Poseidonis, deciding to annex them, attacked with a great army and fleet. He subdued the large Algerian island, ravaged the coasts of Spain, Portugal and Italy, and forced the peoples to submit to him. Egypt was contemplating submission, having no great navy with which to oppose him.

The Greek sailors of the Levant; however, defied him; although he had only half his fleet at hand, he attacked them, and lost his ships, much in the way the Spanish Armada was lost when attacking the English. The Greek vessels were smaller, faster, of less draught, and easier to handle than the clumsy Atlantean ships. The Greeks were helped also by the weather, so that the defeat was overwhelming.

The Atlanteans then attacked with the other half of their fleet, and were again defeated, though this time with heavy loss to the Greeks. The Atlantean Monarch escaped, and landed in Sicily, where some of his troops were established. The news of the destruction of the fleet encouraged the conquered populations

to rise against him, and he had to fight his way home through the whole length of Italy. Withdrawing his garrisons as he went, he reached the Riviera with a few exhausted followers. Fleeing across France in disguise, he eventually reached his own kingdom in a merchant ship.

Although he vowed vengeance against the Greeks, the discontented tribes in his own island rebelled, and he was never again able to undertake foreign aggression.

The success of the Greeks immensely strengthened their position in the Mediterranean, and within the next century they had established settlements on many of its shores.

In B.C. 9,564 the terrible tidal wave; created by the sinking of Poseidonis; destroyed most of the Greek settlements, and seriously injured the remainder. Both the Gobi Sea and the Sahara desert became dry land; and the most appalling convulsions took place.

Urgent messages for help were sent to the highland home in the Caucasus, which had been but slightly affected. Eventually relief was organised on a large scale. The Greek settlements had been all on the sea-coast, and the populations of the interior, though overawed by the Greeks, had not always been friendly. When most of the Greeks had been destroyed by the cataclysm, the few survivors were often persecuted, and even enslaved, by the interior races.

When the bottom of the Sahara was heaved up, its waters poured out through the gap between Egypt and Tunis, where Tripoli now stands; the interior suffered little; but the sea-coasts, on which the Greeks had settled, were destroyed. The Sahara gradually sank down again. and a new coast line rose; assuming the configuration known to us along the African coast, the great Algerian island joining the mainland; and forming with the new land the northern coast of Africa.

Almost all shipping had been destroyed, yet so great was the energy of the Greeks that within a few years all the ports of Asia Minor were in working order and fleets of new ships went out to re-establish the colonies and to deliver Greeks from foreign yoke. The Greeks annexed all the best harbours of the new coast line, and since most of the trade of Egypt was also in their hands, the Mediterranean remained for centuries practically a Greek sea. They even carried their trade eastward, an expedition going to Java, where they founded a colony, with which a connection was long kept up.

Later the Phœnicians and Carthaginians divided the trade of the Mediterranean with the Greeks. The Phœnicians were a fourth Race people derived from the Semites and Akkadians (fifth and sixth Atlantean sub-races); the Carthaginians were also Akkadian, intermixed with Arab, and with a dash of negro blood.

The emigration of the fourth sub-race into Europe was almost continuous, so that it is not easy to divide it into distinct waves. If we count the Greeks as the first wave, the Albanians may be considered the second; and the Italian race the third, both these going to the countries where they now are.

After an interval came a fourth wave of astonishing vitality, that to which modern ethnologists restrict the name "Keltic." This became the predominant race over the north of Italy, the whole of France and Belgium and the British Isles, the western part of Switzerland, and Germany west of the Rhine.

The Greeks of our "Ancient History" were a mixture, derived from the first wave, mingled with settlers from the second, third and fourth, and with an infusion of the fifth sub-race, coming down from the north and settling in Greece. These gave the rare and much-admired golden hair and blue eyes, occasionally found among the Greeks.

The fifth wave practically lost itself in the north of Africa and only traces of it can now be found, much mixed with the Semitic (fifth Atlantean sub-race) and the Arabian, among the Berbers, the Moors, the Kabyles, and even the Guanches of the Canary Islands, in this last case mingled with the Tlavatlis.

The fifth wave mingled with the fourth in the Spanish peninsula, and at a later stage, only some 2,000 years ago, it contributed the last of the many elements which go to make up the Irish; for to it belonged the Milesian invaders who poured into Ireland from Spain (some of them founding a dynasty of Milesian Kings in France), and bound it under curious forms of magic, as will be explained presently.

But a much finer element had previously come into Ireland from the sixth wave, which left Asia Minor, pushing north-west until it reached Scandinavia, where it intermingled to some extent with the fifth sub-race, the Teutonic. They came to Ireland from the north, and are known in history as the Tuatha-de-Danaan, spoken of more as Gods than men.

The Tuatha-de-Danaan were handsome, with oval faces, clear complexion, mostly dark hair; and deep blue or almost violet eyes. Sometimes the hair was lighter and the eyes grey, but the other type was most usual, and may be seen exactly reproduced among the Irish peasants to-day.

The Tuatha-de-Danaan were also intellectually and spiritually much in advance of the mixed race they found in Ireland, and the period of their rule was a sort of golden age, as tradition correctly bears witness. Ireland was unquestionably the seat of a high civilisation and a centre of philosophy, whilst England was covered by dense forests and in a state of relative savagery.

The Milesians from Spain, who overcame the Tuatha-de-Danaan, were a far inferior race, though they had the rude physical strength of youth and much knowledge of the lower magic. They were bullet-headed, rugged, and often positively ugly, with light or vividly red hair; the type may still be seen among the peasants in South Ireland almost in its original purity.

There is a radical difference of type between the stolid matter-of-fact Anglo-Saxon and the imaginative and poetical Irishman. The average English peasant lives almost entirely on the physical plane. The average Irish peasant of the south and west lives much on the astral plane. His thoughts are usually far

away, occupied with legends of the past, or with stories of saints, angels and fairies.

Quite apart from vexed questions of politics, there is another cause of the poverty and general tuck of prosperity of the Irish. The Milesians cast a spell upon the race, subjecting it to the glamour of a great illusion. Their priests covered the country with a network of strongly magnetised centres, which even now radiate a strong influence. Crowds of nature-spirits of a certain type are still irresistibly attracted to these centres, are permeated by their influence, and unconsciously become its ministers, spreading it over the country wherever they go. The spell was two-fold - the curses of disunion and lethargy - that they should never be able effectively to combine together, but always quarrel among themselves; and that they should apathetically submit to the domination of whoever wielded or inherited the magnetic power. Consciously or unconsciously, the Roman Catholic Church has come into this heritage, and profits by what still remains of that ancient spell, so that her rule is unquestioned through all the districts concerned.

On the whole the fourth sub-race had brown or black hair and eyes, and round heads, and were usually not tall in stature. Their character showed clearly the result of the Manu's efforts thousands of years before, for they were imaginative, eloquent, poetical, musical, capable of enthusiastic devotion to a leader, and splendidly brave, though liable to quick depression in case of failure. They seemed to tuck what we call business qualities; and they had scant regard for truth.

After the catastrophe of B.C. 9,564, some of the old Greeks settled in Hellas and occupied the country. The first city on the site of modern Athens was built B.C. 8,000. (The Athens of our history was begun about B.C. 1,000, the Parthenon being built in B.C. 480.)

Here the Mahâguru came to them as Orpheus the Founder of the Orphic Mysteries, from which the later Mysteries of Greece were derived. He came about B.C. 7,000, living chiefly in the forests, where He gathered His disciples round Him. He came as a Singer, loving the life of Nature, averse to cities and to the crowded haunts of men.

He taught by song, by music of voice and instrument, carrying a five-stringed instrument, probably the origin of Apollo's lyre, and using a pentatonic scale. By sound He worked upon the astral and mental bodies of His disciples, purifying and expanding them; by sound He drew the subtle bodies away from the physical, and set them free in the higher worlds.

His music was quite different from the sequences, repeated over and over again, by which the same result was brought about in the Root-stock of the Race, and which it carried with it into India. Orpheus worked by melody, using the melody of each etheric centre or chakram to stir it into activity.

He showed His disciples living pictures, created by music; and in the Greek Mysteries this was wrought in the same way, the tradition coming down from Him. He taught that sound was in all

things; and that if man would harmonise himself, then would the Divine Harmony manifest through him and make all Nature glad.

Traditions of Him spread far and wide. He became the God of the Sun, Phæbus-Apollo, and, in the North, Balder the Beautiful.

The Mahâguru thus appeared to the sub-races successively as Vyâsa, Hermes, Zarathustra and Orpheus, teaching the doctrine of Sun, Light, Fire and Sound respectively; all these giving the single message of the One Life, the One Love.

From Hellas some of the disciples went to Egypt and fraternised with the teachers of the Inner Light, and some went as far as Java.

Nearly 7,000 years later the Mahâguru came to His ancient people for the last time, reached final Illumination, and became a Buddha.

CHAPTER LI

THE FIFTH ARYAN SUB-RACE: THE TEUTONIC: B.C. 20,000

TURNING back to B.C. 20,000, we find the fifth sub-race being prepared simultaneously with the fourth, though in a different way. It was set apart in a valley far from the City of the Bridge, on the north of the Gobi Sea. Into it the Manu introduced a few of the best specimens of the third sub-race, now thoroughly specialised in Persia, and also a few Semites from Arabia.

He chose especially men who were tall and fair, and when He Himself was born in it His body showed those characteristics prominently. It will be recollected that the Manu starts each sub-race just as He does the Root-Race, by incarnating in it Himself; and the form He chooses to take largely determines the appearance of the sub-race.

The fifth sub-race was strong and vigorous, much larger than the fourth, and was tall, fair, long-headed, with light hair and blue eyes. The character also was very different from that of the Kelts; it was dogged and persevering, with little of the dash of the fourth. Its virtues were not of the artistic type, but rather of the business and commonsense sort, blunt and truthful, plain-spoken and straightforward, caring for the concrete rather than for the poetic.

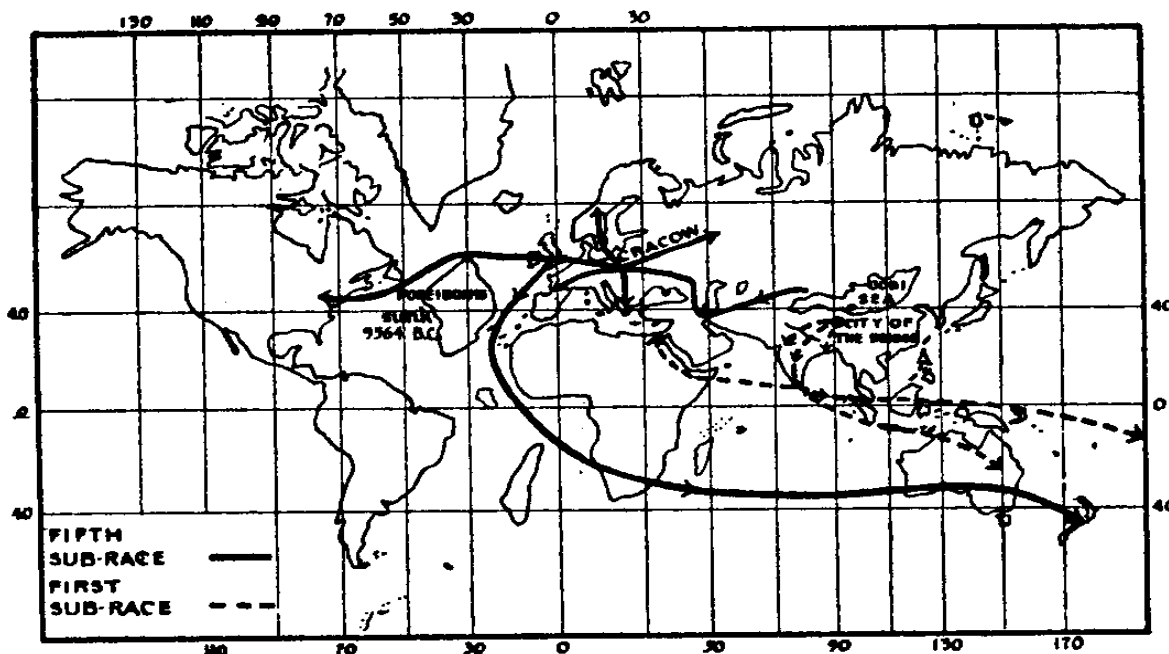

DIAGRAM XLVII.—The Fifth and First Sub-Races.

The fourth and the fifth sub-races left their respective valleys together in B.C. 20,000, and passed together through

Persia (*vide* Diagram XLVII), though their eventual destinies were very different.

The fifth sub-race, small in number, moved along the shores of the Caspian Sea, and settled in Daghestân. There it grew slowly for thousands of years, extending along the northern slopes of the Caucasian Range, and occupying the Terek and Kuban districts. It differentiated into several distinct types; and began its great march to world dominion nearly 1,000 years after the cataclysm of B.C. 9,564.

The swamps of Central Europe having now become habitable, the emigrants moved north-west to what is now Cracow in Poland. There they remained for some centuries, disease thinning their ranks, for the marshes were not quite dry enough for safe habitation. It was chiefly from Cracow that the final radiations took place. The first was the Slavonic; one party went east and north; and from it came largely the modern Russians; the other went more south, and is now represented by the Croatians, Servians and Bosnians.

The second wave was the Lettish, though it did not go far. It gave us the Letts, the Lithuanians and the Prussians.

The third was the Germanic, those called especially the Teutons spreading over Southern Germany, others going north and becoming the Goths and Scandinavians.

In modern history we find the descent of the Scandinavians upon Normandy; of the Goths upon Southern Europe, and the spreading of the fifth sub-race over Australia, North America and South Africa; and its dominance in India, where the Root-Stock of its people is settled.

The fifth sub-race has still to build, like its predecessors, its World-Empire, though this has already begun. The blunder of the eighteenth century, which tore away the North American Colonies from Great Britain, may be remedied by a reunion; in some form or other, of the severed halves. It seems possible; also, that a similar alliance with Germany, the remaining great section of the Teutonic sub-race; would weld the whole sufficiently into one to make a federated Empire. For part of the "Plan" very shortly to be realised is the drawing together of the various branches of the Teutonic sub-race. Late events show the rising of India into her proper place in this extending Empire, destined to be mighty in the East as well as in the West.

As this World-Empire rises to its zenith during the coming centuries, the group composed of men of great genius, mentioned under (4) on p. 123, will be sent to take incarnation in it, to lift it to the highest pinnacle of literary and scientific glory, till it overtops the vanished Empires of the Arabians, the Persians, the Romans, of the second, third and fourth sub-races of 11 the Aryan stock, and rises to a height even loftier than that attained by Atlantis in its palmyest days.

At the present time a magnificent opportunity is being offered to the Anglo-Saxon race; to the whole Teutonic sub-race, if only it will sink its rivalries and jealousies and take it. If it should unfortunately fall, there is another nation already

chosen to assume the sceptre which in that case would fall from its hands. Such failure would cause a slight delay, while the new nation was being pushed rapidly forward to the necessary level, but at the end of a few centuries exactly the same result would have been achieved. The intended end will be achieved; through whose agency this will be done matters very much to the agents, but nothing at all to the total progress of the world.

As was mentioned when speaking of the Atlantean Race, the sacred word of the fifth or Aryan Root-Race is Om, that of the Atlantean Race being Tau. The words of the Root-Races taken in succession are said to be syllables of one word, which is the true sacred Name.

Each Root-Race has its own special quality to unfold. That of the fifth Root-Race is manas or mind—that type of intellect that discriminates, that notes the differences between things. When perfectly developed, differences are noted calmly, solely for the purpose of understanding them and judging which is best. In the stage of half-development at which we are now, most people look for differences not so much in order to understand as to oppose, often even to persecute those who hold opinions different from their own. This elementary stage will, of course, in due time be outgrown. The Âryan Race is less dominated by the passions of the senses, is more open to the influence of manas, and is thus obtaining a firmer grasp of knowledge, a wider range of intellect. This fifth Root-Race is thus developing that aspect of the Divine nature known by the Hindus as Chit, or Intelligence.

CHAPTER LII

THE FIFTH ROOT-RACE STOCK AND ITS DESCENT INTO INDIA: B.C. 18,800

FROM B.C. 40,000 to B.C. 20,000 the great Empire had been declining. During this period the Manu and His immediate group had worked chiefly with the sub-races, in which they had incarnated. The Kingdom centring round the City of the Bridge was now but a small one; the Mongolian and Turanian races had asserted their independence. The people built no more; but lived in the ruins of the work of their forefathers. The more evolved egos were incarnating in the sub-races, so that in the Mother State the level of learning steadily sank. Trade had fallen almost to zero, and the people were becoming agricultural and pastoral only.

In B.C. 18,800, the sub-races being established, the Manu wished to get the Root-Stock into India, the land chosen for its further evolution. The civilisation in India was Atlantean, but now over-luxurious and effete, the Toltec higher classes being indolent and self-seeking. Much, however, remained of a noble literature, and there was a great tradition of occult knowledge; both of which had to be preserved for the future. The wealth of the country was lavishly displayed, and the warrior spirit had died out.

The entire removal of the Race from Central Asia was necessary for three reasons: (1) so that Shamballa should be left in solitude; (2) so that India should be Âryanised; (3) so that the Race should not be involved in the coming cataclysm which would greatly alter Central Asia.

A schism had occurred in the Root-Stock, owing to some of them intermarrying with Tartars; these seceders had been pushed back into the northern hills, where Mars was their King. Being told in a dream certain of the plans of the Manu, Mars, in B.C. 18,875, led his people out into India (*vide* Diagram XLVII, p.238), having to do a little fighting on the way, for, though he never attacked, he was often assailed. For a time he enjoyed the hospitality of Virâj, then ruling as King Podishpar over the greater part of northern India, the alliance being cemented by the marriage of the daughter of Mars to the son of Podishpar.

Southern India was then a large Kingdom under Saturn, ruling as King Huyaranda or Lahira. Sûrya was the High Priest under the name Byarsha; he knew beforehand of the coming of these people, and they were accordingly made welcome by the King, who settled them in his land. Sûrya declared also that "the high-nosed strangers from the north" were fitted to be priests and should hold office hereditarily. Those who agreed became priests, and were the ancestors of the Brâhmanas of Southern India, living as a separate class.

Others intermarried with the Toltec aristocracy, gradually Âryanising the whole upper classes of the country, so that the

south of India passed peacefully under Âryan rule, the second son of Mars being elected later to the throne, when it became vacant.

From this migration onwards all the immigrants into India are spoken of as the first sub-race; since the whole Root-Race, the ancient stock, passed over into India.

About B.C. 13,500 a mission went from the South Indian Kingdom to Egypt, the order coming from the Head of the Hierarchy through the Manu. The expedition, under the leadership of Mars, travelled through Ceylon, by water up the Red Sea, then only an inlet; into Egypt, which was then highly civilised. Sûrya was a High Priest in Egypt, and he advised the Pharaoh to welcome the immigrants. Later he counselled the Pharaoh to marry his daughter to Mars, and to name Mars his successor. This was done; so that on the death of the Pharaoh an Âryan dynasty was established. It reigned gloriously for many thousands of years, until the sinking of Poseidonis, when the Egyptian people were driven to the hills by the flooding of Egypt. The flood, however, retreated comparatively soon, and the country soon recovered.

Manetho's history apparently deals with this Âryan dynasty ; he gives the date of Unas, the last King of the Fifth dynasty, as B.C. 3,900, but occult research makes it B.C. 4,030. Under the Âryan Pharaohs the Schools of Egypt became even more famous, and for long led the learning of the world. From Egypt Aryan blood was introduced into several East African tribes.

The Manu sent out also from the South Indian Kingdom colonists to Java, Australia and the islands of Polynesia, which accounts for the Âryan strain to be observed even to-day in the brown Polynesians, in contradistinction to the Melanesians.

Meanwhile another emigration of the Root-Stock settled in the Punjâb. Another established itself in Assam and northern Bengâl. One expedition took place in B.C. 17,520, part reaching its destination safely by the route followed by Mars in B.C. 18,875, while a smaller part was annihilated while trying to penetrate the Khyber Pass.

In B.C. 17,455 Mars led out yet another, consisting of the strongest and most vigorous men he could find. Settling the women and children in a strongly entrenched camp between Jammu and Gujranwala, Mars went on to Delhi with his army and built the first city on that imperial site, naming it Ravipûr, City of the Sun. When the city was ready, the women and children and their guards were brought to it, and the life of Delhi, as a capital, began.

In B.C. 15,950 one of the largest emigrations began, three armies being formed under Mars as Commander-in-Chief. The left wing crossed Tibet to Bhutân and thence to Bengâl, which was to be the home of the whole expedition. The centre under Mars, with Mercury as second in command, crossed Tibet and Nepâl, to Bengâl. The right wing, under Corona. passed through Kashmîr, the Punjâb and what we now call the United Provinces; Corona spent forty years in making a Kingdom for himself and did not reach Bengâl until Mars, ruling there, was an old man. Mars, with the help of Vulcan, who had established himself in Assam; subdued Bengâl and

fixed his capital in Central Bengâl. In this far-reaching emigration ten who are now Masters took part: these were Mars, Mercury, Vulcan, Jupiter, Brhaspati, Osiris, Uranus, Saturn, Neptune, Virâj. With them were many others of the Servers.

From this time onwards there were constant descents into India from Central Asia, sometimes mere bands, sometimes large armies, the older settlers often resisting the new, the new plundering the new. During thousands of years wave after wave rolled into India.

Some of the Âryans studied the philosophy of the Toltecs, whom they sometimes called the Nâgas. The lower classes of the Atlanteans, mostly the brown Tlavatli, they termed Dâsyas, while the black Lemurians, whom they regarded with horror, they called Daityas and Takshaks.

By about B.C. 9,700 the Central Asian Kingdom was drained of its inhabitants. The convulsions of B.C. 9,564 shattered the City of the Bridge into ruins, and destroyed most of the Temples on the White Island. The latest bands of emigrants did not reach India easily, being delayed in Afghânistân and Baluchistân for some 2,000 years; and many being massacred by Mongol raiders. The rest slowly found their way down to the plains, already thickly populated.

In order to prevent the Âryan blood from being lost amidst the enormous majority of the Atlanteans and Atlanto-Lemurians, the Manu again forbade intermarriage, and to this end instituted the caste system; about B.C. 8,000. At first He founded only three castes: Brâhmana or pure Âryans, white; Râjan or Âryan and Toltec, red; and Vish or Âryan and Mongolian, yellow. Hence the castes were called Varnas or colours. Later, all those who were not Âryan at all were called Shûdras, but even here a small amount of Âryan blood sometimes appeared. Many of the hill tribes are partly Âryan, some are wholly so, like the Siaposh people and the Gipsy tribes.

In building the caste system, the Manu was helped by members of the four classes of Barhishad Pitris. (1) The sons of Bhrigu, from Globe A of the Moon Chain, having the causal body active; are the Somapâs, the Kavyas and the Saumyas; they gave their chhâyas or etheric forms for the typical Sûkshma Sharîra (subtle body) of the most advanced egos then ready for incarnation into the Brâhmana caste; (2) the sons of Angiras; the Havishmats, with mental body active, from Globe B, who gave their chhâyas for the Kshattriyas, the warrior caste; (3) the sons of Pulastya, the Ajapâs; with astral body active, from Globe C, who gave their chhâyas for the Vaishyas or merchant caste; (4) the sons of Vashishta, sometimes called the sons of Daksha, the Sukâlins, with active etheric body, from Globe D, who gave their chhâyas for the Shûdras. To the clairvoyant eye the Sûkshma Sharîra of each caste was said to be at once recognisable by its dominant colour, due to the relative density of its materials.

Returning to the movements of the Root-stock, one tribe went off by itself to a valley in the Susamir district, where it lived forgotten by the rest of the world; living a primitive pastoral

life for many centuries.

About B.C. 2,200 a great military leader arose among the Mongol tribes, who devastated all of Asia that they could reach, utterly destroying, among others, the remnants of the Persian Empire. Ultimately the Tartar leader was overthrown and his hordes scattered, but he left desolation behind him.

In a hundred years or so the Âryans in the valley migrated bodily to Persia. These were the speakers of Zend, their late arrival accounting for the curiously unsettled state of the country even in the time of the last Zoroaster. Some of the third sub-race who had escaped the general massacre came back and joined this tribe; from these beginnings developed the latest Persian Empire.

CHAPTER LIII

THE ARYAN SIXTH SUB-RACE

THE sixth sub-race of the Fifth (Âryan) Root-Race is already rapidly coming into existence in Australia and America, with isolated members of it in the older countries. Many of those who were killed in the recent war have already been re-born; though there is nothing so far to indicate that they are abandoning their former countries in order to come to the newer lands. Those of the new sub-race who remain in the old countries will probably have more difficulties to face, because of the pressure of old ideas and conservative customs.

Many members of the present Theosophical Society will be born into the new race, whilst others will prefer to remain and help to bring the fifth sub-race to perfection; others again will go with the great geniuses who will come into the Fifth-Race at its highest point. It is possible that the sixth sub-race in its manhood will be able so to influence the fifth sub-race that, for the first time; a race shall have a serene and dignified decline into fruitful and venerable age. That may be the reward of the fight being waged against the powers of darkness, opening up possibilities such as the race has never known before.

The form of body, emotions and mind have; of course, to be modified to suit the new sub-race. Already the modelling power of the Manu's mind and will is at work on the inner planes, modifying the physical type of the children of the new age, wherever they may be susceptible to it, whilst some of the junior members of the Brotherhood, working in the outer world, have instructions to provide for these when possible the education and training that befits the new type. This work, small as yet, is destined to swell to enormous proportions; until within a few centuries the sixth sub-race will stand out distinct and admirable, while the world continues to develop the fifth sub-race to its maturity.

The new race has of course to be built out of the fifth sub-race; the new characteristics required being developed one by one in the egos concerned. The process of preparation is long; and may well extend over several lives.

Even at its culmination the type will not be uniform. In the main it is to be a dolichocephalous race; but it will contain fair-haired and dark-haired people, people with blue eyes and people with brown. Whilst the astral and mental traits are the more important, in most cases it is only by the physical appearance that one can make an estimate. Perhaps the most marked physical tokens are delicate, well-shaped hands and feet, thin fingers and oval nails, especially thinness in fingers and thumb when seen edgewise. The texture of the skin is clear, never coarse. There are three types of face: the markedly oval with high forehead, the slightly less oval with broad forehead, and the practically brachycephalous, this last being rare. (N.B. A brachycephalous skull is one of which the breadth is four-fifths

of the length.) There is also a distinguishing *expression* which one who looks for it will soon begin to recognise.

The following remarks were made by Captain Pape in an address to the British Association in 1923, dealing with what he called the Austral-American Race: "The head tends to be dome-shaped, especially over the frontal region; there is a departure from what is known as the "low-set ear"; hair and skin are fine; eyes luminous, intelligent, but not full; bridge of the nose early developed; tips sensitive and mobile; eye-brows prominent; frontal brain development large; type of face somewhat triangular, but not sharp; general physiology harmonious, proportionate, healthy, not at all the "all brain and no body" type. The psychology of the new-race child manifests as a rapid response to sympathy, pity in suffering, power to comprehend principles easily; quick intuitions; thoroughness, sensitiveness, quick sense of justice, absence of parrot-like intelligence; eagerness to help others. They also show a dislike of coarse food, and often have not a large appetite along any lines. In other respects they are normal children, but specially need sympathy and understanding teachers."

A special mark of the consciousness is the recognition of unity, the quality we name Brotherhood, which makes for compassion and self-sacrifice. It is essentially the qualities of the spirit that are needed, so that though there may be less intellectual development, that is not what is mainly required; for the spirit unites what the intellect divides. Growing out of this, there will be breadth and liberality of tolerance. All that is narrow and exclusive; all that tends to separate one from another, that emphasises differences instead of likenesses, will be the antithesis of the new consciousness.

The nervous organisation will be more delicate, but not necessarily unhealthy; but, being so delicately poised; it is more subject to jar and injury, so that a child may be readily thrown out of balance, and suffer quite abnormally. Hence an environment gentler and more harmonious than that usually to be found, for example, in many large cities to-day, is most desirable for children of the new race. The separative conditions of competition, struggle, class, individual and trade antagonism - all these are destructive to the development of the new and finer nervous organisation, for which something more harmonious will have to be found in order that the new type may develop satisfactorily.

The essence of action in the sixth sub-race will be the union of many to achieve a single object, not the dominance of one who compels others to his will. Those who lead will do so, not by the exercise of will, but by love, sympathy and comprehension. Tenderness will be the mark of power, and working with rather than against others. The forerunners of the sixth sub-race will display a synthesising spirit, being able to unite diversity of opinion and of character, able to gather round them the most unlike elements and blend them into a common whole. The presence of weakness, which in the fifth sub-race is so often

provocative; and calls out impatience, will evoke instead tenderness and protection. The feeble, sentimental sympathy that comes with a poor and undeveloped nature is not compassion; it has no power of healing in it, and no power of protection. True compassion is able to give help, feeling being guided by knowledge, the remedy being shaped by understanding. This will be, as said, a prominent characteristic of the sixth sub-race.

The new race will possess certain psychic powers, and for this the pituitary body will be developed, thus giving an additional sense, that of cognising astral emotions in the ordinary waking consciousness.

We may say, in general, that the sixth sub-race will bring in intuition and wisdom, blending all that is best in the intelligence of the fifth sub-race and the emotion of the fourth.

It was mentioned at the beginning of this chapter that many of the new sub-race will be drawn from the ranks of the Theosophical Society. The great object of that Society is not so much to provide for mental development, although that has its own importance, as to awaken responsiveness to buddhic influences, when intuitional love will produce harmony and brotherhood, and will employ the developed intellect to build a new civilisation, based on such ideals. The Society, being in close sympathy with higher planes, is very sensitive to the forces liberated when another "Son of Man," or World Teacher, comes to deliver His message. It receives the first touch of this great outrush, and this gives it new impetus. Its work will increase and spread, this being reflected both in increased numbers and in brotherly feelings.

CHAPTER LIV

THE SIXTH AND SEVENTH ROOT-RACES

IN accordance with the general plan, the sixth Root-Race will be created from the sixth sub-race of the Fifth Root-Race. It will eventually take possession of a continent, now rising slowly, fragment after fragment, in the Pacific. Many thousands of years hence North America will be shattered into pieces, the western strip; on which the Sixth Root-Race will be founded; then becoming an easternmost strip of the new continent.

Whilst the little colony, which will be the germ of the new Race, is being founded, the Fifth Race will be at its zenith, and all the pomp and glory of the world will be concentrated therein. The colony will be a poor thing in the eyes of the world, a gathering of cranks, slavishly devoted to their Leaders.

Mars (now the Chohan Morya) will be the Manu of the Sixth Race; and Mercury (now the Chohan Koot Hoomi) will be the Bodhisattva.

Besides its primary object of spreading occult truth throughout the world, the Theosophical Society has also the secondary object of acting as a net to draw together those people who are sufficiently interested in occultism, and possess the necessary somewhat special qualifications, to help the Manu in the founding of His new Race. Rigorous self-training will be necessary, involving supreme self-sacrifice and self-effacement; as well as complete confidence in the wisdom of the Leaders.

Students of occultism are aware that it is sometimes possible; by means of a high type of clairvoyance, to see the future; occasionally in considerable detail. Bishop C. W. Leadbeater states that by means of this faculty he was able to see a good deal of the circumstances of the founding of the Sixth Root-Race Colony. He gives in *Man Whence How and Whither?* an exceedingly interesting and full account of what he saw; and from that account the present chapter has been compiled. The description given here is very much condensed, so that those who wish further details must refer to the original account. The colony or community will be founded in Lower California, about 700 years hence. A large and beautiful estate will be purchased and, under the supervision of the Manu and His lieutenants, a magnificent group of buildings will be erected; they will comprise a central Temple or cathedral, vast buildings arranged as libraries, museums and council-halls, with perhaps 400 dwelling-houses surrounding them. Much complicated machinery will be installed, the colonists soon learning how to make and repair everything they need, thus becoming independent of the outside world. The community, however, keeps in touch with the rest of the world, acquainting itself with all new discoveries, inventions and improvements in machinery.

The Manu Himself incarnates, in order to set the physical type of the Race and bring it into line with the thought-form of the Logos for the Sixth Race. After about 150 years the community

numbers about 100,000, all of them, with a few exceptions, direct descendants of the Manu. The Manu Himself has twelve children, one born under each sign of the Zodiac. Large families are the rule, there being no infant mortality.

The community pays a nominal tax to the general government of the country, and in return is left almost entirely alone, since it soon becomes self-supporting. It is popularly regarded with great respect, the life of its members being considered beautiful and interesting, but unnecessarily ascetic and somewhat curious. Visitors are permitted, but no member of the colony may intermarry with a non-member.

The people of the community are a selection of a selection; they are perfectly aware of and utterly devoted to the work of their Manu and Leader - the founding of the new Race. In Him they have the fullest possible confidence, and they have thoroughly trained themselves to put aside their own personalities in order that they may carry out His wishes wholeheartedly.

The Manu's rule is undisputed; He has a Council of about a dozen highly-developed pupils, some of them already Asekha Adepts. New experiments are constantly being made to increase the welfare and efficiency of the Race. All Council members can function freely on the lower planes, at least up to the causal body. They are therefore in perpetual session, consulting even in the very act of administration.

Neither courts of law nor police exist, for there is no crime or violence. The only punishment would be expulsion from the community, and no one would run the slightest risk of incurring such a penalty. As everyone has at least some degree of psychic development, all can see for themselves something of the working of the forces with which they have to deal, and the enormously greater advancement of the Manu and other Leaders.

The religious opinion current is what we now call Theosophy, much of our present rudimentary knowledge being now thoroughly understood in detail. The facts of the life after death and the nature of the higher worlds are matters of experimental knowledge for nearly all. Some follow higher philosophy and metaphysics, but the majority prefer to express their religious feelings in the different Temples, which will presently be described. The people are essentially practical, their science and their religion being in perfect accord, bent to the one object of serving the State. Many salute the rising Sun, but regard him as a centre in the body of the Deity.

Devas take part in their religious life and habitually come among the people, who derive much benefit from the constant intercourse and instruction the Devas afford. The Devas, in fact, work regularly under the Chief Priest (the present Chohan Koot Hoomi), who is in supreme charge both of religion and education. There are four types of Temple services, the management of these being the especial function of the Devas.

The keynote of the Temple services is to provide each man with that avenue of expression through which he can most easily reach the Divine, and can be most easily reached by Divine

influence. The four kinds of Temples work through affection, devotion, sympathy and intellect respectively. The object is to bring the prominent quality in the man into active and conscious relationship with the corresponding quality in the Logos; of which it is a manifestation. Every service is intended to have a definite and calculated effect upon the man, the services for a year or series of years being carefully ordered with a view to the average development of the congregation, and with the idea of carrying its members upward to a certain point.

The Crimson or affection Temple works principally by colour, and affects mainly the astral and buddhic bodies of the worshippers. It is circular, and to a great extent open to the outer air. The worshippers sit on the pavement, close their eyes, and pass before their mental vision a succession of colours, each person having an order of his own. This corresponds to a preliminary prayer, and is intended to calm the man, collect his thoughts, and attune him to the surrounding atmosphere. When the service commences the Deva materialises, in a glorified human form, and wearing rich crimson vestments, on the apex of a pyramid or conical erection of filigree work in the centre of the building.

The Deva then causes to flash above his head a band of brilliant colours; which is a thought expressed in the colour-language of the Devas, and serves as the text or keynote for that particular service. It is intelligible as well as physically visible to the congregation.

Each person now imitates the Deva's colour-band, making a smaller copy of it in the air in front of him. The Deva then pours out a stream of influence, through his own colour-form, which reaches each worshipper and Uplifts him through his own smaller colour-form. Through the officiating Deva is also poured a stream of influence from a ring of higher Devas. A sea of crimson light suffuses the vast aura of the Deva, spreads over the congregation, and stirs their emotions to greater activity, evoking the highest affection of which they are capable. The Deva next reverses the current of his force, drawing all the fiery streams into himself and passing them as one vast fountain to the circle of waiting Devas; who again pass it on to the chief Deva of their Ray.

The chief Deva collects similar streams from all parts of the world, and combines them into one great river which flows around the Feet of the Deity. The Logos instantly responds, sending a flood of power through the chief Deva to the people in benediction. This, very briefly, is the daily religious practice, affecting for good not only the individual worshippers, but also the surrounding district. Sometimes also the Deva delivers a sort of colour-sermon, mostly without spoken words, passing the colours through a series of mutations, and showing the effect of love upon other people. Incense of various kinds is used throughout the service; acting mainly upon the etheric bodies.

The Blue or Devotional Temples work principally with sound, the general procedure being very similar to that in the Crimson

Temples, with music instead of colour as the predominant element. Each person brings his own specially-magnetised instrument, somewhat like a circular harp with strings of shining metal, upon which he plays and through which he receives spiritual influence. The whole atmosphere is surcharged by the Gandharvas or music-Devas, so that every sound is multiplied, and for every tone a great chord of overtones and undertones, all of unearthly sweetness and beauty, are created. The Blue Temple services affect principally the astral and buddhic bodies of the people.

In the Yellow or Intellectual Temples a service of identical structure is performed, built upon the creation of mental forms or images, the effects being produced mainly on the mental and causal bodies of the worshippers, who give themselves in surrender to the white heat of intellectuality raised to its highest power. By intensity of intellectual activity the worshippers attain first a mental understanding, and then by intense pressure break through into the world of the intuition; some actually leaving the body, others passing into a kind of Samâdhi.

In all the Temples great emphasis is laid on the training of the will, the effect being prominently shown by the intense glow of the causal bodies; it reacts also upon the mental bodies and even the physical brain, which appears to be distinctly larger than with men of the Fifth Race. The Sympathy or Green Temple may be considered as that of the Karma-Yoga, as the Blue and the Crimson represent the Bhakti-Yoga, and the Yellow the Jñâna-Yoga. The Green Temple service is concerned with practical activity, the worshippers working with plans for helping the world in numerous ways, and is under the guidance of the line of the Healing Devas.

Each man, as said, works through the particular Temple that appeals to him most; there being no difference in advancement between those who follow one line and those who follow another. The habitual attendants of one Temple, moreover, occasionally visit the others. A few people do not attend any of the Temples, but are not on that account considered irreligious or in any way inferior to the most regular attendants. It is simply a matter of temperament; and there is complete freedom and tolerance.

The Chohan Koot Hoomi, who, as said; is in charge of the whole of the religious and educational life of the community, visits all the Temples in turn, and takes the place of the officiating Deva.

In the community, education is considered of paramount importance. All sorts of adjuncts are employed; such as colour, light, perfume, sound, form, electricity, and the Devas who take such a large part in the work use armies of nature-spirits. All teachers must be clairvoyant, and are men and women indiscriminately. Devas frequently materialise to give certain lessons, but do not seem to take sole charge of a school. All the people being immediate reincarnations, most of them have some memory of their past lives, so that even tiny children are fully aware of the purpose of the community, and endeavour to get

control of their new vehicles as quickly as possible.

Great attention is given to the training of the imagination, and visualisation is practised very thoroughly. Arithmetic is greatly simplified, the decimal system is universally employed; and practically all calculation is done by books of tables or by calculating machines. Spelling is phonetic, and writing something like short hand, which can be written at least as fast as an ordinary person can speak. The language is English, though much modified. Nobody learns history, except isolated interesting stories, but in every house is an epitome of all history. Geography is learnt to a limited extent, chiefly with reference to races and their characteristics. No one, in general, troubles to learn what can be turned up in a moment in a book of reference, the scheme being thus strictly utilitarian.

A boy of twelve usually has in his brain the entire memory of what he knew in his previous lives, talismans being used to help the child to recover his memory of past lives.

There are children's services in the Temples; in which they sing and play on instruments whilst performing graceful evolutions. They also perform on an open plain a representation of the movement of the planets round the sun. Whilst they thoroughly enjoy this, they fully recognise that it is a religious function. Another dance indicates the transference of life from the Moon Chain to the Earth Chain. All sorts of instruction is given to the children in this way, half a play and half a religious ceremony. The children are dressed in delicate yet brilliant hues, performing complicated evolutions requiring much training in drill, yet they are most enthusiastic about it. Education and religion are thus so closely mingled that it is difficult clearly to differentiate one from the other.

Parentage is a matter of arrangement between all parties concerned, and death is usually voluntary. Disease has been practically eliminated, so that except for rare accidents no one dies save of old age, and they do not drop the body as long as it is useful. Nobody appears old until at least eighty, and many pass beyond the century.

When a man feels his powers are waning he selects a father and mother whom he thinks would suit him; if they agree, he hands them his personal talisman, and sends to them any personal effects he wishes to carry over to his next life. The personal talisman is usually a jewel, fully impregnated with the magnetism of the man, and correspondent to his name as an ego - a name in many cases used in ordinary life. When a man wishes to cease living, he merely loses the will to live, and generally passes away peacefully in sleep within a short period of time. Often he takes up his abode with his prospective parents and dies at their house.

There is no funeral ceremony of any kind, nor do friends assemble. The body is placed in a retort and reduced to a fine grey powder by means of an acid and a power resembling electricity.

As a general rule people are karmically free to choose their

next birth, though in rare cases the Manu may alter the plan, if He does not approve of it.

Parents usually arrange to have ten or twelve children, generally the same number of boys and girls, there being usually an interval of two or three years between successive children, and twins or even triplets being not uncommon. No cripples or deformed persons are to be seen, there is no infant mortality, and the labour of child-birth has diminished almost to vanishing-point.

People fall in love and marry for life much as now, though even in such matters duty to the community is stronger than personal preference. Ordinary sex passions have been dominated, the creation of healthy bodies for children being regarded as a religious and magical act, and marriage as an opportunity to that end.

Marriage takes place only with the sanction of the Manu and is regarded almost entirely from the point of view of the prospective offspring. Often a pair who wish to marry have two or three egos waiting to incarnate in their future children. Marriage is monogamous, there is no divorce, though the agreement is always terminable by mutual consent. In most cases it is continued for life, but if it ceases either party is free to form other alliances. The strongest ties are probably between parents and children. People of the same type do not usually marry, unless it is desired to produce children for training by Devas for a particular Temple.

The greatest honour of all is to be born in the family of the Manu, but of course He selects His children Himself.

The Council consists only of men and, under the direction of the Manu; its members are making experiments in the creation of mind-born bodies.

The Race is white in colour; though some have darker hair and eyes and a Spanish or Italian complexion. None of the men are under six feet, and the women are nearly as tall. All are muscular and well-proportioned; and preserve a free and graceful carriage even to extreme old age.

The settlements, each with its Temples, public buildings and schools, consist of groups of villas thinly scattered amidst parks and gardens.

The houses and other buildings are usually entirely open to the air, though the spaces between the pillars supporting the roof may be closed by a substance which can be made transparent at will. Domes of many shapes and sizes are a prominent feature. Nowhere are there corners, all rooms being circular or oval. Every house is full of flowers and statues, and there is abundance of water everywhere. At night the domes of the houses are made to glow out in a mass of light, the colour of which can be changed at will.

There is very little furniture, the people sitting and sleeping on cushions on the floors; which are of marble or other polished stone.

Clothing is simple and graceful, somewhat like that of India

or ancient Greece; it is exclusively linen or cotton, brilliant and delicate colours being worn equally by both sexes. Nothing is worn on the head or the feet, as a rule.

The community is entirely vegetarian, and mostly takes its meals in open-air restaurants. Fruit, which is extensively cultivated, is very largely eaten, as well as prepared foods which can be had in many colourings and flavourings.

Enormous quantities of sea-water are distilled and then distributed on a liberal scale. The necessary chemicals are added to make the distilled water fresh, sparkling and thirst-quenching.

In each house a permanent fitting is a comprehensive encyclopædia containing an epitome of practically all 4~ that is known, expressed tersely and yet with much detail. In the district libraries, attached to each Temple, is an even fuller encyclopædia, containing an epitome of every book written on each subject. In the central library, which is on a scale commensurate with the British Museum; may be found the original books in the old languages as well as English translations in the abbreviated script of the day.

The daily newspaper is replaced by a machine which M is a combination of telephone and recording tape-machine. Important news is sent, in epitome, to each house, and anyone can obtain full information on any item by ringing up the central office, all that is available being then sent along the wire and printed in the house. The same instrument is used for adding slips to the household encyclopædias.

The Manu sometimes promulgates edicts or information by speaking in the central Temple, His words being reproduced in all the other Temples simultaneously.

Study, of animals or plants, for example, is done never by destruction, but by clairvoyance. In the museums are life-size statues of all races of men which have ever existed on the earth, and also of those on other planets of this chain. With each statue is a full description, with diagrams, showing in what way the higher vehicles differ. Much of the future also is shown, with models.

As there is no illness, there is no medical department, though there is surgery for the rare cases of accident.

There is an elaborate museum of every kind of art and craft that has ever existed; with models of every kind of machinery, including much of Atlantean times.

History is being written direct from the Âkâshic Records, and illustrated by a precipitation of important scenes from those Records. There is a machine which reproduces audibly and visibly any scene from history that may be required.

Astronomical observatories exist, and also instruments indicating the positions at any moment of the heavenly bodies. Much astronomical information has been given by Devas, though this is kept distinct from that obtained by direct observation.

Chemistry has been enormously advanced, and includes the elemental essence, this leading on to the department of nature-

spirits and Devas. In the talisman department any sensitive person can by psychometry go beyond the models and see the things in themselves.

Lecturing is largely replaced by printed information. Painting is done only as a recreation. All life is permeated by art, even the simplest objects being beautifully made. There are no theatres, the histrionic art being considered archaic and childish. The choric dances and processions are regarded rather as religious exercises.

Games, athletics and gymnastics are much practised, both by women and by men.

Much is done by the direct power of the will, and nature-spirits take a prominent part in the life of the community. Messages are sent telepathically, chiefly by children, who are usually more proficient in the art than adults.

As already said; the community is practically self-supporting, importing only ancient manuscripts, books and objects of art; these are paid for with money brought into the community by outside tourists and visitors, as the community does not use money for its own internal purposes. Jewels and gold are made alchemically, and are sometimes used also to pay for imported articles.

Everyone is free to choose what work he will do for the community. Education is free, but university training is provided only to those who can benefit by it and need it for the work they propose to undertake.

Each person receives a number of tokens entitling him to food and clothing. Machinery is so perfect that, in the cloth factories, for example, it is almost silent, and is operated chiefly by young girls.

By this time the whole world has given up the use of heat to generate power. At first the whole water-power of the earth was utilised to generate electricity, which was then transferred for enormous distances without loss. Later this was superseded by a method of utilising the force in physical atoms - the force that Keely called dynaspheric force - which is supplied free and in unlimited quantities to everyone all over the world; for all possible purposes. Dirt has been practically eliminated, so that factories are as beautiful and clean as private houses.

Three hours is considered a fair average day's work; the machinery is very largely automatic. In the restaurants there is a system of relay for the staff. Even cooking is mainly automatic and a matter of pressing knobs and switches.

Mean or dirty work no longer exists, and no work is considered inferior to any other. Mining has been given up because nearly anything can be made alchemically. Many new alloys have been invented.

All agricultural work is done by machinery, largely automatic; even machinery is made by other machinery. Instead of drains, each house has a chemical converter which reduce everything to a grey powder, something like ashes. There are no servants, as there is practically nothing for them to do. When

required, people help one another.

There is little private property, the principle of the community being to enjoy things, not to own them. But if a man wishes to procure anything for himself he can earn the means of doing so by working for the community.

Roads are scarcely streets, but drives through the park. The roadway is made of one piece, the surface being beautifully polished stone, with a grain like granite and a surface like marble. Some are pale rose colour, others pale green. They are flooded with water every morning and so kept spotlessly clean.

As there is nothing but polished stone and grass; people go barefooted; there is a shallow trough of running water at the entrance of every building to cleanse and cool the feet.

Every house possesses several light metal filigree vehicles, somewhat like bath-chairs, with highly elastic tyres. They run at high speed with perfect smoothness, and are of course driven by the universal power, obtained by charging up from power-taps. There is little heavy transport. Although the rest of the world uses flying machines, the community rather despises aerial locomotion, feeling that they should be able to travel instead in their astral bodies. At school they receive a course of lessons in the projection of the astral body.

The climate is almost ideal; there being no real winter. Flowers are universally cultivated, the whole country being irrigated even where it is not cultivated. Plants which require additional heat are surrounded with little jets of the power in its heat form.

Enormous advances have been made also by the rest of the world. Europe has become a Confederation, with a central body of representatives, which adjusts matters, the Kings of the various countries being its Presidents in rotation. These changes were brought about, some time in the twentieth century, by a reincarnation of Julius Cæsar, whose work to a great extent coincided with that of the World Teacher. Cæsar persuades all countries to give up war and to spend the money, previously spent on armaments, on social improvements, which include the abolition of all slums and the introduction of great improvements in all cities. He has to help him an exceedingly capable band of people, reincarnations of Napoleon, Scipio Africanus, Akbar and others. For the preliminary meeting of the Confederation he builds a circular hall with many doors, so that all may enter at once, no one Potentate taking precedence of another.

All this becomes possible largely on account of the new era opened by the arrival and preaching of the World Teacher. The religion of the world now is founded on His teaching, though there are still some survivals of the older religions, which are looked upon generally as rather out-of-date. The general state of affairs is greatly improved; there is a small force used only for police purposes; poverty has practically disappeared; slums are replaced by parks and gardens.

The altered English, written in a kind of shorthand with many grammalogues, is the universal commercial and literary

language, and is rapidly superseding the tongues of the different countries. Most books, for example, are printed in it, including translations of all specially good books written in other languages.

In the community, books are printed on pale sea-green paper in dark blue ink, being less trying for the eyes than black on white, and the same plan is being adopted all over the world. Civilised rule has spread all over the world; so that there are no real savages to be seen.

Each nation still thinks of itself with pride, but they no longer fear one another; there is no suspicion, and therefore far greater fraternity. Crime is much reduced, because people know more, but chiefly because they are much more content.

The new religion has spread widely, and its influence is strong; it is entirely scientific, so that religion and science, though separate, are no longer opposed. People discuss the different kinds of spirit-communion, and quarrel as to whether it is safe to listen to any spooks except those authorised and guaranteed by the orthodox authorities of the time.

Schools exist everywhere, but not under the control of the Church, except those for training preachers. There being no poverty, there is no need for philanthropy. Hospitals are Government institutions. All necessaries of life are controlled, so that there are no serious fluctuations in their price. Luxuries, objects of art, and so on, are still in the hands of private trade. Much of the land is held nominally from the King; it may descend from father to son, but only with the consent of the authorities. Mining is much reduced, many of the old mines in the north of Europe being used as sanatoria for consumption or bronchial or other affections; because of their equable temperature. Metals are raised from great depths, nearly all the work being done by machines. Iron is obtained with much less trouble than previously.

In England all real power is in the hands of the King; there is no parliament, but there is something of the nature of the referendum. Everybody has the right to make representations, which receive prompt attention. The monarchy is still hereditary, the British Empire acknowledging the one King. Some Colonial Governors hold their offices by heredity and are like tributary Monarchs.

Fires and smoke have been abolished everywhere. Most things seem to be supplied on the principle of turning on a tap, thanks to the introduction of the universal power. Cities, though larger, are much looser; there being many more parks and gardens. The irrigation system in Holland has been enormously improved, the whole of the water being changed every day and exhausted far out to sea. Dyes, foodstuffs and other articles are obtained by distillation of sea-water. Tropical trees are grown in the streets, kept warm by a flow of the power in its heat aspect.

The streets were at first roofed and warmed; but when the unlimited power was introduced the roofs were abolished. China does not seem to have changed its civilisation very much, though

there is a good deal of superficial change.

India also has not changed much fundamentally, the immemorial village being still a village; but there are no famines. The country is grouped in two or three big kingdoms, but is still part of the British Empire. There is much more intermarriage with white races and the caste system has to a great extent broken down.

Tibet has been opened up, and is accessible to flying machines, though even these sometimes have difficulties owing to the rarity of the air at a great height.

Central Africa has become a sort of Switzerland with many great hotels. The Theosophical Society still exists, and devotes itself principally to its second and third Objects; the first having largely been achieved. It has a great central University, with subsidiary centres in various parts of the world. The present Headquarters building is replaced by a gorgeous palace with an enormous dome, the central part in imitation of the Tâj Mahâl; but much larger. There is a special department for occult chemistry, with beautiful models. *The Secret Doctrine* still exists, transcribed into the universal language.

The Society is a distinct department in the science of the world, having a long line of specialities which no one else seems to teach. It turns out a vast amount of literature, and keeps alive interest in the old religions and in forgotten things. It is issuing on a magnificent scale a vast series of text-books somewhat resembling the "Sacred Books of the East" of our day. The literary department is enormous, and is the centre of a world-wide organisation. Adyar is still the centre of the work and is a place of pilgrimage. Colonel Olcott; a lieutenant of the Manu and working in California, is still the nominal President of the Society, and visits the Headquarters at least once every two years. In spite of the fact that practically all the 100,000 members of the Community have passed through the Theosophical Society, there is still a huge Society left to carry on the work at Adyar and in the other centres all over the world.

In the life of the Community, there will be scope for the keenest intelligence, the greatest ingenuity and ability in every direction. But all these will be useless without the capacity of instant obedience and utter trust in the Masters, Who arrange the whole plan and guide everything with watchful care.

Those who join the Community will have to incarnate over and over again in rapid succession, trying each time to bring their bodies nearer to the model set before them by the Manu. This is a laborious and trying piece of work, but absolutely necessary for the establishment of the new type of humanity which is required for the Race.

The opportunity of volunteering for this work is now open to all.

The above is an account merely of the beginnings of the sixth Root-Race; it bears much the same proportion to the life of the whole Race as the gathering of the few thousands on the shore of the sea that washed the south-eastern part of Ruta bore to the

great fifth Root-Race that is now leading the world. It is not known how long it will be before America will be rent in pieces by earthquakes and volcanic outbursts; and a new continent will be thrown up in the Pacific to be the home of the Sixth Race. Gradually will the new continent be upheaved, and the land that was once Lemuria will arise from its age-long sleep and once more lie beneath the rays of the sun; for the continent of the sixth Root-Race will occupy, roughly, the Lemurian site.

The sixth Root-Race will of course have its seven sub-races, and from the seventh sub-race will be chosen the germs from which will be created the seventh Root-Race. This, of course, will be the work of the Manu of the seventh Root-Race, and He will also arrange for the usual seven sub-races in His Root-Race. But of that work nothing is as yet known. The seventh Root-Race will be especially concerned with the unfoldment of the Sat, or pure existence, aspect of the Divine Life, known also as the Father, the Creator and the Destroyer, to the Hindus as Matâdeva.

When the seventh Race has run its turn, the Earth will be vacated - except for the usual nucleus which is left behind - and the main life-stream will pass to Mercury. There the life will be somewhat less material than it is on the Earth, and the average level of consciousness may be somewhat more extended; since ordinary humanity will then possess what is now called etheric sight.

From Mercury the life-stream will pass, in the usual course, to Globes F and G. After that again the fifth round will commence; to be followed in due course by the sixth and seventh rounds, after which our earth chain will vanish, to be succeeded by another chain - the fifth of the series.

CHAPTER LV

LIFE ON MARS AND MERCURY

THE condition of Mars at present is by no means unpleasant. Being smaller than the Earth, it lives its life as a planet more quickly. When humanity occupied it in the third round, there was much more water than land on its surface. Now, in its comparative old age, there is far less water surface than land. Large areas are now desert, covered with bright orange sand, which gives the planet its peculiar hue. If irrigated, these deserts would probably be fertile enough.

The present small population consists practically of members of the inner round, and they live in the equatorial lands, where the temperature is highest and there is plenty of water. Whilst, as we have seen, many of the more advanced members of our present humanity were not on Mars when the life-stream last swept over it, yet the great bulk of the human race passed through a series of incarnations on the planet, leaving behind many traces of their occupation, of which the present inhabitants abundantly avail them selves.

The canal system was constructed by the second order of moon-men when they last occupied the planet, and brings the water from the annual melting of the fringe of the polar snow-caps. The double line, some times seen by astronomers, is due to a second parallel canal built to receive any possible overflow from the main canal. The canals themselves are not visible from the earth; what is seen is the belt of verdure on each side of the canals. In the inhabited portions of the planet the climate is very good, the day temperature being usually about 70° Fahrenheit, though there is generally a touch of frost at night. Clouds are almost unknown, so that there is very little rain or snow.

The Martians are not unlike ourselves in appearance, though most of the men are two or three inches under five feet in height. They are somewhat broad in proportion, with great chest capacity. There are blondes and brunettes, some having a faintly yellowish skin and black hair, while the majority have yellow hair and blue or violet eyes.

They dress mostly in brilliant colours, having the feet usually bare, though sometimes covered by a metal sandal or slipper. They are very fond of flowers; their towns being garden-cities; the houses of one storey only. The walls are built of something like coloured glass, so fluted that those inside can see clearly to the outside, but people outside cannot see into the houses.

The houses are constructed of a material which is poured into a mould and left till it sets. Doors run back into the walls on each side; and are of metal; like all furniture and fittings.

They have one language only, which has been simplified to the last possible extent. They speak into a box, something like a telephone; the mechanism recording what has been said upon a small metal plate, which can be read by those who understand the

script. Writing by hand is vastly more difficult, the script being a very complicated shorthand. Books are printed in this shorthand, on flexible metal rolls, in minute type which is read by means of a magnifier, the scroll being automatically unrolled at any desired rate.

Electricity is the sole motive power; and laboursaving machinery of all sorts is universally employed. The people are, on the whole, distinctly indolent; much of the work is done by domestic animals very highly trained.

One autocratic ruler governs the whole planet; but the monarchy is not hereditary. Polygamy is practised, but all children are handed over to the State to be reared and educated, and most people do not know who are their parents. The children are carefully sorted and trained according to their aptitudes, the most capable being trained to become members of the ruling class. From this class the King chooses all officials and appoints his successor.

Disease has been eliminated, and they hardly ever even feel old. When the desire to live fades away a man dies. Sometimes, at his own request, he is painlessly put to death.

The people have absolutely no religion; there are no churches, temples, priests; or ecclesiastical power. Nothing is considered to be true save that which can be scientifically demonstrated, and to believe anything which cannot be so demonstrated is not only foolish but a positive crime, being a danger to the public peace. In the past the Martians, like us, have suffered from religious persecutions, and they have determined that such things shall never occur again. Hence now physical science and reason reign supreme.

Nevertheless there has existed on Mars for many centuries a secret brotherhood which not only believes in superphysical worlds but knows practically of their existence, for its members took up the direct study of mesmerism and spiritualism, and many of them developed a good deal of power. The head of the secret society is a pupil of one of our Masters. The existence of the society, which is now very widespread, is not known officially to the authorities, though they suspect its existence and fear it. For when any of the suspected persons have been injured or unjustly put to death it has been noticed that the persons concerned in bringing about that result have died prematurely or mysteriously. It has consequently come to be understood that it is safer not to interfere with the suspected persons, so long as they do not openly profess anything which could be considered subversive of the good morals of materialism.

Some members of the secret society have learnt to cross the space which separates Mars from the earth, and have tried to manifest at spiritualistic seances, or have been able to impress their ideas upon poets and novelists.

Driven into inhospitable and impenetrable forests, there still exist remnants of the savages descended from those left behind when the life-stream left Mars for the earth. They are lower in evolution than any now living on the surface of the

earth, though somewhat resembling one of our interior evolutions.

Turning to Mercury, little investigation has been carried out so far, so that little is known. Although the sun appears at least seven times as large as it does here; the heat is not too intense, because there is a layer of gas which prevents most of it from penetrating. If a storm for a moment disturbs this gaseous envelope; the direct sunlight shines through; destroys whatever life comes in its way, and burns everything combustible.

The inhabitants are much like ourselves; though again smaller. The doors of the houses are a considerable height from the ground, but owing to the influence of gravity being less than half what it is here, only a slight spring is required to reach them. All the inhabitants from birth possess etheric sight.

CHAPTER LVI

CONCLUSION

This book brings to an end the series of five works, of which the first four were *The Etheric Double, The Astral Body, The Mental Body, and The Causal Body and the Ego*, the whole being intended to be almost an encyclopædia of what we may call the technical aspect of modern Theosophy. Throughout the series the plan has been identical, namely, to present to the student a *compilation* of the information contained in the books of the best known and accredited writers of to-day, chief among whom stand Dr. Annie Besant and Bishop C. W. Leadbeater. The whole five books have been compiled, quite frankly, in the main for those members of the Theosophical Society, and others; who recognise and accept the two occult writers named as reliable authorities on these matters. Their statements have been taken, deliberately, at their face value; as accurate and reliable, and no attempt whatever has been made to justify or prove any of them.

As mentioned in one of the other volumes; the writings of H. P. Blavatsky have been referred to only occasionally; this, so far from being any disparagement of their value, is rather a confession of weakness on the part of the compiler, who has neither the time nor the knowledge to study and sift her monumental volumes and extract from them the immense mass of information they contain. That work must be left to others better qualified.

The series of five books being, as said, essentially compilations, marginal references have been given throughout, so that the student may make any use of them he chooses. Only on very rare occasions has the compiler ventured to intrude any personal reflections or opinions of his own on the matters under consideration, though the temptation to do so has of course frequently been felt. In this, the concluding chapter of the series; he may perhaps be forgiven for adding just a very few reflections of his own, as he surveys the work that has occupied him closely for more than five years.

In considering the mass of details concerned with the material mechanism of the spiritual entity we know as man, the mind is naturally impressed by the immensity of the plan of evolution, the inexorable and stately march by which Nature attains her divine ends, seemingly regardless of labour- and time-immensities which leave our still-human imaginations breathless with wonder and awe. So greatly does Nature deal with her work, so divine is the destiny she has planned for the children she brings to birth.

Voluminous as may seem the mass of detailed information we have accumulated regarding the nature of man and of the world in which he lives, it is; as every student knows only too well, but a few grains gathered from the sands on the shores of the illimitable ocean of truth. So tiny and fractional, indeed, does it all seem that at times one is tempted to doubt whether it is

worth while to expend time and force in gathering a handful of fragments out of the virtually infinite mass of possible knowledge.

But, perhaps, it is better for us to take as our test of value, not so much the mere quantity of knowledge we can gather - that is admittedly insignificant - as its *quality*. It is the kind of knowledge; its essential nature, that can so profoundly affect our lives, and can inspire us with some notion of the incredibly magnificent future that awaits us, if we will, and that should urge us to live as the Gods we in essence are.

The value of studying the past, however remote, may even because it is so remote, and however little it may seem at first to have any "practical" bearing on the present, is admirably expressed by Hilaire Belloc in his work *The Old Road*. He writes: "To study something of great age until one grows familiar with it and almost to live in its time, is not merely to satisfy a curiosity or to establish aimless truths; it is rather to fulfil a function whose appetite has always rendered History a necessity. By the recovery of the Past; stuff and being are added to us; our lives which; lived in the present only, are a film or surface; take on body - are lifted into one dimension more. The soul is fed. Reverence and knowledge and security and the love of a good land - all these are increased or given by the pursuit of this kind of learning. Visions or intimations are confirmed. It is excellent to see the crimes we know ground under the slow wheels whose ponderous advance we can hardly note during the flash of one human life. One may say that historical learning grants men glimpses of life completed and a whole; and such a vision should be the chief solace of whatever is mortal and cut off imperfectly from fulfilment."

As to the future, the Theosophical Society has perhaps served the world in no way better than by affording knowledge of those more evolved Men whom we know as Masters. To-day, there are of course many, doubtless both within and without the Theosophical Society; who are able to confirm of their own experience what prominent occultists have stated regarding the nature of these great and lovable Beings, and the work They do for the world. Some, again, are becoming more and more able themselves to share in that work, by becoming "apprentices" of the Master-workers. The work which the Masters are doing; writes C. W. Leadbeater (*The Inner Life*, I, 540), "this work of the evolution of humanity, is the most fascinating thing in the whole world. Sometimes those of us who have been able to develop the faculties of the higher planes have been allowed a glimpse of that mighty scheme - have witnessed the lifting of a tiny corner of the veil. I know of nothing more stirring, more absorbingly interesting. The splendour, the colossal magnitude of the plans take away one's breath, yet even more impressive is the calm dignity, the utter certainty of it all. Not individuals only, but nations, are the pieces in this game; but neither nation nor individual is compelled to play any given part. The *opportunity* to play that part is given to it or to him; if he or it will not

take it, there is invariably an understudy ready to step in and fill the gap."

The student should not be misled by the necessarily fragmentary and limited scope of the occult investigations which have so far been made; into imagining that the few groups mentioned; such as the Servers, are in any sense the most important or the most significant in our evolution. These few groups are introduced into the story merely because they are the ones with which the comparatively few people who at present take interest in these matters are primarily concerned, they themselves belonging to such groups. There may be, there must be, many other groups equally or even more significant than the Servers and the few others mentioned. The Path of Service is one of the many paths; who is there who dares to say that any one path is greater or to be preferred to any other path? All roads lead to the one goal, and the Monads no doubt have their own sufficient reasons for selecting any particular path for this cycle of their evolution.

Some there are who must live to help and to serve others, for that is their nature; that is the line they, as Monads, have chosen for themselves. Others live to know, to learn all the wonders, the magic and the mystery of this incredibly marvellous universe. That, too, is their nature. Is then the God of Knowledge to be accounted less than the God of Service? Others again do not take service as their primary goal, nor do they limit themselves to acquiring and using knowledge. They seek, perhaps, to live perfectly, to express in perfection God as Life. Yet others model their lives on the ancient saying that "the nature of the Self is bliss"; they seek to help the God of Happiness to achieve His divine purpose of creating; maintaining and adding to the happiness of all beings. And then there is the Path of Love. What shall be said of that? Is it the greatest of all the Paths - at all times; and for all people? Could the universe be brought to being, developed in all its superb structural complexity, and brought to full fruition, by Love and Love alone? These are hard questions, and even here the wise will perhaps refrain from dogmatism, lest they fall into error through vision which is not yet all-inclusive.

If the possibilities of Life are infinite in majesty, in power, in love; in action, in happiness, surely there is ample scope, may even need, for some to seek perfection of Life, to become Life, to fulfil the plan of Life, by these or by any other of Life's limitless and infinitely versatile aspects.

One last word of apology. In a work of this nature, involving close application to detail, and at the same time covering an immense field, wrought out alone and unaided, mistakes, both of commission and omission; must inevitably have occurred. Should any student detect any of these, would he be so kind as to inform the compiler, so that, in the event of future editions; the errors may be set right?

A. E. POWELL.

